

A hand holding a mobile phone in front of a television. The phone's screen shows a video player interface with a play button and progress bar. The television in the background is also displaying a video player interface with a play button and progress bar. The background is a blurred room with a light-colored wall and a wooden floor.

Development of Mobile TV standards in DVB

Jukka Henriksson
DVB AHG TM-H chairman
Nokia

FRUCT seminar
November, 2009
Helsinki-Espoo

Outline

1. DVB & History
2. DVB-T
3. DVB-H
4. DVB-T2
5. NGH
6. Conclusions



DVB

The DVB Project

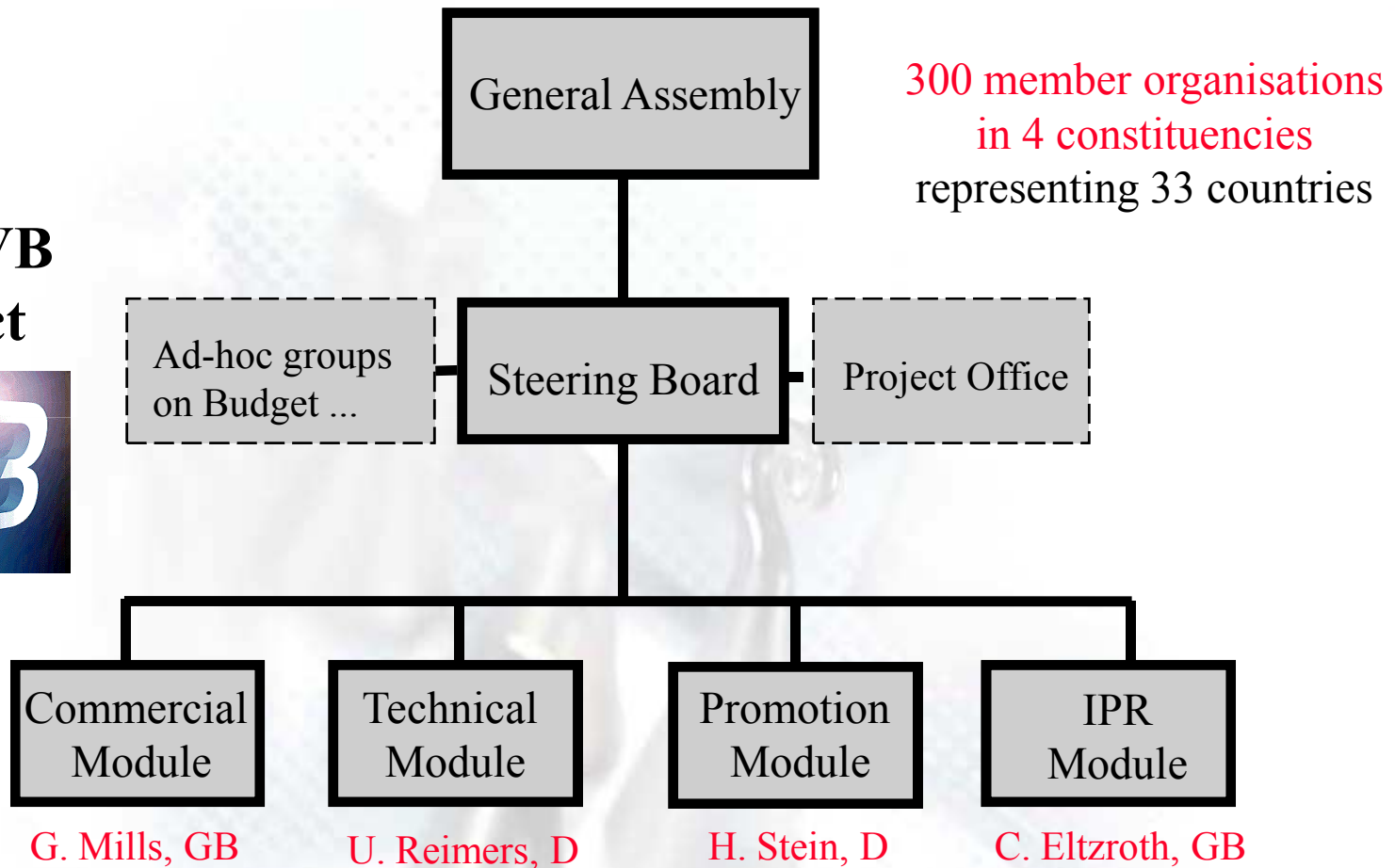

From DVB-T to DVB-H

(Nokia-centric view 😊)



From DVB-H to DVB-NGH



N96

NGH
Study
mission

NGH
Std work
starts

DVB-NGH
(Or DVB-H2?)
Commercial
launch



?



DVB-T2 work started
Study mission



EN 302 755
DVB-T2

DVB-T

COFDM based DVB-T is the basis

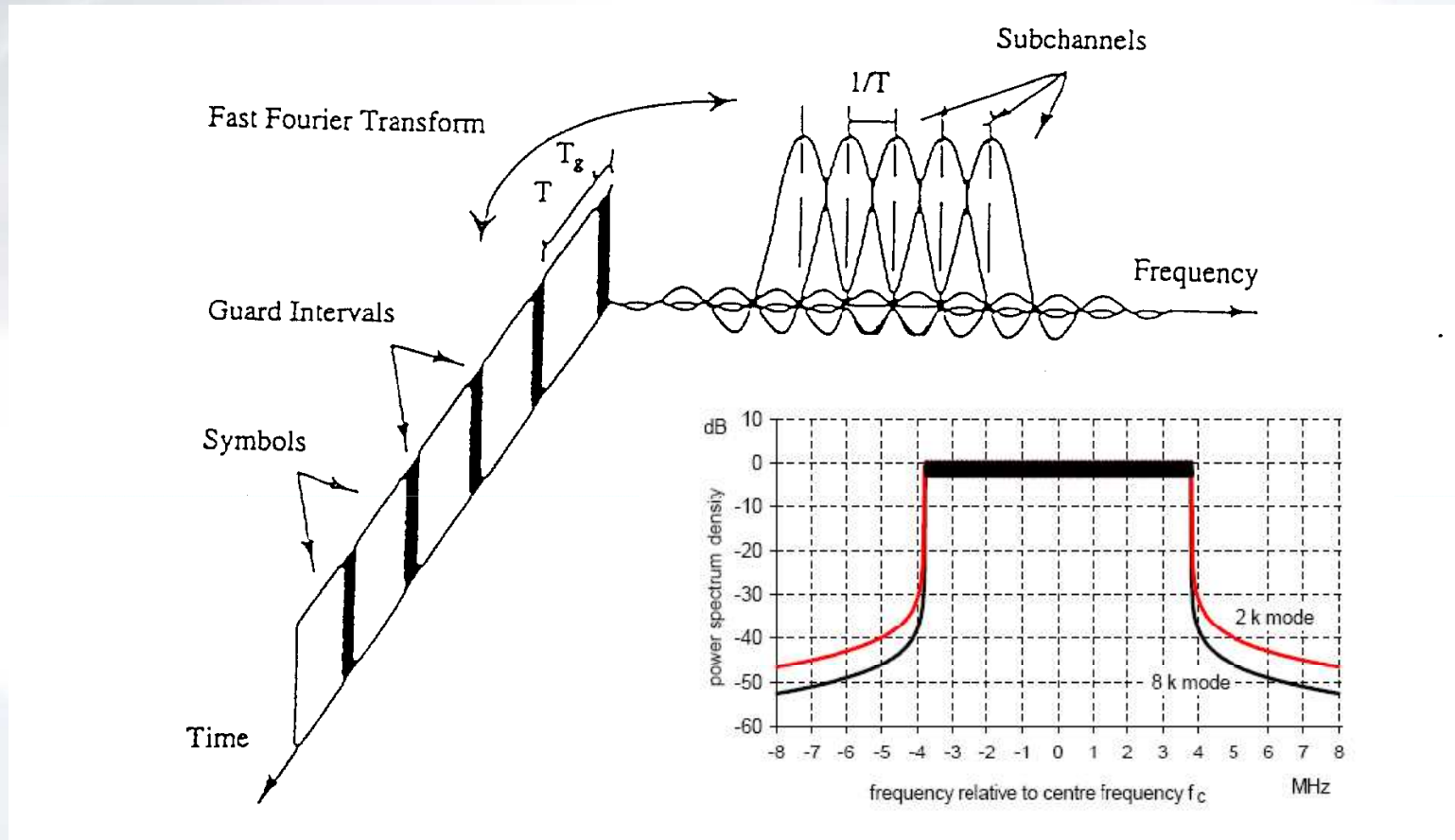

- You may want to visit, e.g., BBC web for COFDM tutorials:

<http://www.bbc.co.uk/rd/pubs/papers/index-digitalbroadcasting-comp.shtml>

- Also <http://www.dvb.org/> or <http://www.dvb.org/index.php?id=278>

DVB-T transmitter

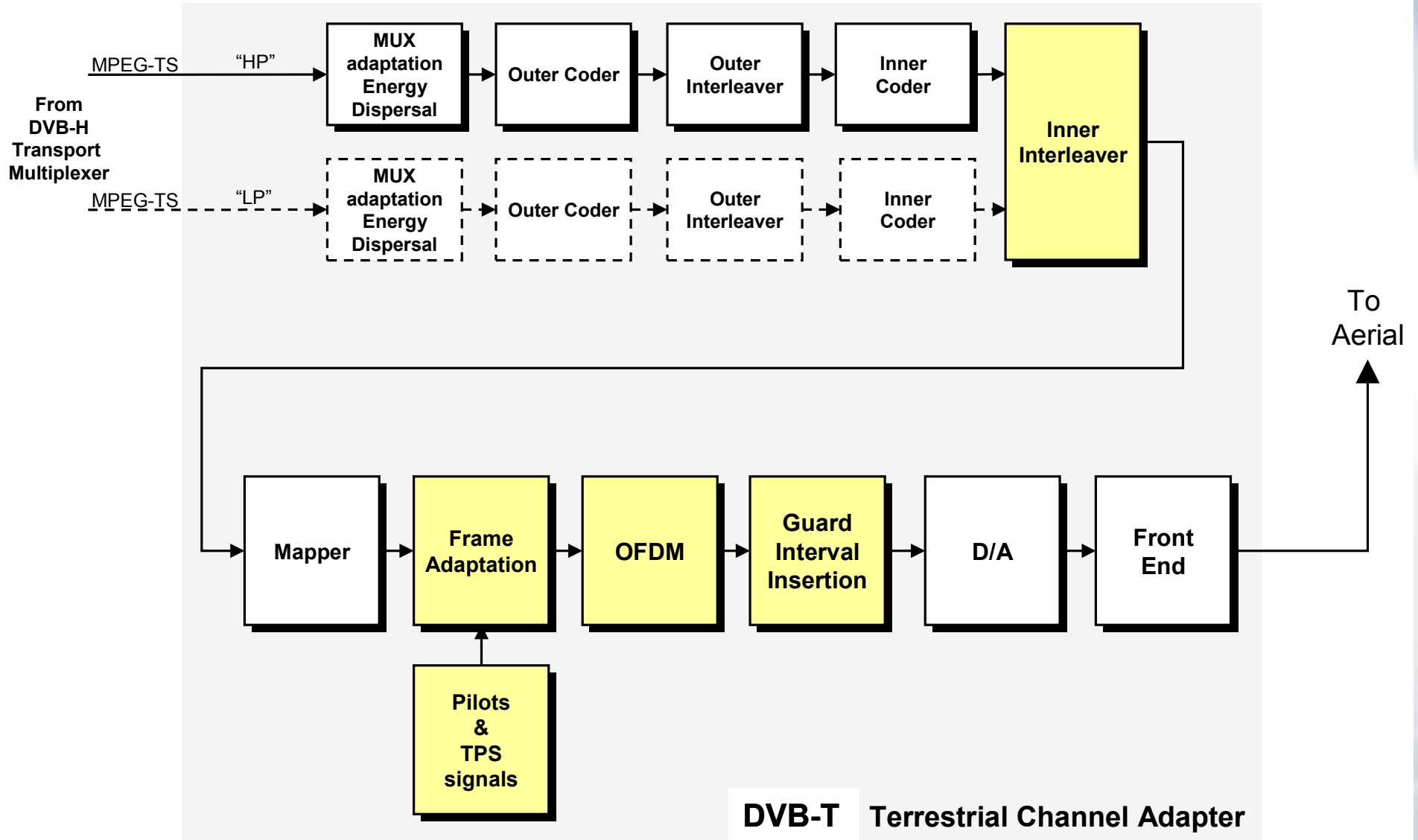

Pilot structure

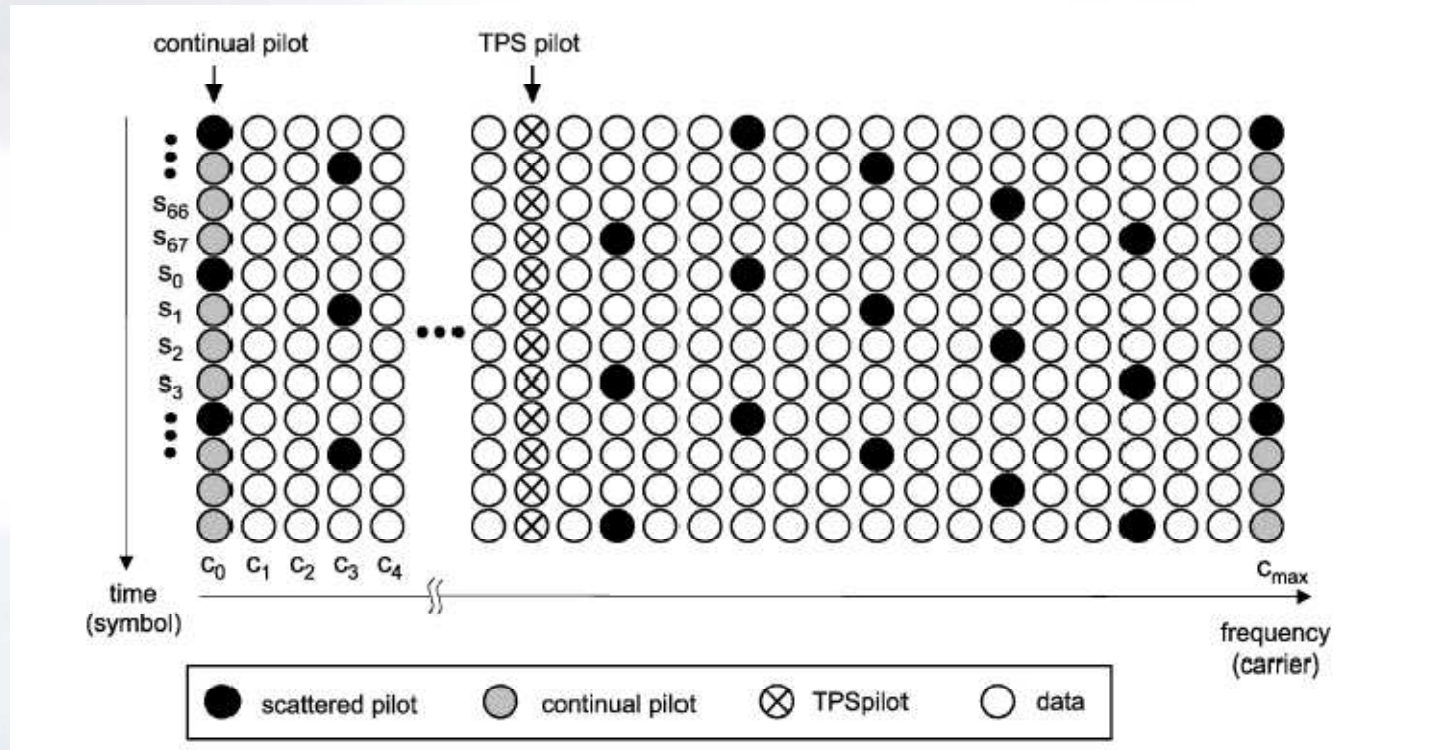

COFDM Channel Decoder

- Critical points:
 - Channel estimation / correction

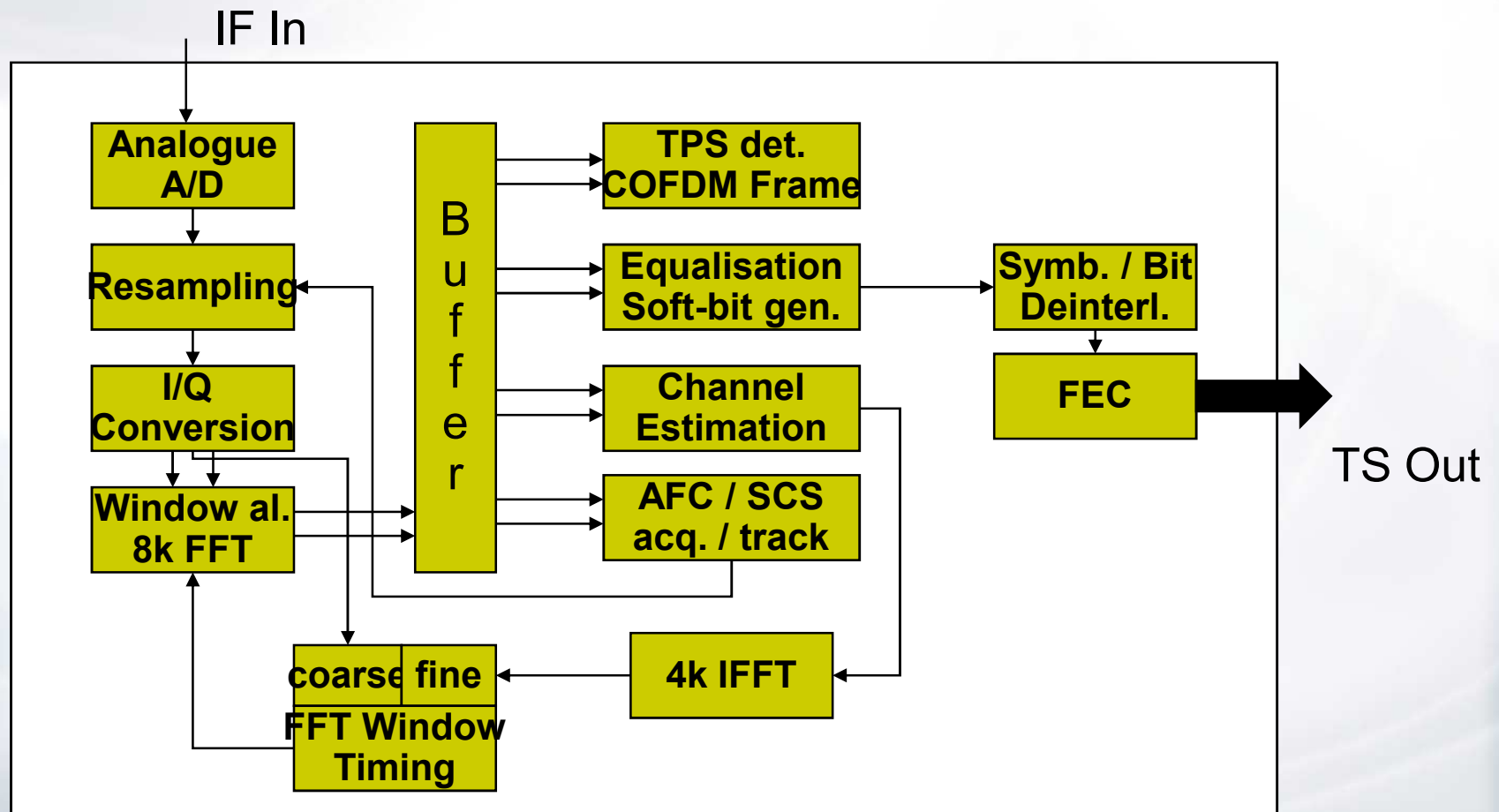

Features of DVB-T

- FFT sizes 2k and 8k
- Convolutional code rates $\frac{1}{2}$, $\frac{2}{3}$, $\frac{3}{4}$, $\frac{5}{6}$, $\frac{7}{8}$
- Reed-Solomon code (255, 239) ($t=8$)
- Modulations 4QAM, 16QAM, 64 QAM
- Four guard intervals $\frac{1}{32}$, $\frac{1}{16}$, $\frac{1}{8}$, $\frac{1}{4}$
- Supports 6,7 and 8 MHz channels
- Intended for VHF and UHF BC bands

- By selecting various parameter combinations one can support networks from high mobility (car reception) to large (nationwide) SFNs

- SFN = single frequency network

An aerial photograph of a winter landscape. The ground is covered in a thick layer of snow. In the foreground, a large, dark evergreen tree stands prominently. The middle ground shows a dense forest of smaller trees, also partially covered in snow. In the background, there are rolling hills and a body of water, possibly a lake or a wide river, under a clear, bright sky. The overall scene is serene and cold.

Why a new standard?

DVB-H

Why & how?

Why a new standard?

- **Broadcast** is the way to get cost down (cf. cellular systems, point-to-point)
- **DVB-T** is existing and known to have good mobile performance
- The **displays on handheld devices smaller** than on fixed reception
 - MPEG2 is probably too heavy, something else could be used
- DVB-T based IP-data broadcasting (IPDC) could be the solution

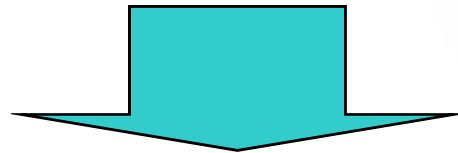

BUT...

...3 MAIN PROBLEMS REMAIN

- **1. Power consumption**
- **2. Performance in cellular environment**
 - - C/N in mobile channel
 - - Doppler in mobile channel
 - - Impulse interference
- **3. Network design flexibility for mobile**
 - - Single antenna mobile reception in medium to large SFN

AND DVB-H SHOULD BE BASED ON DVB-T FOR EASY CO-EXISTENCE

Solution: DVB-H based on DVB-T

Making TV mobile

MPEG-2 over DVB-T

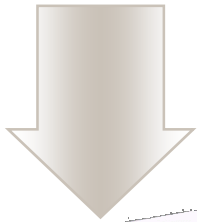

4-5 Mbps/program

3 - 5 TV channels
on big screen

Indoor
reception

Power
saving

Optimal use
of capacity

IP Datacast over DVB-H
(MPEG-4)

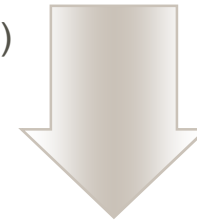

200 - 500 kbps/program

10 - 55 channels
on small screen



Nokia Research Center

NOKIA

Company Confidential

Solution: DVB-H System

(When Sharing the Multiplex with MPEG-2)

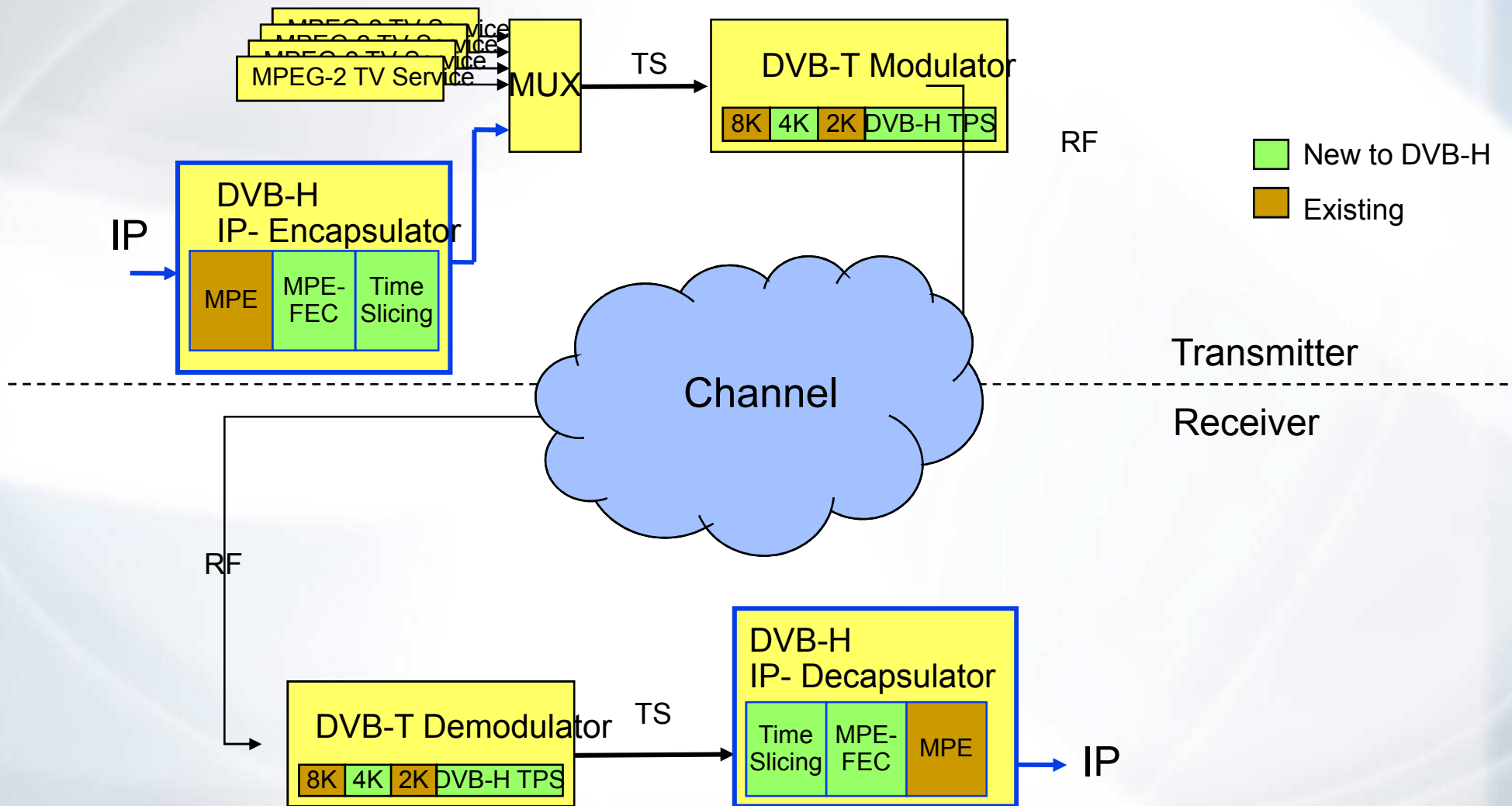

Solution elements

- **Based on DVB-T**,
 - can share multiplex with DVB-T services (backwards compatible)
 - can share frequency band with DVB-T (spectrally compatible)
- **IP-based solution**, Multi Protocol Encapsulation (MPE) used over DVB-T
- **New 1: Time Slicing** for power saving
- **New 2: MPE-FEC (with virtual time-interleaving)** for mobile performance and tolerance to impulse noise
- **New 3: features to DVB-T PHY**
 - **Optional 4K mode** and **4K symbol interleaver**
 - **Optional in-depth interleaver (= short time-interleaving)** for 2K and 4K
 - **5 MHz channels** for non-broadcasting bands
 - + something else...

Time Slicing 1

- In normal DVB-T MPEG-2 and data transmissions the transport streams from the services are multiplexed together with high frequency on the TS-packet level.
- This means that the services are transmitted practically in parallel.

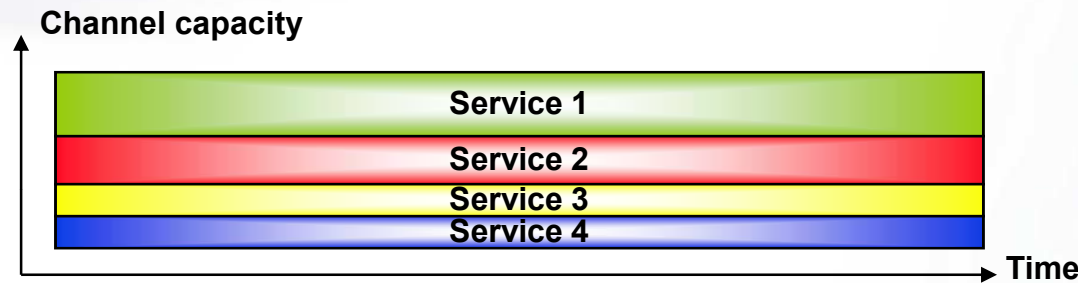

- For a DVB-T receiver it is impossible to receive only the wanted TS-packets due to the high multiplexing rate. All data must be received -> high power consumption.

Time Slicing 2

- In time slicing IP-services within a MPE data service are organised:
 - One service will use the full DVB-H data capacity for a while, say 200 ms.
 - After that comes the next service and so on...
 - After longer period, say 2-4s, the first service is again in the air
 - There might be some 20-50 H –services depending on MUX and service properties

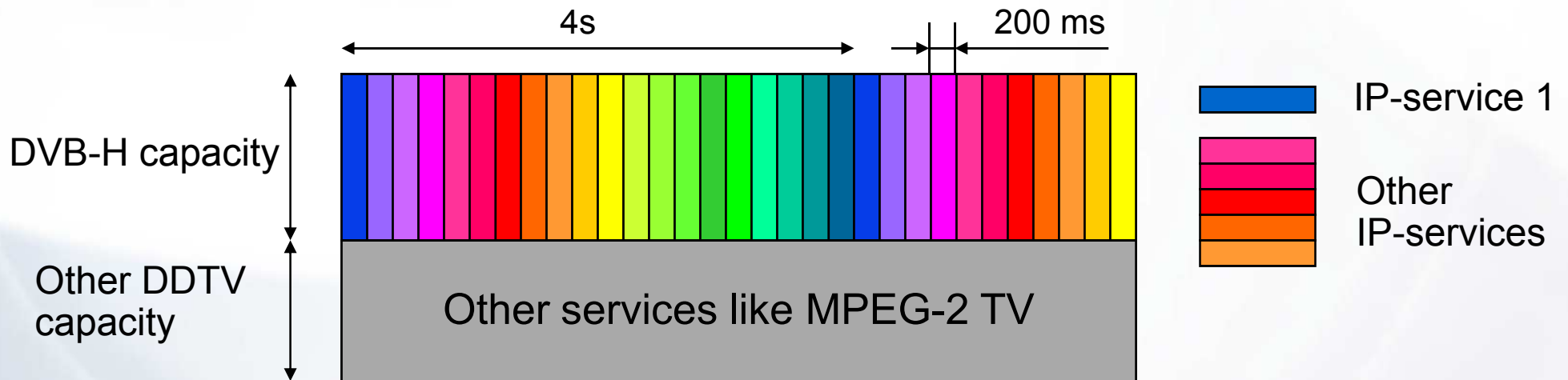

- The DVB-H service is just another “MPE-data pipe” for the DVB-system and can be freely multiplexed with other transport streams.



Best invention since sliced bread?



At least we have time slicing!

MPE-FEC

- IP-Data is filled in vertical direction
- RS-Code words are calculated in horizontal direction
- Data is transmitted in vertical direction
- The number of rows K selectable, K max 1024
- The code may be punctured or shortened => selectable robustness

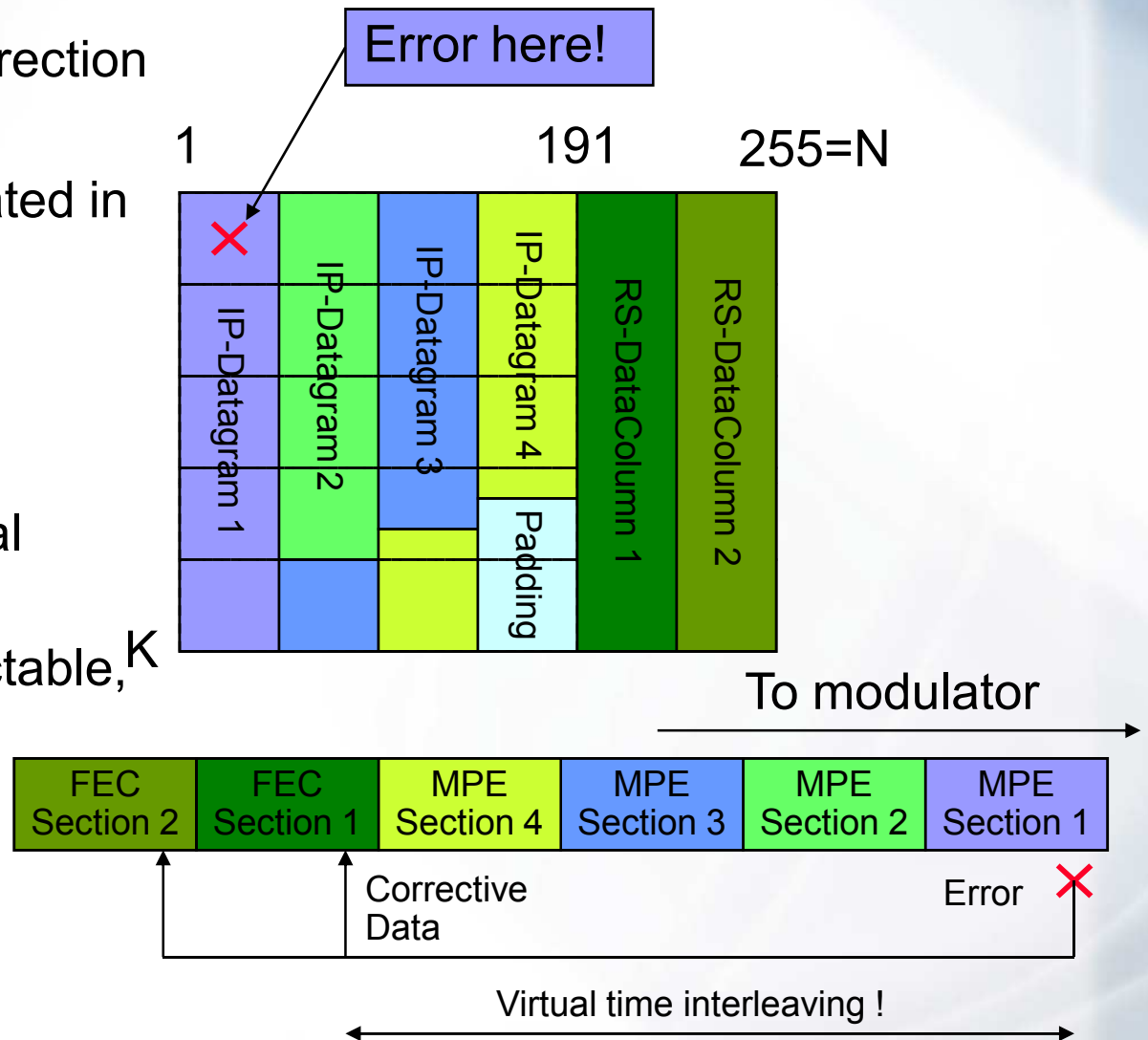

Performance of DVB-H

- Virtual interleaving provided by FEC gives a real improvement to tolerance to Doppler by 50% and more.
- MPE-FEC gives several dB improvement in tolerance to impulse interference
- General improvement in tolerance to noise.

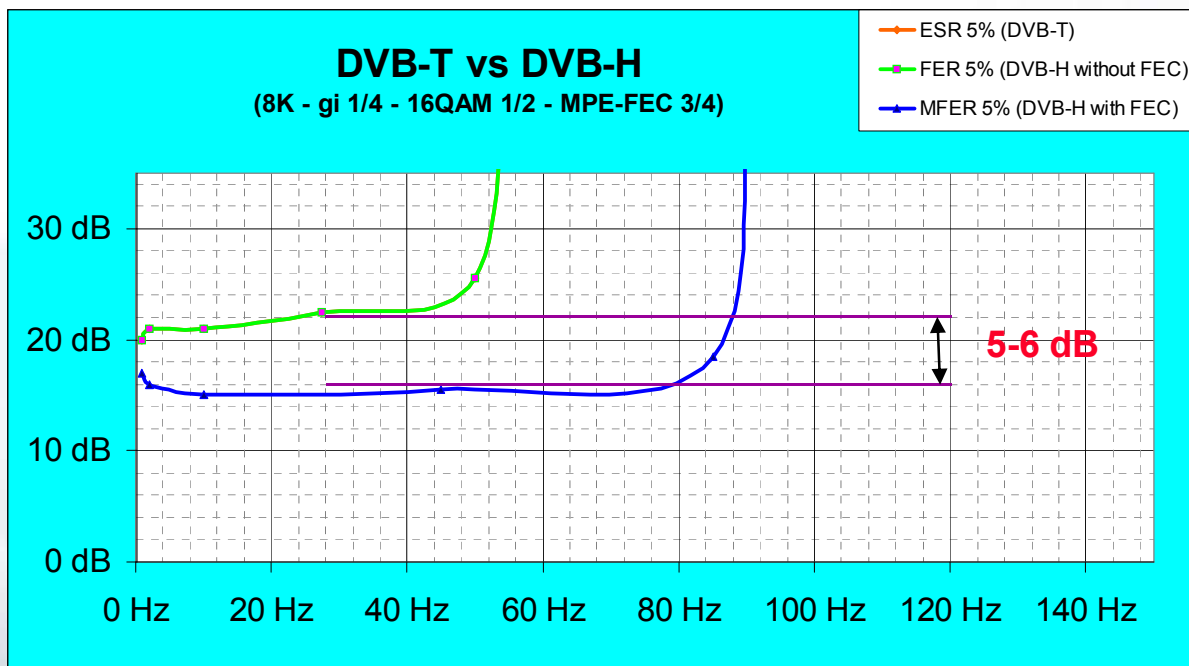

An aerial photograph of a winter landscape. The ground is covered in a thick layer of snow, with patches of dark evergreen trees scattered throughout. In the foreground on the right, a large, detailed evergreen tree stands prominently. The background shows a vast, flat expanse of snow and trees stretching to the horizon under a pale, overcast sky.

Why a new standard?

DVB-T2

Why & how?

Motivation & background

- HDTV is a new service that is coming – already via satellite
 - More capacity needed in terrestrial network
- Technology progress in semiconductors
 - More complexity can be allowed for receiver
- Technology progress in theory & algorithms
 - MISO , MIMO
 - Coding
 - Etc
- DVB had developed second generation DVB-S2 standard with extreme efficiency
 - Wish to repeat the same in terrestrial
- **Capacity increase, robustness and flexibility** were the main drivers

T2 work

- Starting point for T2 work was to take as much as reasonable from existing DVB-T
 - OFDM with guard intervals
 - QAM modulated carriers
 - ...
- But many things were changed
 - TDM structure with synch symbols
 - Possibility of time slicing
 - Service specific robustness
 - LDPC coding
 - Extended modulation
 - => 256QAM
 - Rotated constellations
 - Interleaving
 - etc

Closer Summary of Techniques (1)

- S2 **LDPC** (Rates: $\frac{1}{2}$, $\frac{3}{5}$, $\frac{2}{3}$, $\frac{3}{4}$, $\frac{4}{5}$, $\frac{5}{6}$)
- Compatible S2 system layer (Baseband Frames)
- Classical GI-OFDM
 - FFT sizes: **1K**, 2K, 4K, 8K, **16K**, **32K**
 - GI sizes: **1/128**, 1/32, 1/16, **19/256**, 1/8, **19/128**, $\frac{1}{4}$
 - Bandwidths **1.7**, 5, 6, 7, 8, **10** MHz
- **8** Scattered Pilot patterns
- Time interleaving at physical layer to improve impulse noise robustness
- Time slicing at physical layer
 - Different PLPs can have different levels of robustness
 - Enables power saving
- Sub-slicing within frame
 - Increases time diversity/interleaving depth without increasing de-interleaver memory

Closer Summary of Techniques (2)

- P1 symbol for frame sync. and for rapid T2 signal detection
- P2 symbol carrying frame construction data and PSI/SI information
- Three main levels of interleaving
 - Bit interleaving, Time interleaving and Frequency interleaving
- Rotated constellations
- MISO capability (Alamouti-based transmit diversity)
- Peak-to-average-power reduction via tone reservation and constellation distortion
- Future Expansion Frames
- Signalling and compatibility with future implementations of Time Frequency Slicing

Key features: BB Frames and LDPC

- Data packaged into BaseBand Frames
- BaseBand Frames protected by the S2 LDPC FEC
 - With an additional small BCH code to mop up any residual errors after LDPC decoding

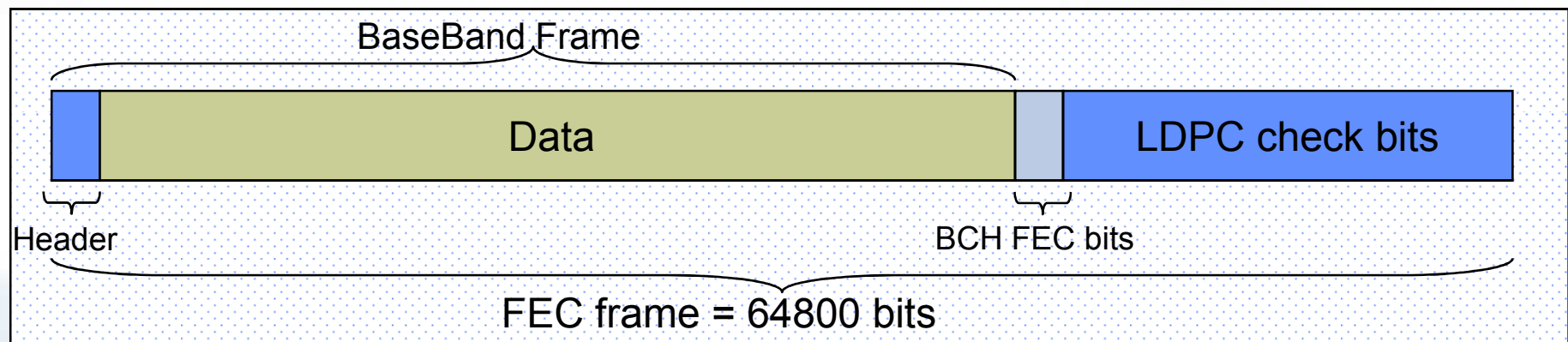

- This FEC frame, of length 64800 bits, is a fundamental unit within T2
 - Code rates: 1/2, 3/5, 2/3, 3/4, 4/5, 5/6
 - A shorter FEC frame of 16200 bits also provided for low data rate services

Key Features: Modulation (1)

- T2 uses conventional Guard-Interval OFDM (GI-OFDM)
 - as in DVB-T

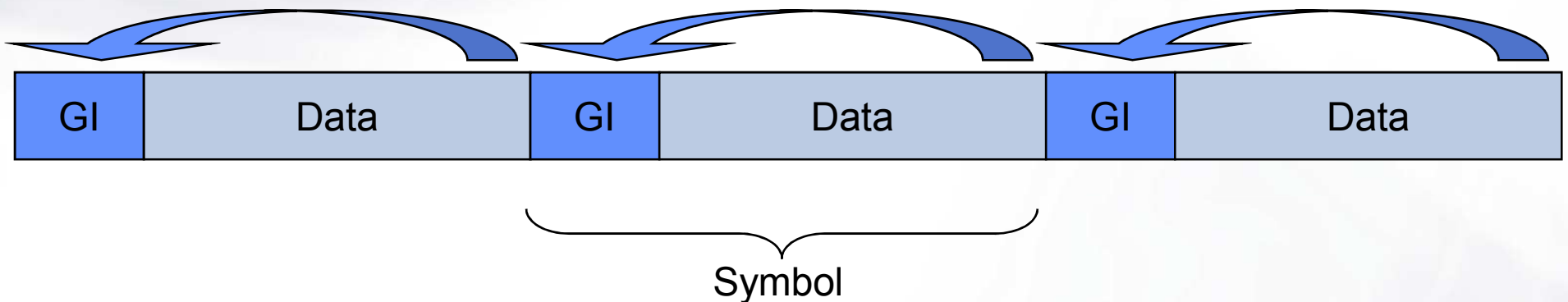

- Each symbol carries data on a large number of separate carriers
 - 1K, 2K, 4K, 8K, 16K, 32K options are available in T2
 - 16K and 32K: to give improved SFN performance
 - 1K for bandwidth and frequency flexibility
 - Increasing the number of carriers increases the symbol period

Key Features: Modulation (2)

- Increasing the symbol period
 - Can reduce guard interval overhead for given size of SFN
 - Can increase SFN capability for a given fractional GI

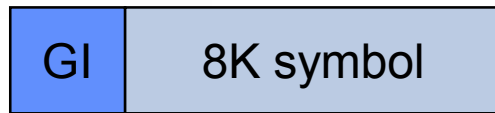

25% overhead

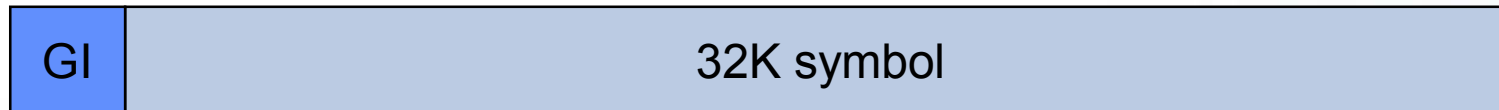

~6% overhead

- T2 extends guard interval range to allow reduced overhead and additional flexibility
 - GIs in T2: $1/128$, $1/32$, $1/16$, $19/256$, $1/8$, $19/128$, $1/4$

Key Features: Modulation (3)

- T2 includes 256 QAM mode
 - Carries 8 bits/ data cell
 - (c.f 6 bits / data cell for 64 QAM)
 - Enables greater capacity, exploiting improved FEC performance of LDPC
 - Studies show that typical tuner phase noise should not be a problem

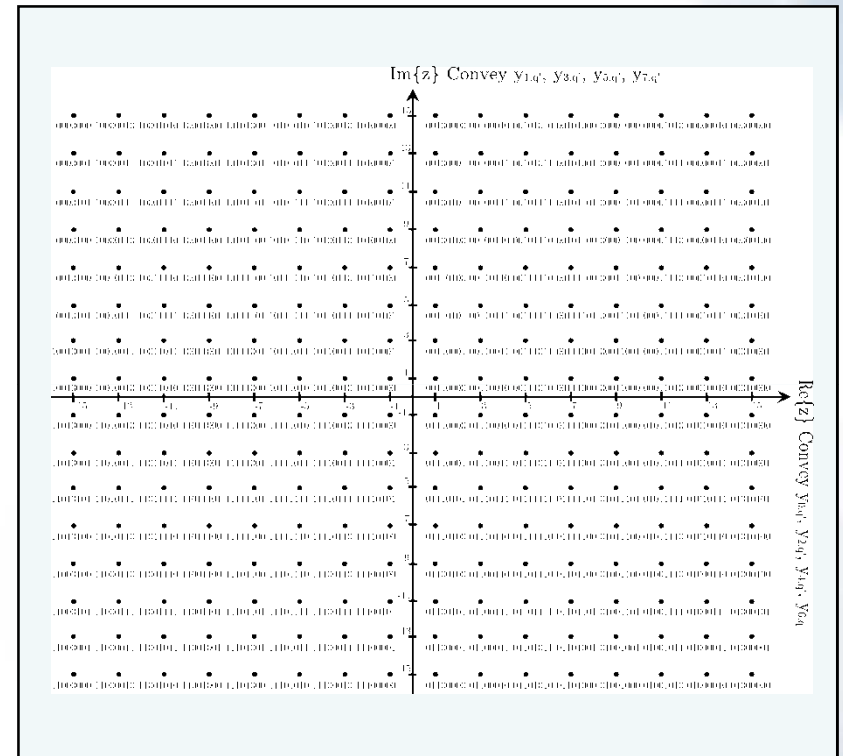

Scattered Pilot Patterns (1)

- Scattered pilots are OFDM cells of known amplitude and phase
 - Receiver uses these to compensate for effects of channel changing in frequency and time.
- In DVB-T, 1 in 12 OFDM cells is a scattered pilot
 - 8% overhead
 - Independent of guard-interval fraction

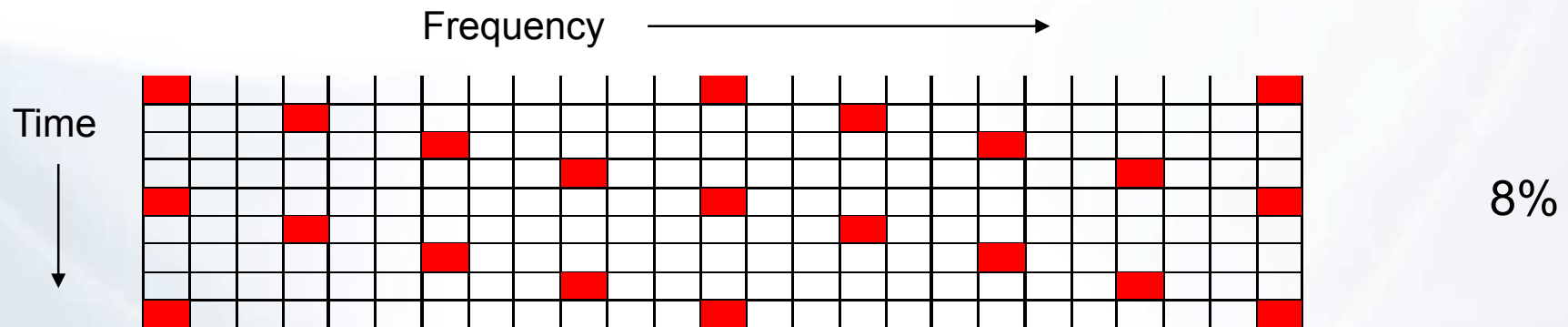

Scattered Pilot Patterns (2)

- T2 has 8 different scattered pilot pattern options
 - Aim: to minimise pilot pattern overhead for a given fractional guard interval; e.g.

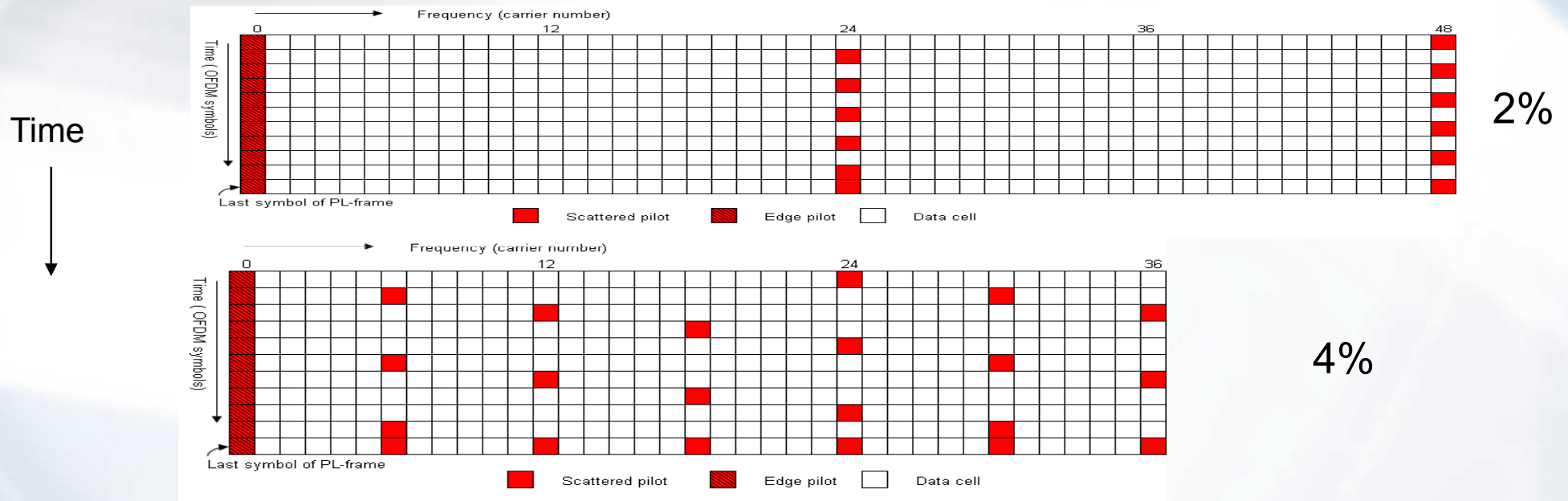

- Pilot cells are boosted by up to 7 dB depending on density
 - Improves signal to noise on channel estimate
- Pilot pattern modulated by pseudo-random sequence
 - Can be used for improved time synchronisation algorithms
- Pilot pattern modified for edge carriers and for last symbol of frame

Key features: Service Specific Robustness

- Each service can be given its own modulation mode (e.g. 256QAM, 16 QAM) and FEC coding rate (e.g. rate 3/5, rate 3/4)
 - Different applications: roof-top reception/portables

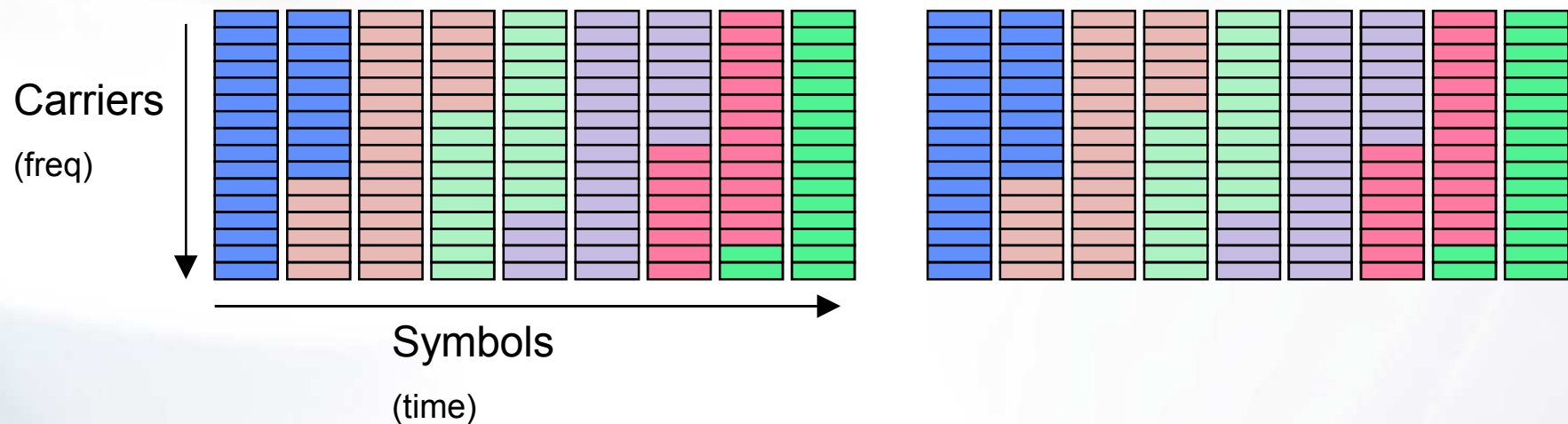

- Each service is given a slice of data cells within a frame
 - Each slice is part of a *Physical Layer Pipe* for that service
 - Also enables power saving in the receiver
 - Slices can be sub-divided into sub-slices within frame in order to give more time diversity

Key features: Frame Structure

- Start of frame is signalled by a short P1 symbol
 - Based on **1K OFDM** symbol with frequency shifted repeats at front and rear of symbol

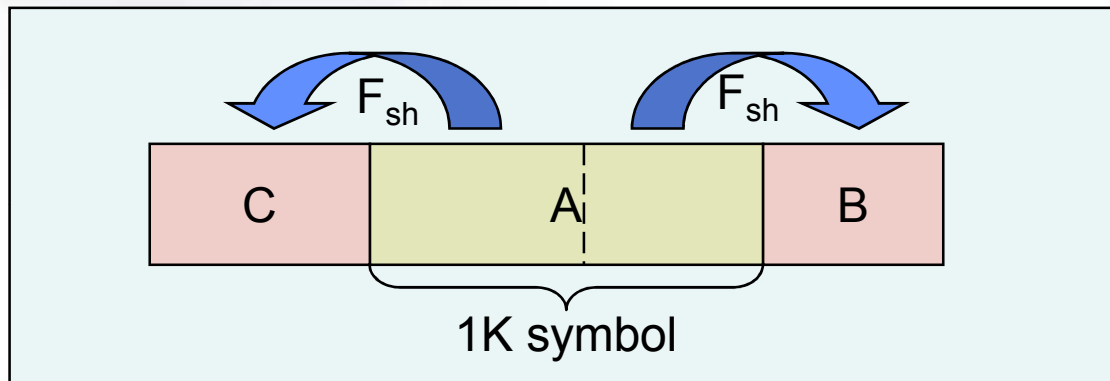

- Only a sparse proportion of 1K carriers occupied
 - Carrying carefully chosen data patterns
- Lengths of segments carefully chosen

- This format of P1 symbol provides
 - Simple and robust mechanism for rapid detection of T2 signal
 - Fast frequency lock mechanism
 - 7 bits of signalling (e.g. for FFT size in main frame)

Frame Structure (2)

- Structure of frame must be signalled at beginning of frame
 - Start address and length of individual PLPs
 - This data is carried in P2 symbols which follow P1 symbol
 - Number of P2 symbols depends on FFT size
 - Frame structure data must be carried robustly
 - Use **strong FEC and modulation modes** within P2
 - Channel equalisation must be rapid and robust
 - Use a **greater density of scattered pilots**

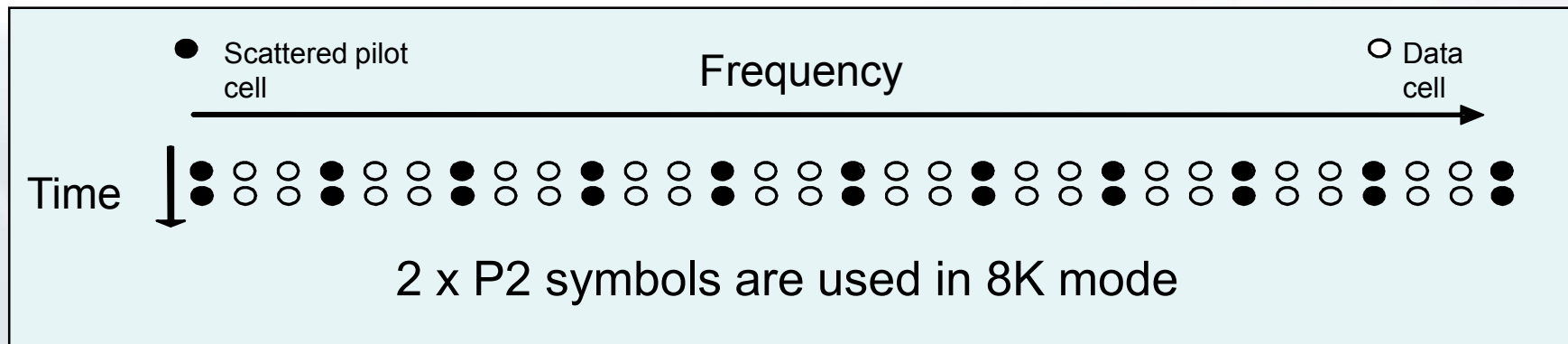

Frame Structure (3)

- Typical frame duration: 150 -250 ms
 - P1 & P2 overhead typically less than 1%

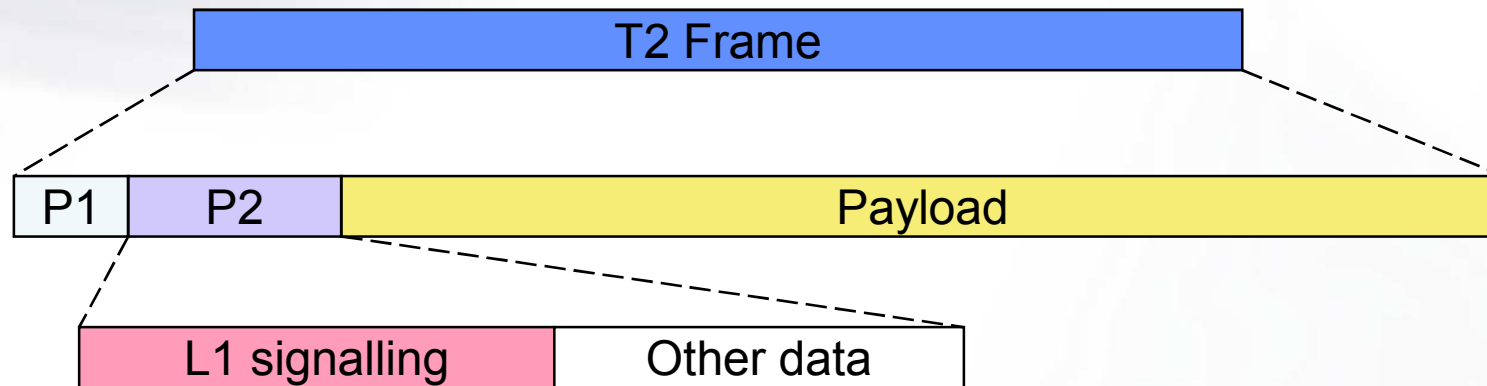

- L1 signalling carries frame structure data
 - L1 data must be carried more robustly than payload data
 - L1 data split into 2 parts: L1-pre (very robust); L1-post (quite robust)
- Other data carried in P2 can include common PSI/SI data for services carried in payload

Frame Structure (4)

- Typical use – single PLP
 - Complete transport stream is contained within single PLP
 - Including all PSI/SI
- Typical use – multiple PLP
 - Each PLP carries a transport stream
 - Frame structure for all PLPs is contained in L1 data - which is
 - carried in P2 symbols at beginning of frame
 - And normally carried 'in-band' with each PLP – for that PLP (to reduce need to decode P2 symbols)

Interleaving

- LDPC works well only for randomly distributed bit errors
 - Must avoid regular patterns of errors and bursts of errors
 - Must randomise mapping of bits from FEC block into constellation points
- T2 uses three main **interleavers – applied per PLP**
 - **Bit Interleaving within an FEC block**
 - Randomises errors from single errored data cells
 - Based on a row/column block interleaver - with a 'twist'
 - **Time Interleaver**
 - Disperses data cells from FEC blocks of a given service throughout slice (/subslices) for that service
 - **Frequency Interleaving**
 - Causes randomisation of possibly-damaged adjacent data cells within an OFDM symbol
 - Provides robustness against a frequency-selective channel
 - T2 uses twin interleavers (based on DVB-T interleaver)

Rotated Constellations (1)

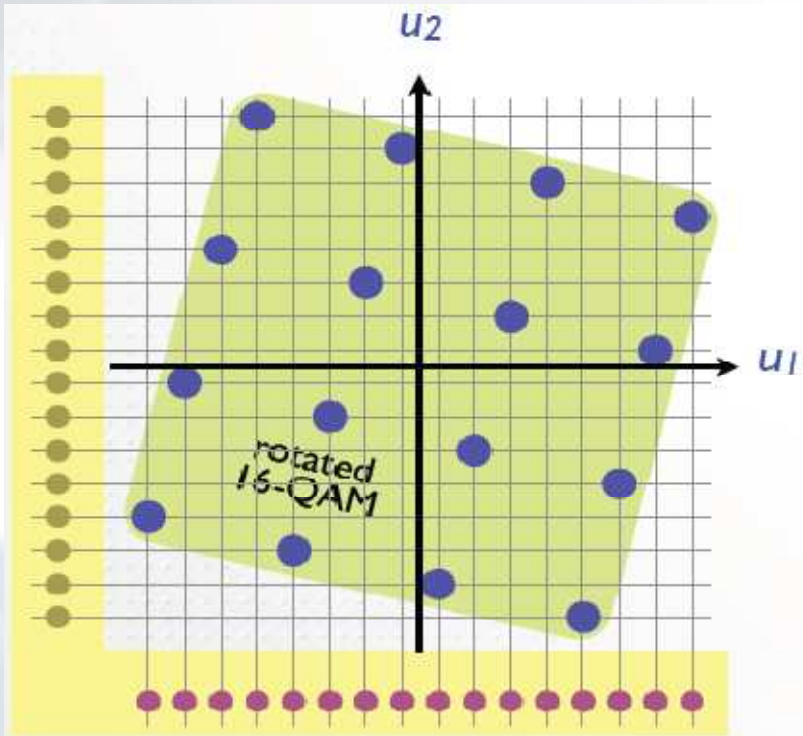

- Map data onto a normal QAM (x,y)
- Rotate constellation (axes now (u_1,u_2))
- Ensure u_1 and u_2 travel in different cells
 - So that they fade independently
 - Gather together in receiver

- Each of u_1,u_2 carries all of the info of original x,y
 - So can decode (less ruggedly) if one is erased completely

Rotated Constellations (2)

Comparison of performance for rotated/non-rotated constellations
(code rate=4/5; channel = Rayleigh + 15% erasures)

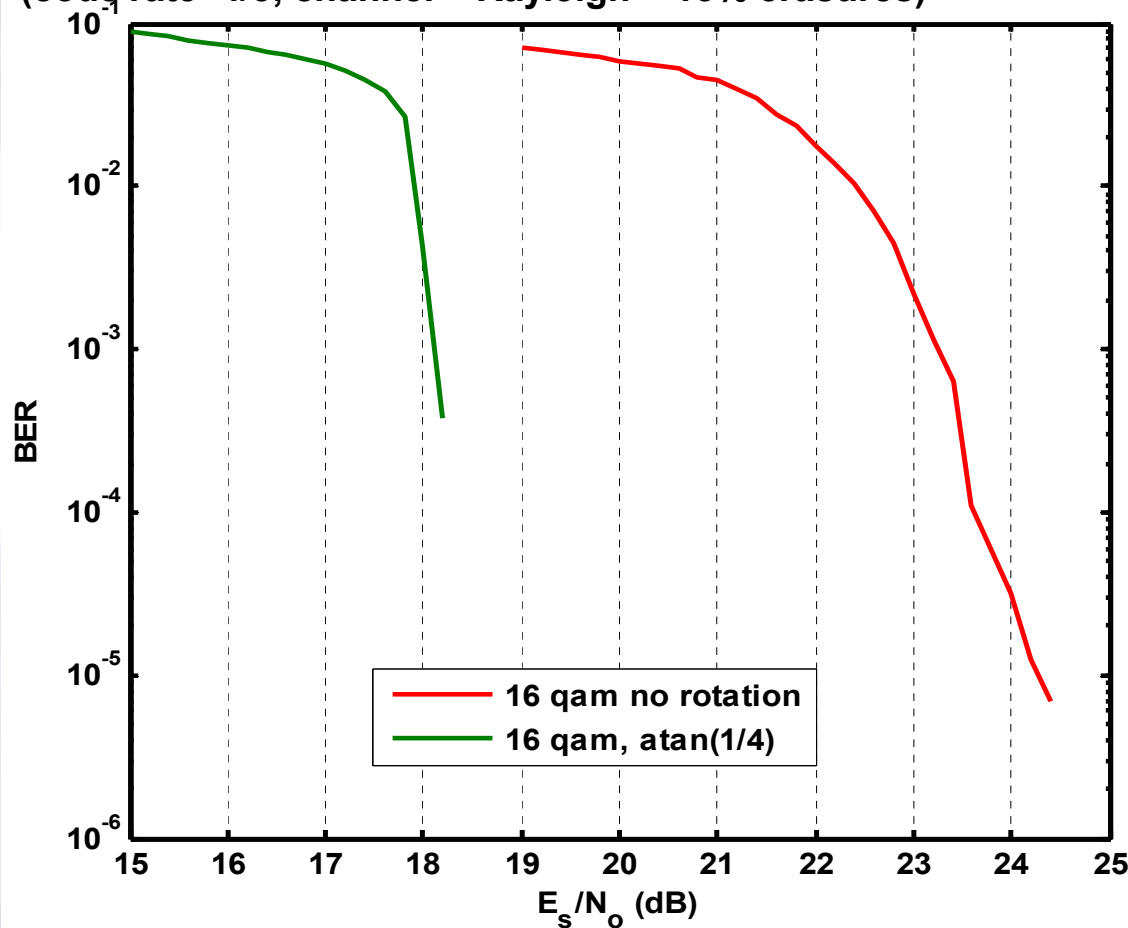

- Rotated constellations provide significantly improved robustness against loss of data cells
 - Can achieve gains of up to 5 dB on difficult channels
 - e.g. 15% cell loss channel
 - Can translate into increased bit rate by choosing less robust FEC with lower overhead

Transmit Diversity (1)

- T2 includes Alamouti coding mode for simple SFNs
 - While Tx1 transmits pair of data cells S_0, S_1 , Tx2 transmits $-S_1^*, S_0^*$
 - Also involves modification of pilot patterns to measure $h1$ and $h2$
 - This prevents possibility of 'flat fading' at receiver

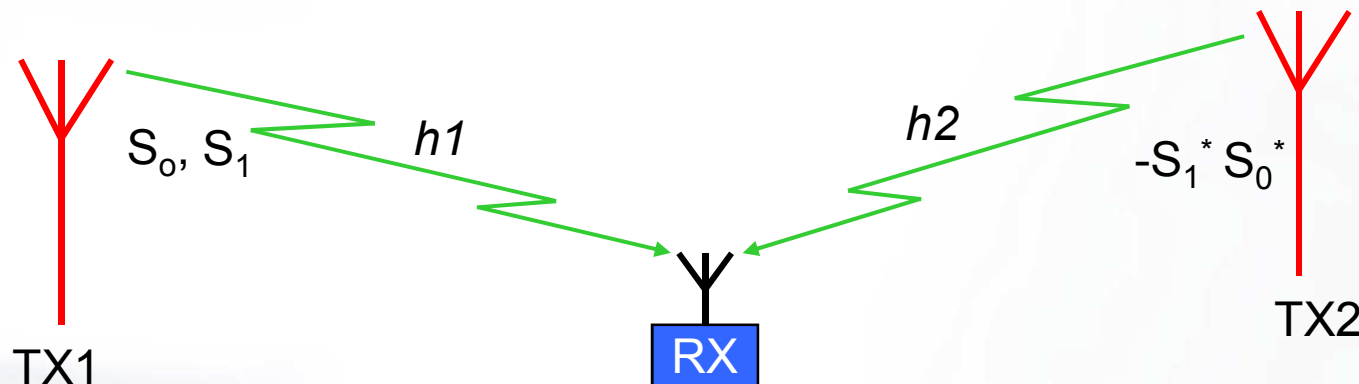

- Initial planning studies predict 30% increase in coverage area for simple SFNs

Transmit Diversity (2)

- Scattered pilot patterns are modified (for second transmitter) to enable measurement of channels h1 and h2; e.g. -

Transmitter 1

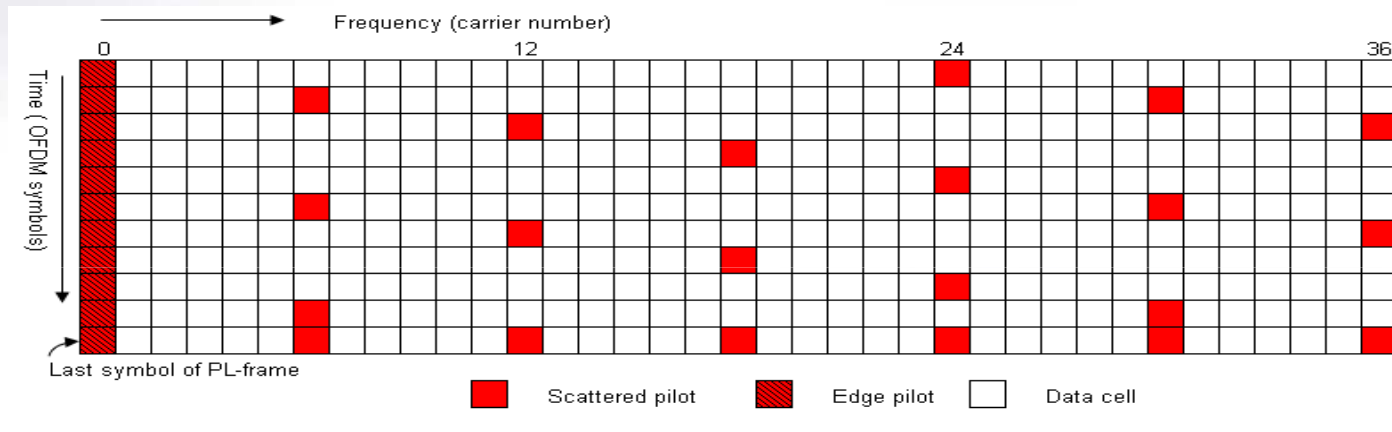

Transmitter 2

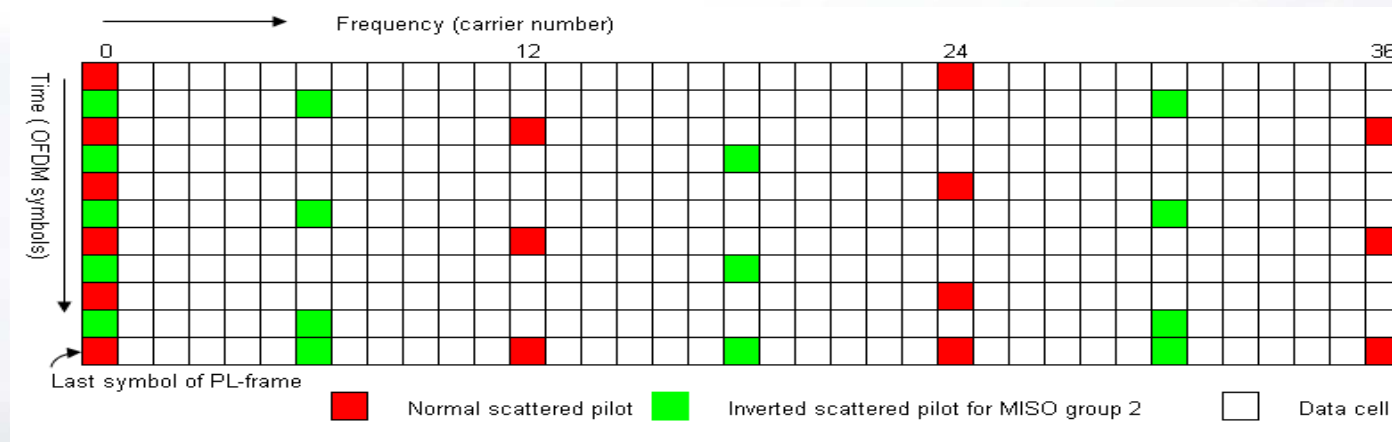

Additional Features

- Future Extension Frames (FEFs)
 - Provide a mechanism for future compatible enhancements – e.g. MIMO
 - Only requirement is for FEF to start with P1 symbol

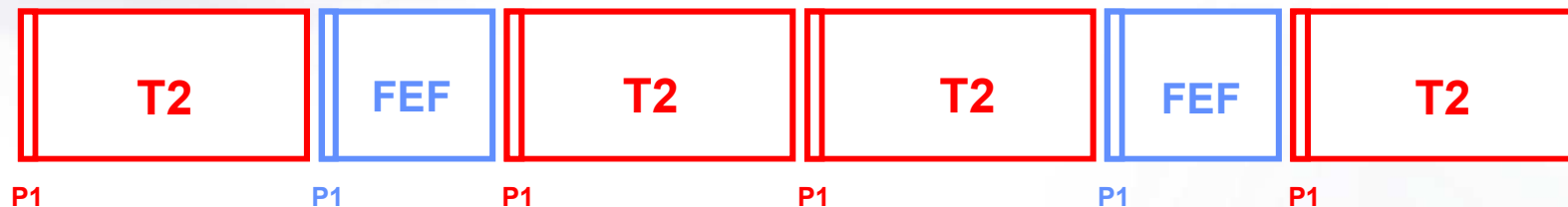

- Time Frequency Slicing
 - Multiplex of signals is spread across several linked frequencies
 - Can give significant Stat Mux gain (20%) and frequency planning gain (5dB)
 - T2 signalling and system is compatible with Time Frequency Slicing system provided receivers have 2 tuners

Modulation and Coding performance

- Capacity limits for simple Gaussian noise channel
 - With LDPC can get close to theoretical limit
- Typically 30% gain in capacity compared with DVB-T codes.

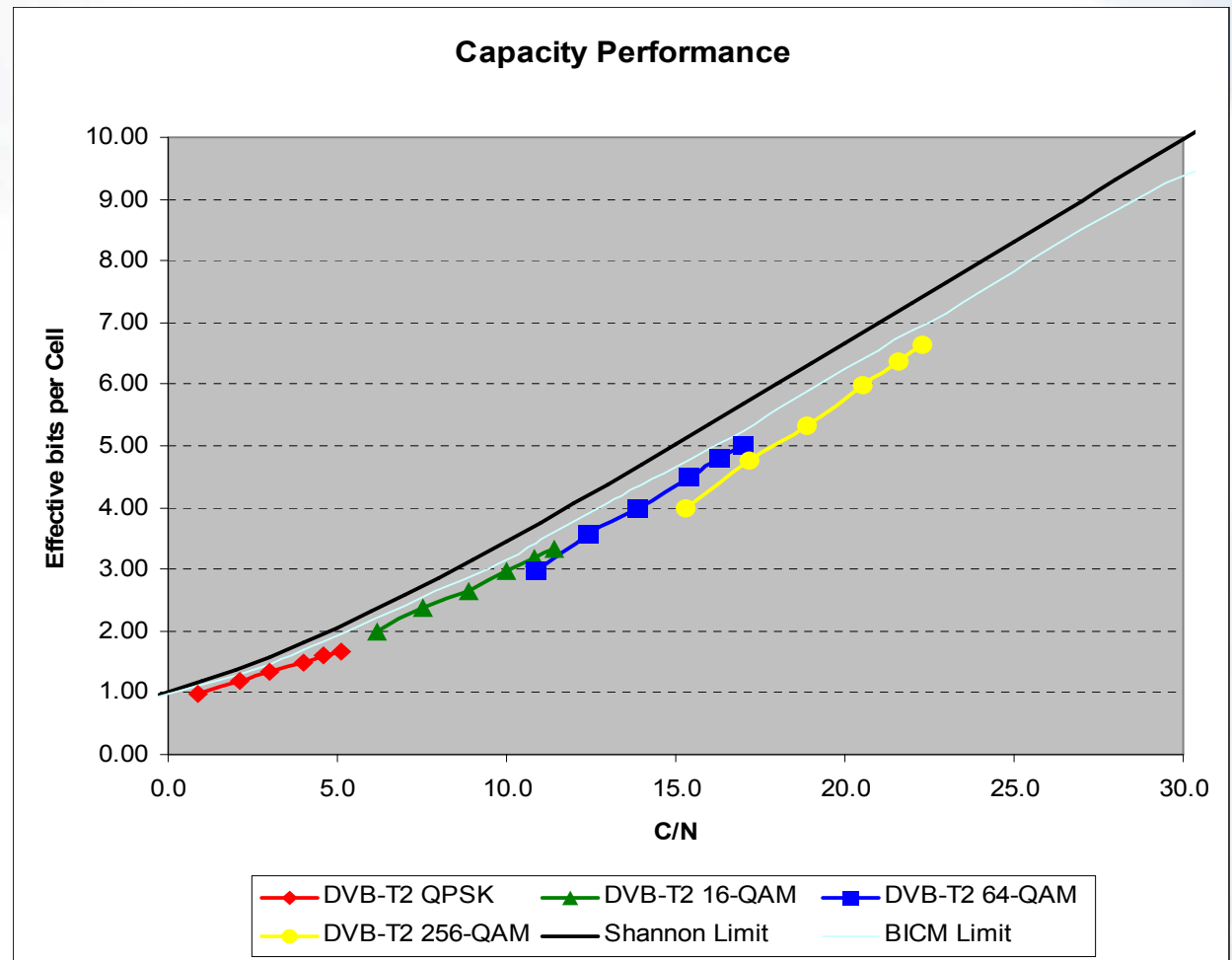

An aerial photograph of a winter landscape. The ground is covered in a thick layer of snow, with patches of dark evergreen trees scattered throughout. In the foreground on the right, a single, tall evergreen tree stands prominently, its branches heavily laden with snow. The background shows a vast, flat expanse of snow-covered land under a pale, overcast sky.

Why **STILL** a new standard?

**Future NGH
Why & how?**

Motivation & background

- Technology progress
 - Various new things possible
- Business environment changes
 - New standards competing with DVB-H or otherwise changing the situation
 - LTE, T2 etc
- Room for improvement
 - Robustness and indoor reception are the main points
 - There exists reasonable and realistic means to address this within a couple years time frame

DVB study mission on NGH

- A study mission (NGH- next generation handheld) to probe these issues was launched in DVB June 2007
- SM Conclusions Spring 2008:
 - The new standard should address **all relevant market segments** (terrestrial, terrestrial-satellite hybrid) in order to avoid market fragmentation.
 - If significant capacity increase is needed, feasibility and available performance using **multiantenna techniques (MIMO) in handheld terminals** should be carefully assessed
 - The new standard NGH, among other things listed above, should be capable of using multiple bands of spectrum and have flexible spectrum use.

2x2 MIMO promise vs. Alamouti 2x2

SIDSA, study mission have computed this capacity for a perfect MIMO 2x2 system, and for the Alamouti system used in diversity 2, which is a particular implementation of 2x2 MIMO.

	Capacity for Alamouti 2x2 (bit/cell)	Capacity for optimal MIMO 2x2 (bit/cell)
SNR = 0 dB	1.44	1.59 (+10.1 %)
SNR = 4 dB	2.36	2.73 (+15.6 %)
SNR = 8 dB	3.46	4.22 (+22.1 %)
SNR = 12 dB	4.68	5.04 (+29.2 %)
SNR = 16 dB	5.96	8.12 (+36.1 %)

Note: very preliminary, overview result

The result depends strongly on the channel model and actual implementation

“Real” MIMO seems to provide substantial benefit

But is there REAL need?

- DVB set up **CM group CM-NGH** in 2008 to define commercial requirements
- The key findings
 - Technology has progressed and significant improvement in performance is available
 - **Robustness and indoor reception** are the main points
 - The business environment changes due to T2, LTE etc
- CM listed several general requirements (24.6.2009) like
 - NGH must be sufficiently **flexible** to deliver content types that match the varying amounts of attention a user might want to devote: e.g. radio, radio with slideshow, high quality (SD) TV
 - Must **integrate with 'back channel' technologies** to offer a truly immersive, two-way experience
 - Must be able to offer extended viewing sessions therefore extended **battery life** is important
 - Must offer fast access to services therefore **fast start up and channel switching** are important
 - Should be able to act as a 'second screen' by offering content that complements and synchronises with content on DVB-T(2) and other platforms
 - Should be possible to offer **location specific content**

Technology comments

- **Overhead reduction**

- Changing the base code (like in DVB-T2) to LDPC (or equivalent), significant reduction is available
- IP overhead can be reduced (e.g. header compression)

- **Performance increase**

- Changing **coding** ; RS => LDPC (like in T2)
- Additional **low code rates** for robustness (e.g. rate $\frac{1}{4}$...)
- **Longer interleaving**
- Two tuner approach
 - Use 2x2 or (distributed) 4x2 **MIMO** (probably in crosspolarized form)
 - Use diversity (polarization or spatial?)
 - Or even TFS (time-frequency slicing)?!!
- **Rotated constellations** (from T2)

Technology comments 2

- **New bands**

- MIMO probably not feasible in VHF, UHF still unclear
- Above 1 GHz MIMO is feasible
 - However: No feedback info about the channel to the Tx is available => MIMO is not as efficient as in p-t-p connections
- Satellite bands: Satellite option requires very long interleavers (ca 10 s!) => large memory needed

Challenges for NGH system

- How to deal with MIMO & diversity question?
 - Obligatory for UHF and above or optional (e.g. in UHF)?
 - Receiver complexity and cost issue
- How to deal with long interleaver issue?
 - Zapping time & delay
 - Memory
 - Cost - how to support satellite services without unreasonable burden to all receivers?
- How to share T2 & NGH in one RF channel?
 - Using Future extension frames (FEF) of T2?
- How to handle upper layer issues?
 - TS, IP etc transport
 - Seamless/easy service handover via various bearers

How to simplify – not only adding features??!!

What could it be?

Wild, (educated?) guess

- T2 based system with some additions/modifications
 - More (and less!) coding rates
 - Long time interleaving (at least as option)
 - At least some support for 2x2 and possibly 4x2 MIMO
 - Less overhead
 - Streamlined to allow various service handover
 - Allowing flexible use together with T2 and within T2
 - e.g. using future extension frames

Hope that this does not block anybody to make innovations!

NGH work scheduling (draft)

- CM approval – 24. June 2009
- SB approval – 2 July 2009
- Start of technical work (CfT) – November 2009 (probably)
- Draft Specification – 2H 2010
- Draft IG and other documents – Mid 2011
- Publication of Specification(s) – End 2011/2012

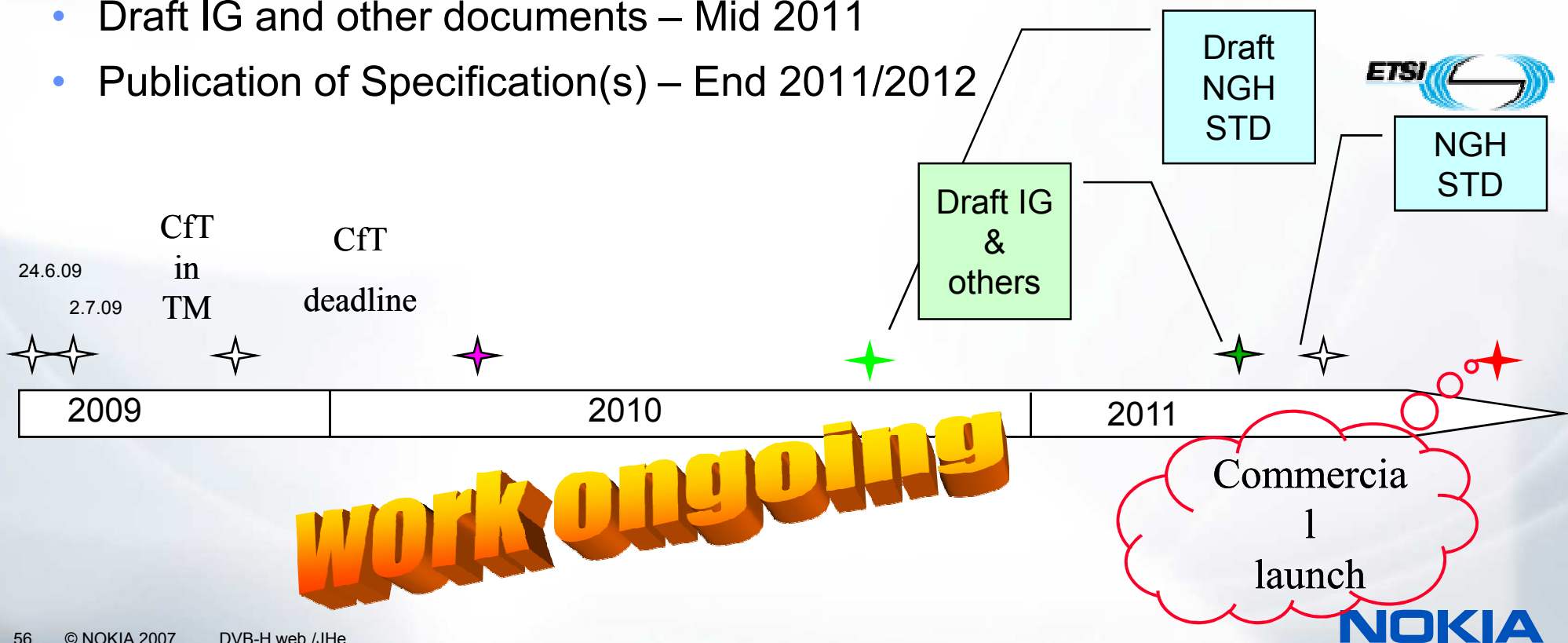

Conclusions

- DVB is a living organization that has been successful in creating broadcast standards over ten years
- DVB-T => DVB-H => DVB-T2 => DVB-NGH form a natural evolution path for fixed and mobile handheld broadcasting
- The future may provide more tightly knitted family of terrestrial broadcasting standards (T2-NGH)
 - Serving all segments – home rooftop reception, portable, mobile (vehicular) and handheld receivers
- The performance is (will be) very close to Shannon limits
 - One cannot significantly improve spectral efficiency after this by defining a new physical layer standard
 - Other improvement might be possible
 - (e.g. areal/temporal etc spectral efficiency)
 - ???

Thank You!

Special thanks for many slides to
several colleagues
from Nokia and DVB community

References

- [1] ETSI EN 302 304 V1.1.1 (2004-11), Digital Video Broadcasting (DVB); Transmission System for Handheld Terminals (DVB-H)
- [2] ETSI EN 301 192 V1.4.1 (2004-11); Digital Video Broadcasting (DVB); DVB specification for data broadcasting
- [3] ETSI EN 300 468 V1.6.1 (2004-11), Digital Video Broadcasting (DVB); Specification for Service Information (SI) in DVB systems
- [4] ETSI EN 300 744 V1.5.1 (2004-11), Digital Video Broadcasting (DVB); Framing structure, channel coding and modulation for digital terrestrial television
- [5] ETSI TS 101 191 V1.4.1 (2004-06), Digital Video Broadcasting (DVB); DVB mega-frame for Single Frequency Network (SFN) synchronization
- [6] ETSI TR 102 401 V1.1.1 (2005-04), Digital Video Broadcasting (DVB); Transmission to Handheld Terminals (DVB-H); Validation Task Force Report VTF
- [7] ETSI TR 102 377 V1.2.1 (2005-11), Digital Video Broadcasting (DVB); DVB-H Implementation Guidelines
- [8] Reimers Ulrich, "DVB- the Family of International Standards for Digital Video Broadcasting, 2nd ed., Springer, 2005, 408 pp.
- [9] Henriksson, Talmola: "Coach potato - meet the standard... DVB-H", IEE Communications Engineer, AugSept 2004, p.28-32.
- [10] Faria, Henriksson, Stare, Talmola: DVB-H: Digital Broadcast Services to Handheld Devices, Proc. IEEE vol 94, no1, pp. 194-209, Jan 2006
- [11] ETSI EN 302 755 V1.1.1 Digital Video Broadcasting (DVB); Frame structure channel coding and modulation for a second generation digital terrestrial television broadcasting system (DVB-T2)

<http://www.dvb-h.org/>

www.nokia.com/mobiletv

Competition & future

- Several competing standards exist
 - Japanese one segment ISDB-T
 - Korean DMB-T
 - Qualcomm MediaFlo
 - Chinese CMMB
 - (MBMS)
- New evolutions emerging
 - DVB-T2
 - US evolution of ATSC
 - Etc

Digital broadcast is strongly & rapidly evolving area

DVB-T encoding block diagram

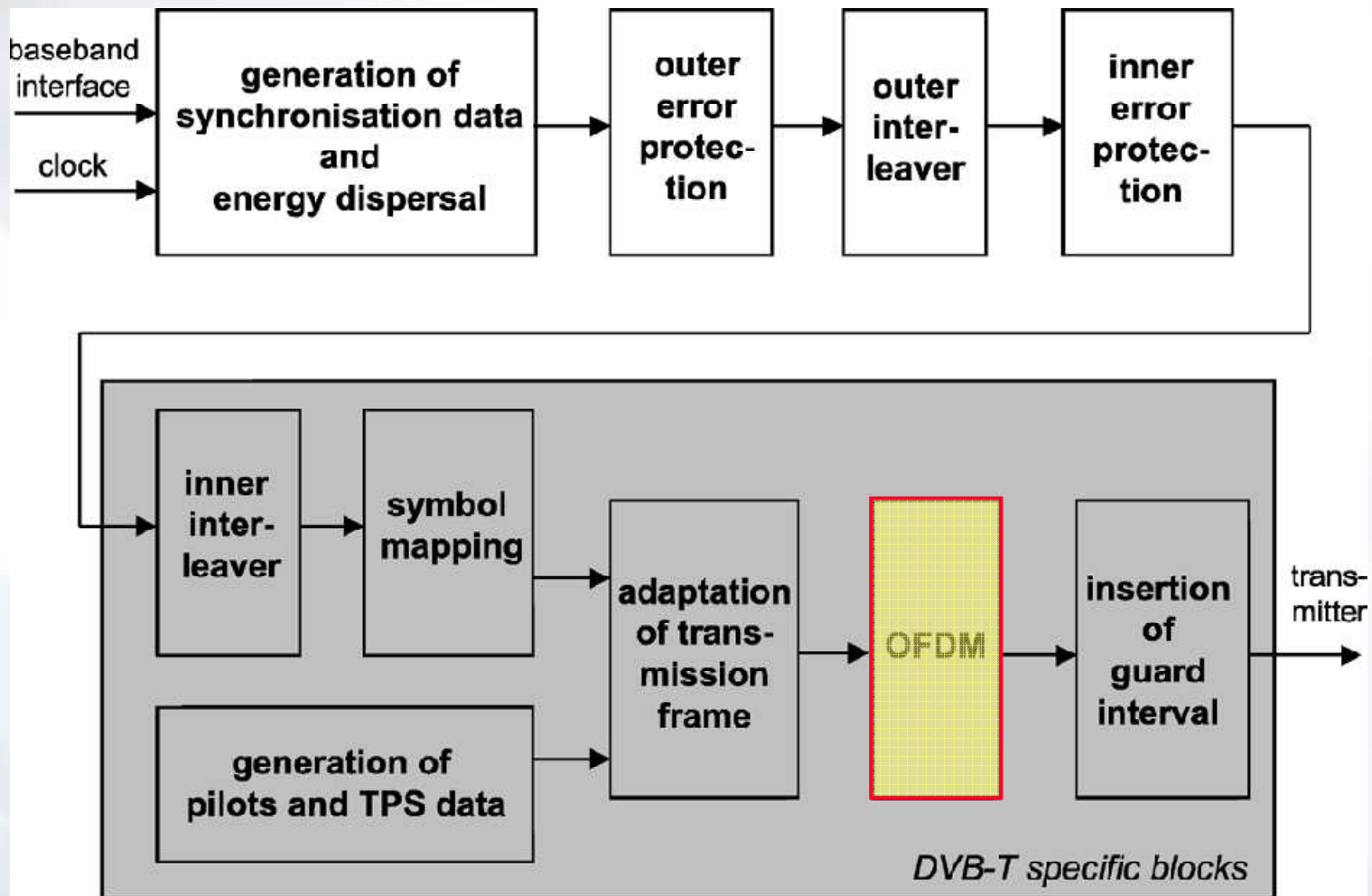

Power saving

- Assuming only two services available, same bitrate, both Time Sliced
 - > On Time is 50% of the Cycle Time
 - > Power Saving nearly 50% (Synchronization Time decreases the achieved level)
- Time Slicing always saves power on a receiver
- The greater the Off Time / On Time relation, the greater power saving achieved

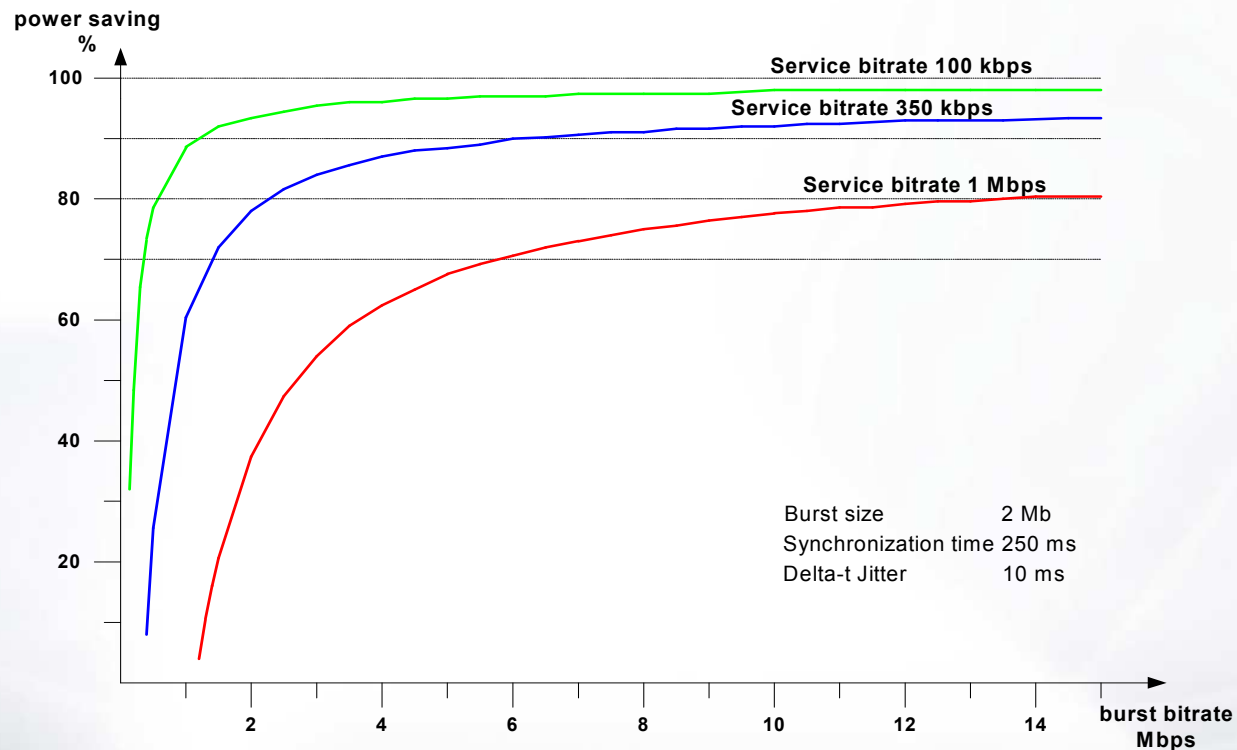

Handover Support due to time-slicing

- In normal DVB-T systems smooth handovers would require two front ends in a single terminal
- Time Slicing offers, as an extra benefit, the possibility to use the same receiver to monitor neighbouring cells during the off-time

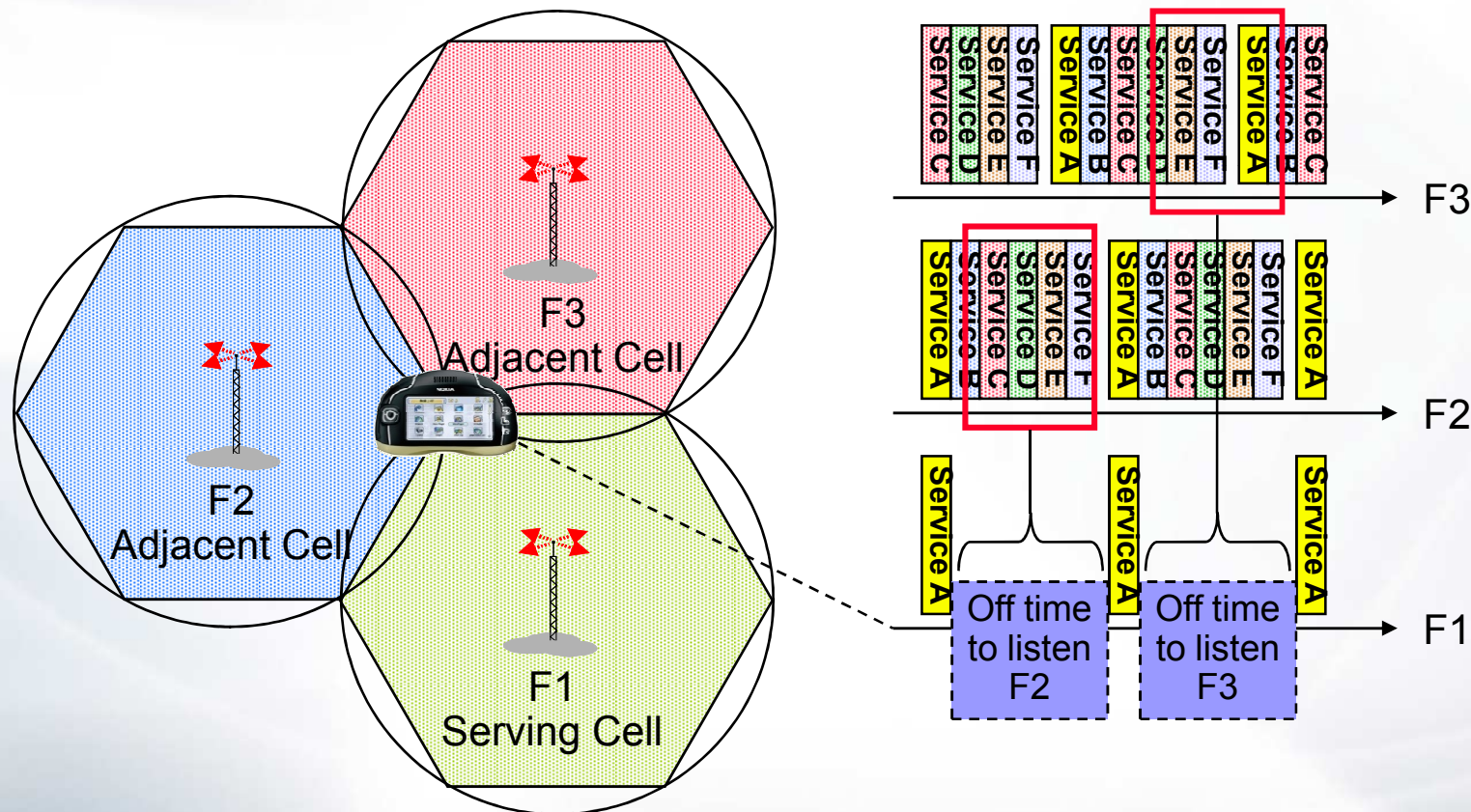

Benefits for all players

- **Consumers:** good, understandable service
- **New revenue opportunities for all industry players**
- **Media & broadcasters:** re-use of popular content and new distribution platform
- **Broadcast network operators:** operating new DVB-H networks



- **Mobile operators:** Offering Mobile TV services to customers and additional opportunities for interactive services
- **Regulators:** good use for the spectrum released in digital switchover
- **Equipment vendors:** new DVB-H network elements, DVB-H enabled mobile phones

Conclusions on DVB-H

- Based on DVB-T, **backwards fully compatible**
- Gives additional features to **support Handheld** reception
 - **Battery saving**
 - **Mobility** with high data rates, single antenna reception, SFN networks
 - Increased **general robustness**, improved impulse noise tolerance
 - Support for **seamless handover**
- The above have been achieved by adding options
 - **Time-slicing** for power saving
 - **MPE-FEC** for additional robustness and mobility
 - **4k mode** for mobility and network design flexibility
- DVB-H **can share DVB-T multiplex** with MPEG2 services

The System Architecture in a Nutshell

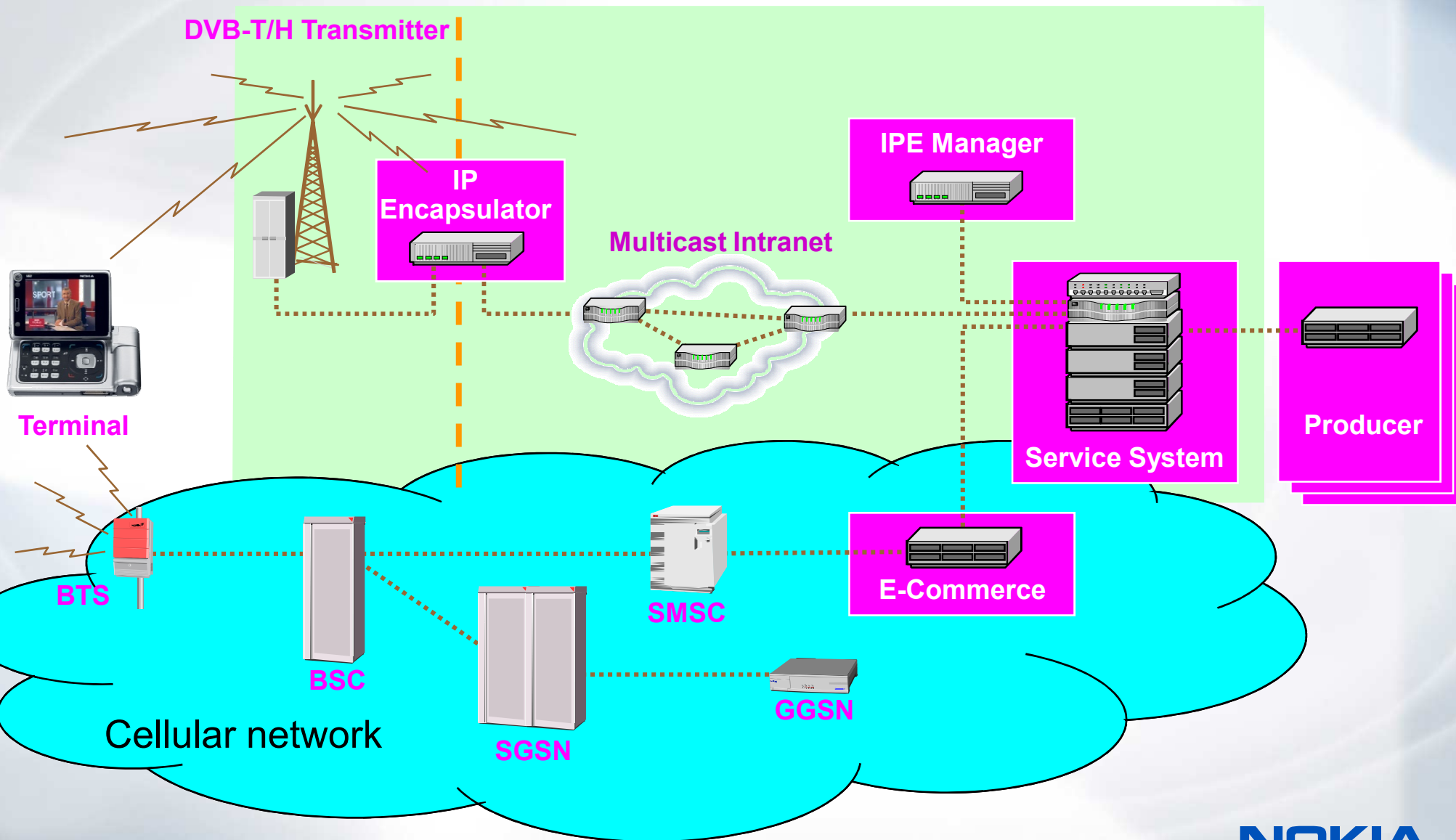

Solution DVB-H (receiver part)

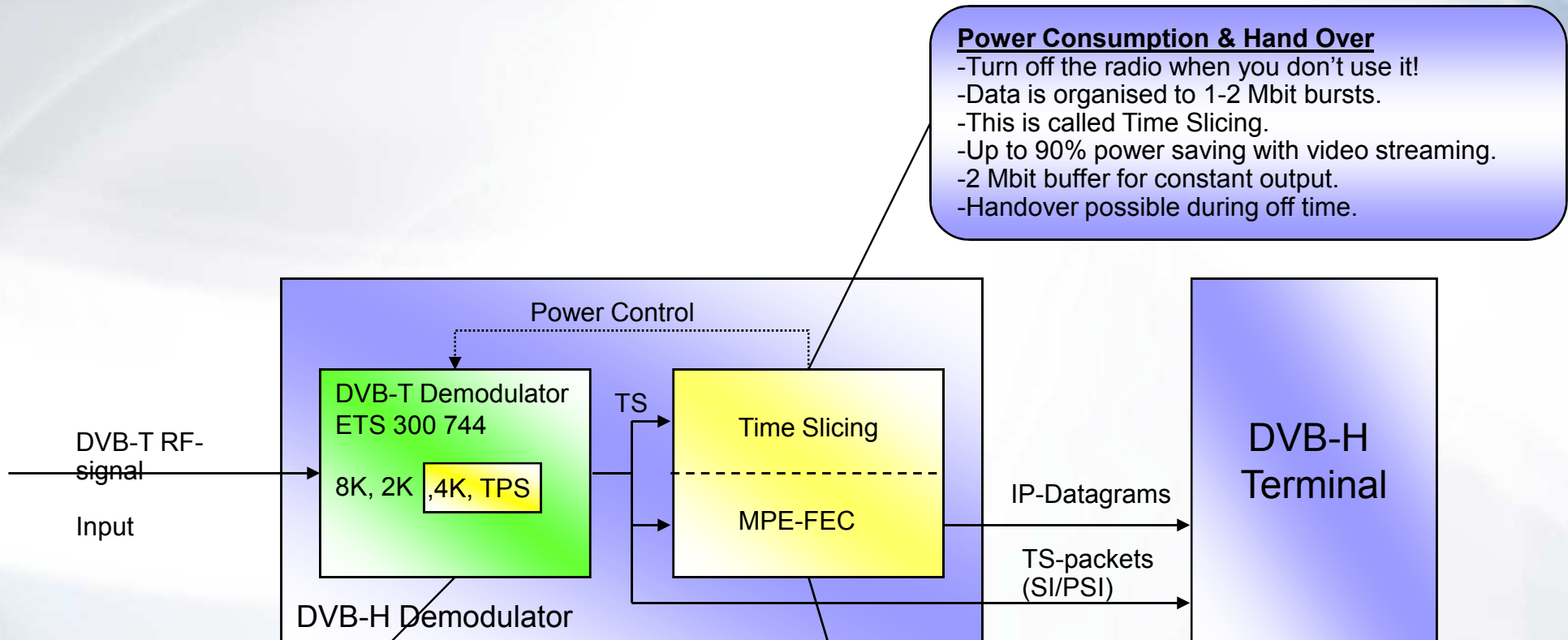

Power Consumption & Hand Over

- Turn off the radio when you don't use it!
- Data is organised to 1-2 Mbit bursts.
- This is called Time Slicing.
- Up to 90% power saving with video streaming.
- 2 Mbit buffer for constant output.
- Handover possible during off time.

Network Design Flexibility and Signalling

- With 4k practical SFN is still possible with very good mobile performance.
- Flexible use of interleavers [8k in 4k or 2k].
- New TPS bits to signal Time Sl. and MPE-FEC.
- Cell id is mandatory.
- Very low additional complexity.

Mobile Performance

- New error correction (RS) for the MPE-sections.
- Virtual interleaver re-using Time Slice buffer.
- Doppler and CN-improved in mobile&portable.
- Impulse interference tolerance improved.
- Possibility to vary the level of robustness.

MPE-FEC

- Additional data link layer Reed-Solomon coding for IP datagrams
- RS data delivered in special FEC sections (*virtual interleaving*)
- Reuses Time Slicing buffer (max 2 Mbit)

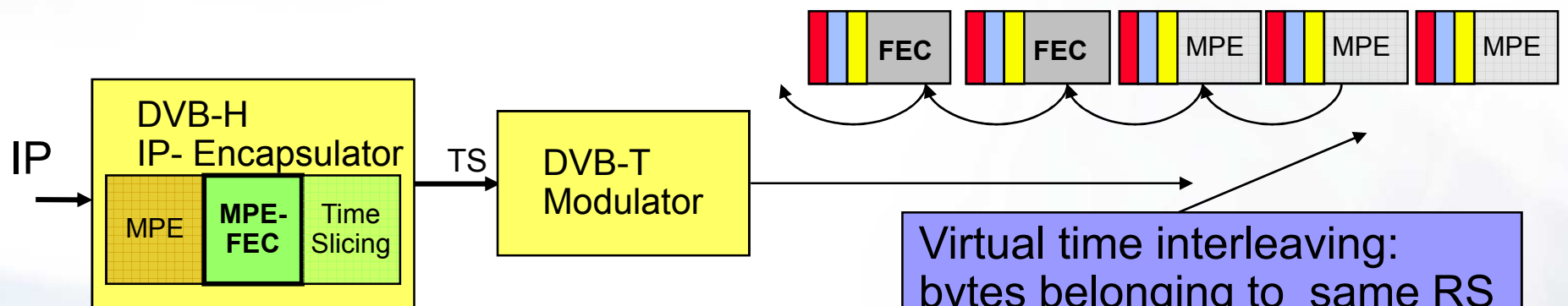

Virtual time interleaving:
bytes belonging to same RS
codeword distributed in time;
*length can be of the order of
0.5 s or even more*

Time slicing 3

- The parameters can be selected from a large range of values: the burst lengths may be shorter or longer; the same with burst intervals
- The power savings in the receiver front-end can typically be of the order of 90 % or higher
- **NOTICE:** Bytes belonging to one service will be spread both in **TIME** and **FREQUENCY**
 - MPE-FEC virtual time-interleaving spreads in time (see later)
 - Time-slicing gives the **whole DVB-T bandwidth** in use (even when sharing with DVB-T!)

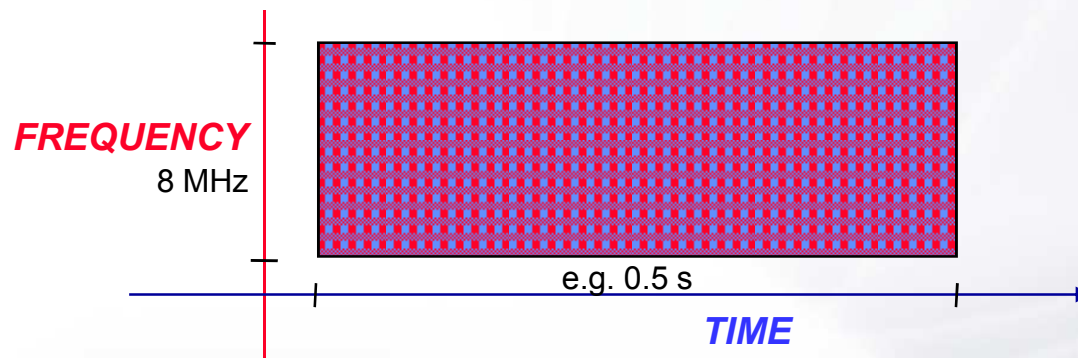

DVB-H Standards Family

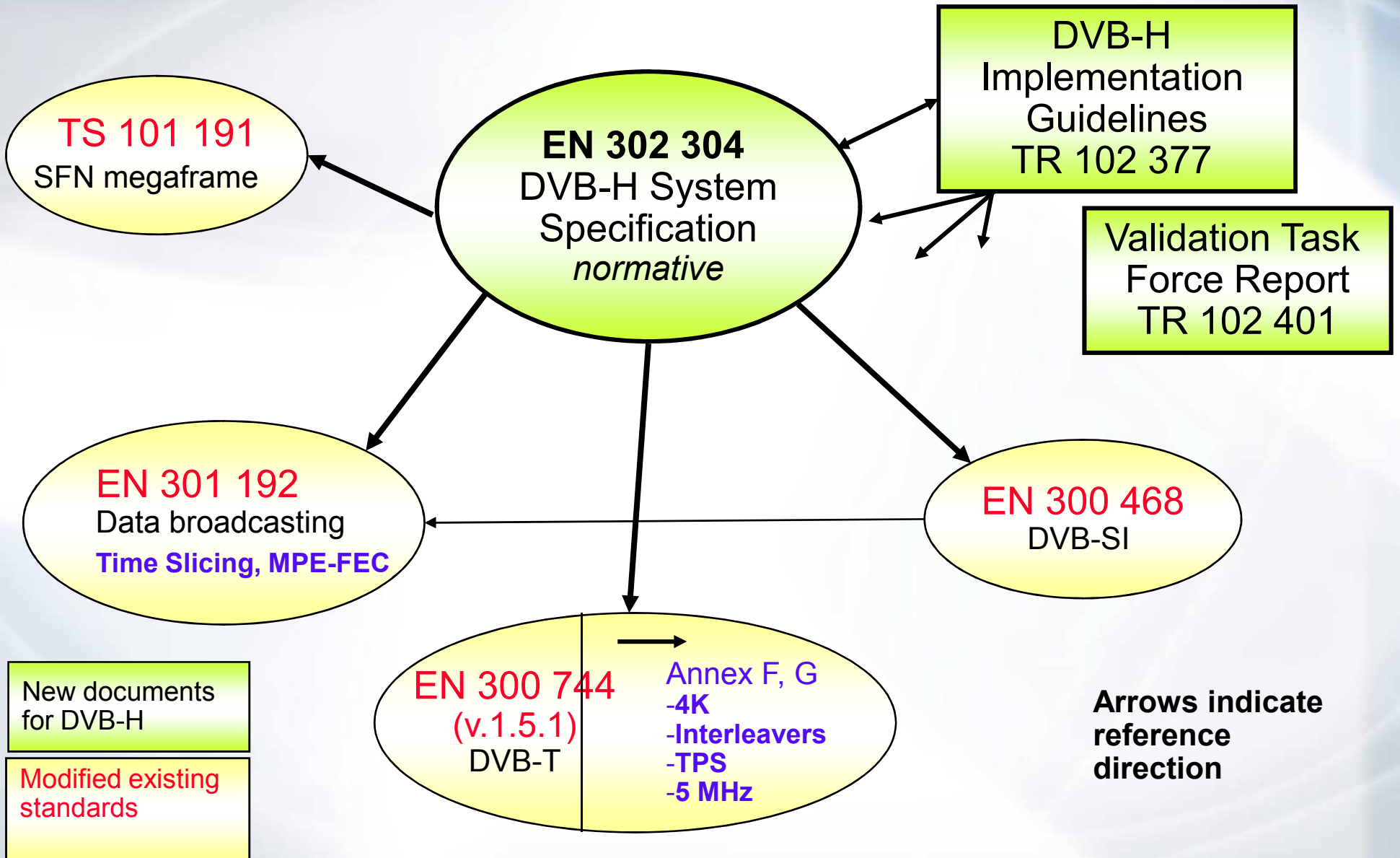

Highlights of the NGH commercial requirements

7	The DVB-NGH specification shall be optimized for outdoor and deep indoor portable and slow mobile reception (pedestrian ≤ 15 km/h).
8	The DVB-NGH specification shall also be optimized for in-vehicle and outdoor mobile vehicular reception (15 to 350 km/h).

Keep mobility

11	The DVB-NGH specification shall be designed to operate at least in the frequency bands III, IV and V, L-band and S-band.
12	DVB-NGH shall be designed to operate in RF channel bandwidths of 1.7, 5, 6, 7, and 8, 10 , 15 and 20 MHz.

New bands & bandwidths

15	The system shall be designed for terrestrial use and it may also contain a satellite component .
----	---

Avoid market fragmentation!

18	The system should support for the transport of the whole stream to transmitters over non synchronous networks such as IP .
19	Individual quality for service components should be possible.
22	The NGH standard should allow for a NGH service to be offered in different qualities. The lower quality being more robust, e.g. based on the use of scalable video coding .

IP support and individual & different service quality; possibly SVC

24	The video, audio or data net throughput shall be maximized for a given reception condition (e.g. C/N), i.e. overheads such as packet headers and metadata should be minimized, without losing functionality.
----	---

Reduce overheads!

Highlights of the commercial requirements 2

28	The preference, in terms of performance improvement, is on robustness and indoor coverage. Recognizing that capacity can be traded for robustness, the overall capacity improvement, for a given robustness, shall be at least 50% compared to DVB-H.
----	--

Major motivation!

29	The DVB-NGH specification should allow for the re-use of DVB-H RF network structures mixing several sites profiles (e.g. from high power/high broadcast towers to low power/low sites similar to 3G sites) and distribution networks as far as possible.
----	--

Guard existing (and future) investments

30	It shall be possible to combine DVB-NGH and DVB-T2 signals in one RF channel
----	--

Could be major competitive edge!

31	The DVB Technical Module is requested to complete the DVB-NGH technical specification(s) by the end of 2011.
----	--

Commercial launch 2012

Notes & disclaimers:

- 1) based on draft document from CM
- 2) Selection of certain requirements here does not mean any preference or indication of importance; purely personal interest 😊

Goals for channel modelling

- To obtain channel models representative of MIMO delivery to a handheld device (or laptop)
- Terrestrial and Satellite
- VHF,UHF, L-Band; dimensionality up to 4x2
- Probably cross-polar receive antennas (+ wired headset)



$$\begin{pmatrix} h_{11} & h_{12} \\ h_{21} & h_{22} \end{pmatrix}$$



$$\begin{pmatrix} \tilde{h}_{11} & \tilde{h}_{12} \\ \tilde{h}_{21} & \tilde{h}_{22} \end{pmatrix}$$

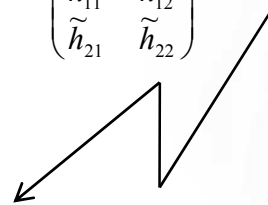



Thank You!

Special thanks for many slides to
Pekka Talmola, Jussi Vesma
& others from Nokia and DVB community