

# -Studio-

The 12 B100/R is a high compliance, bass loudspeaker, featuring wide, single polyurethane foam roll, a 4" voice coil diameter, and a massive, powerful magnet system. These ensure excellent efficiency and extended low frequency response. This model has been designed for use in bass-reflex or closed enclosures, in high quality multi-way systems.

Este altavoz de 12" de alta elasticidad, diseñado para aplicaciones de subwoofer o de graves, está dotado de una suspensión de espuma de media caña que le permite una elongación importante, y bobina de 4" de hilo plano movida por un circuito magnético de gran tamaño que le asegura una amplia respuesta en frecuencia con unos bajos profundos y contundentes. Diseñado para una utilización en recintos bass-reflex de sistemas de gran calidad.



PREDICTED LOW FREQUENCY RESPONSE • Bass-reflex cabinet, Vb=45.00 l, fb=38.0 Hz

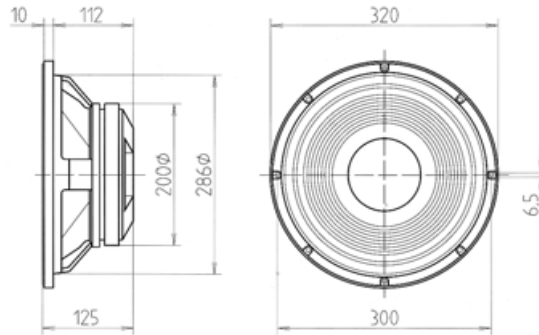
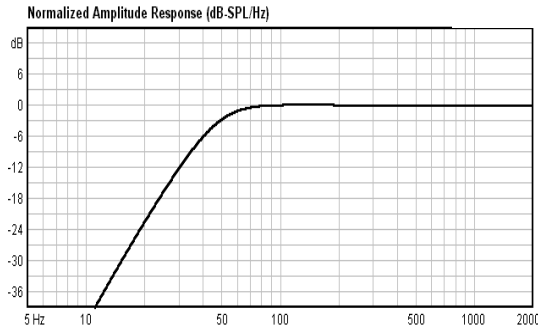

## SPECIFICATIONS

Nominal diameter	300 mm. 12 in.
Rated impedance	8 ohms.
Power capacity*	150 w RMS
Program Power	300 Watts.
Sensitivity	93.6 dB, 2.83v @ 1m @ 2π
Frequency range	25-4000 Hz
Recom. enclosure vol.	40/90 l 1.4/3.15 ft. <sup>3</sup>
Voice coil diameter	100 mm. 4 in.
Magnetic assembly weight	6.4 kg. 14.08 lb.
BL factor	17.2 N/A
Moving mass	0.077 kg.
Voice coil length	12 mm.
Air gap height	7 mm.
X damage (peak to peak)	28 mm.

## MOUNTING INFORMATION

Overall diameter	320 mm. 12.6 in.
Bolt circle diameter	300 mm. 11.8 in.
Baffle cutout diameter:	
-Front mount	286 mm. 11.26 in.
-Rear mount	280 mm. 11.02 in.
Depth	125 mm. 4.92 in.
Volume displaced by driver	5.5 l 0.19 ft. <sup>3</sup>
Net weight	7.4 kg. 16.3 lb.
Shipping weight	8 kg. 17.6 lb.

## MATERIALS

Basket	Die Cast aluminium
Cone	Paper
Surround	Polyurethane foam
Voice coil	Edgewound copper ribbon
Magnet	Ferrite

FREQUENCY RESPONSE & DISTORTION CURVES, MAGN. On axis, 1w @ 1m.

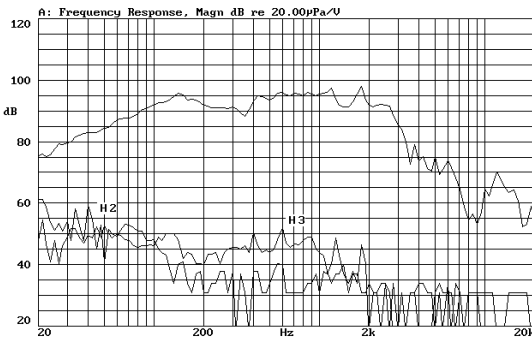

TIME RESPONSE, MAGN.

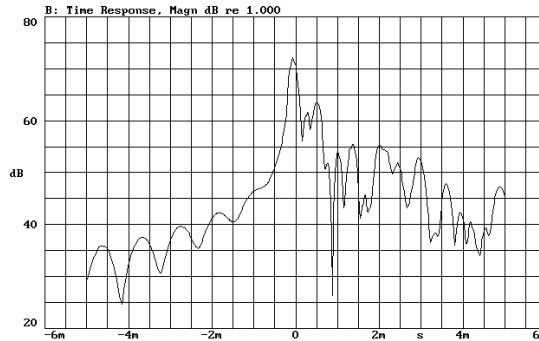

FREQUENCY RESPONSE, PHASE. On axis, 1w @ 1m.

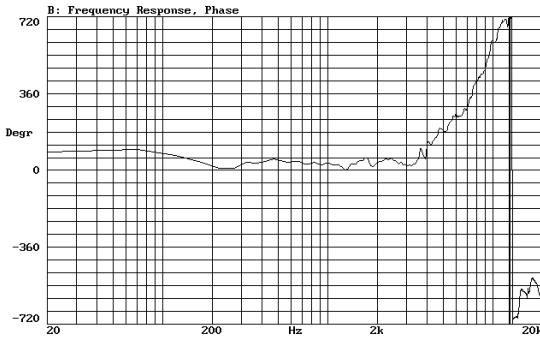

FREE AIR IMPEDANCE CURVE

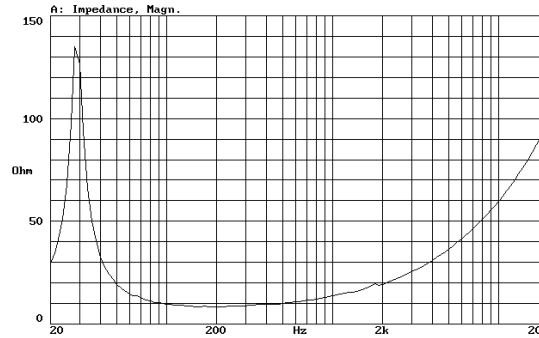

## THIELE-SMALL PARAMETERS\*\*

Resonant Frequency, fs	29 Hz
D.C. Voice Coil Resistance, Re	6.6 ohms.
Mechanical Quality Factor, Qms	6.49
Electrical Quality Factor, Qes	0.31
Total Quality Factor, Qts	0.30
Equivalent Air Volume to Cms, Vas	154 l
Mechanical Compliance, Cms	392 µm/N
Mechanical Resistance, Rms	2.16 kg/s
Efficiency, ηo (%)	1.2
Effective Surface Area, Sd(m <sup>2</sup> )	0.053 m <sup>2</sup>
Maximum Displacement, Xmax	3 mm.
Displacement Volume, Vd	160 cm. <sup>3</sup>
Voice Coil Inductance, Le @ 1kHz	1.3 mH

VOICE COIL INDUCTANCE CURVE

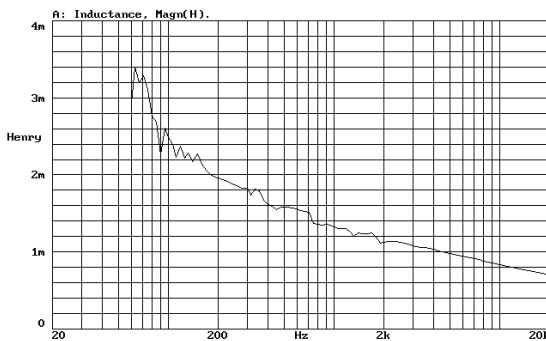

Re + Red(w) CURVE

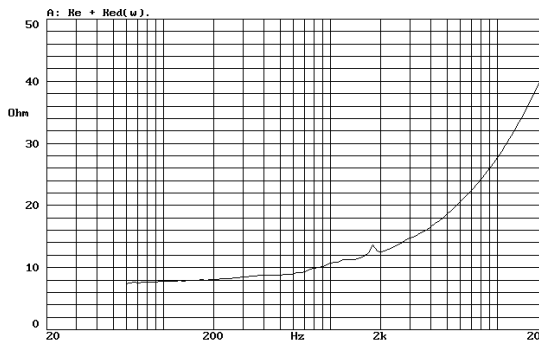

## NOTES

\*The power capacity corresponds to the RMS maximum value that can dissipate the loudspeaker when a sinus signal is applied for a period of at least two hours. Program power is defined as the transducer's ability to handle normal music program material.

\*\* T-S parameters are measured after an exercise period using a preconditioning power test, using a velocity-current laser transducer, and will reflect the long term parameters, once the loudspeaker has been working for a short period of time.

## NOTAS

\*La potencia admisible corresponde a la máxima potencia RMS que puede disipar el altavoz durante al menos dos horas, cuando se le aplica una señal senoidal determinada.

Por potencia programa se entiende la capacidad del altavoz en el manejo de señales transitorias, como sería el proporcionado por el contenido de un pasaje musical normal.

\* Los parámetros T-S han sido medidos después de un periodo de fatiga y estabilización de las suspensiones, mediante transductor laser de velocidad-corriente, y son el reflejo de los parámetros a largo plazo del altavoz, una vez éste haya sido instalado y haya trabajado en un corto espacio de tiempo.