

A close-up, profile view of Tiger Woods smiling broadly. He is wearing a black Nike baseball cap and a red polo shirt. The background is a blurred crowd of spectators at a golf event.

**accenture**

*High performance. Delivered.*

## **IMS architecture overview**

*An overview of IMS architecture and related Accenture experiences.*

**Università Federico II - Napoli, 27 aprile 2007**

# Agenda

---

- **Introduction**

- **IMS and Telecommunications Operators services**
- **IMS architecture**
- **IMS Call Flow**
- **Developing services within IMS**
- **IMS evolution: TISpan architecture**
- **IMS role in Operators technology roadmaps**

# Introduction

---

*The presentation gives an overview of IMS architecture, including how it can help telecommunication operators to achieve their goal of delivering advanced and innovative services, with reference to Accenture International experiences within incumbent, large and minor TelCos.*

*The main topics discussed are:*

- *IMS and Telecommunications Operators services*

***What is IMS and why it is important for TelCo***

- *IMS architecture*

***Elements, functions, protocols and standards behind IMS***

- *IMS role in Operators technology roadmaps*

***How TelCo drives their business towards IMS solutions***

- *Accenture clients and IMS: some highlights*

***IMS experience and VoIP solutions in major Accenture clients***

# Agenda

---

- Introduction
- **IMS and Telecommunications Operators services**
- IMS architecture
- IMS Call Flow
- Developing services within IMS
- IMS evolution: TISPAN architecture
- IMS role in Operators technology roadmaps

# IMS Architecture overview

---

## ***In essence, what is the IP Multimedia Subsystem?***

*The IP Multimedia Subsystem (IMS) provides a unified service architecture for all networks, leveraging the capabilities of IP.*



# What drives IMS Deployment?

*There are both business and technical drivers associated with IMS deployment, that will bring benefits in service creation capabilities as well as in cost optimization*

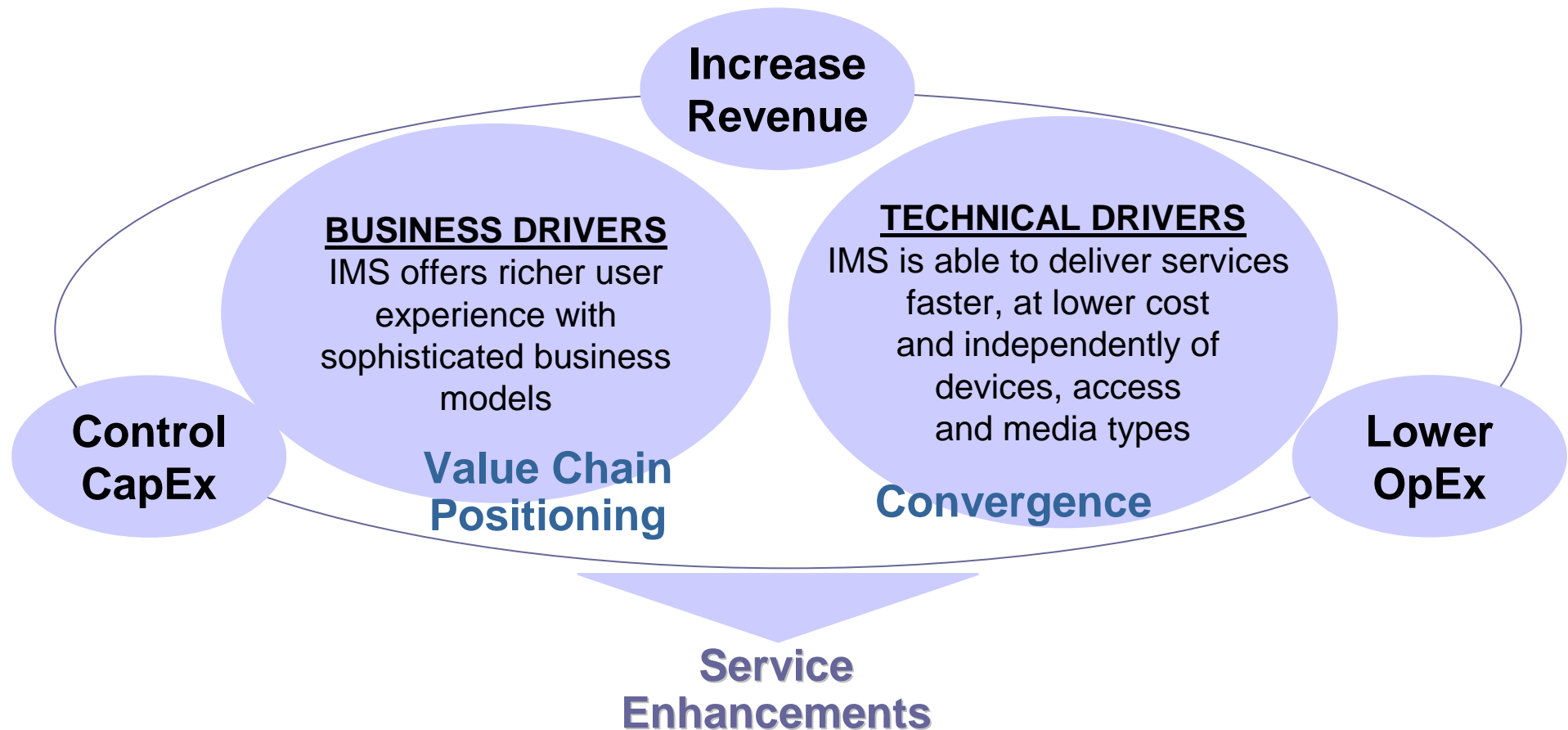

# IMS and Service Enhancements: main keywords

***IMS enables a packet-based network to provide multiple services on single Control/Service Layers via different access network.***

— *Main characteristics* —

- **Access agnostic**
- **Services independent**
- **Open architecture**
- **Multi-device**
- **Vendor independent**

— *Reference architecture* —

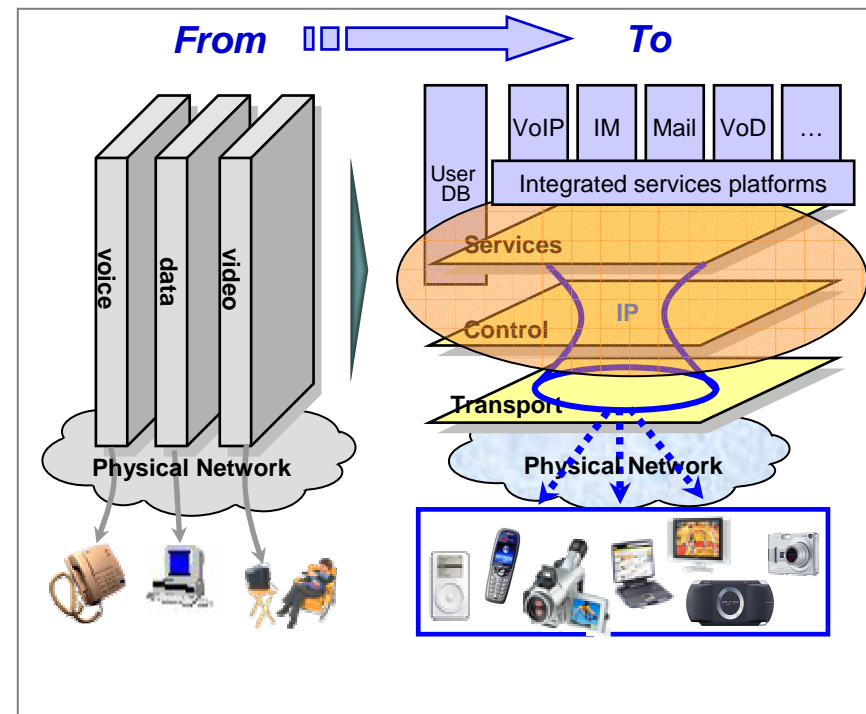

# A controlled path from separate infrastructures to all-IP and IMS

***A (controlled) change of paradigm in the network architectures is a clear requirement for achieving the goal of delivering advanced and innovative services in an efficient way***

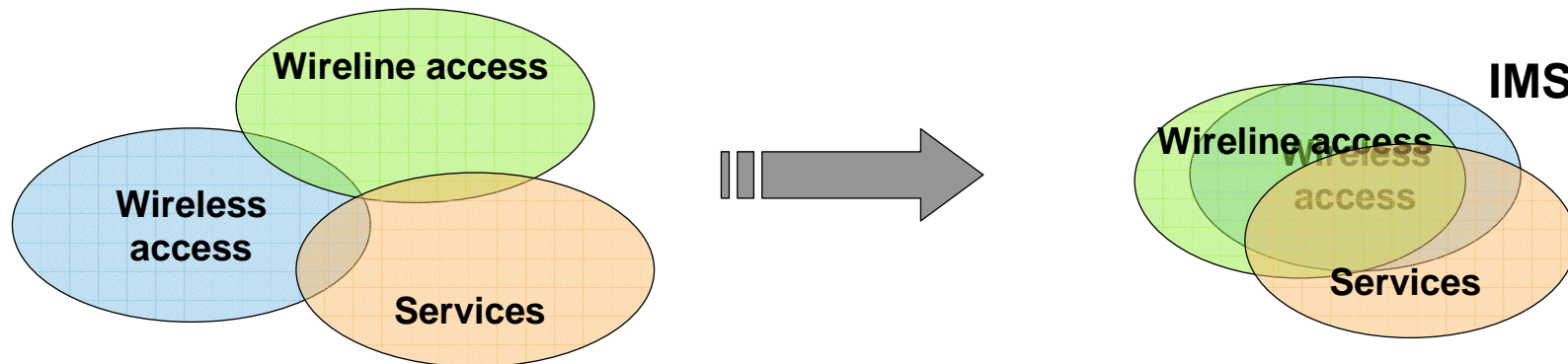

- ❑ services tightly associated with specific terminals and access networks
- ❑ layered networks with separated, non-integrated service control layers
- ❑ non-uniform user profiling
- ❑ IP pervasive but issues in guaranteeing QoS and charging for real-time, integrated services

- ❑ IMS introduces a structured, layered architecture with “standardized” interfaces
- ❑ clear path for integrating 3G world and “internet”
- ❑ ubiquitous access to all services from any device: IMS as access independent and all services developed on IMS are access agnostic
- ❑ uniform support for customer profiling, service access control and charging, integration with “legacy” networks



# Agenda

---

- Introduction
- IMS and Telecommunications Operators services
- **IMS architecture**
- IMS Call Flow
- Developing services within IMS
- IMS evolution: TISpan architecture
- IMS role in Operators technology roadmaps

# IMS architecture

***The IP Multimedia Subsystem is an architecture, originally defined and standardized by the 3GPP consortium, thought to provide multimedia services exploiting an ALL-IP domain.***

- ❑ IP transport offers a cheaper and simpler way to carry multimedia sessions, compared to traditional circuit-switched networks.
- ❑ **A first step toward the all-IP solution is the separation of the Control Layer from the Transport Layer**, which can therefore be implemented exploiting the IP network



- ❑ IMS steps over, redefining and standardizing the **Transport Layer, Control Layer and Application Layer to exploit the IP infrastructure**
- ❑ The IMS solution is therefore an **ALL-IP architecture**. Moreover standardization of functions and interfaces allows:
  - Interoperability with other providers
  - Convergence of services
  - Flexibility and extensibility of the solution

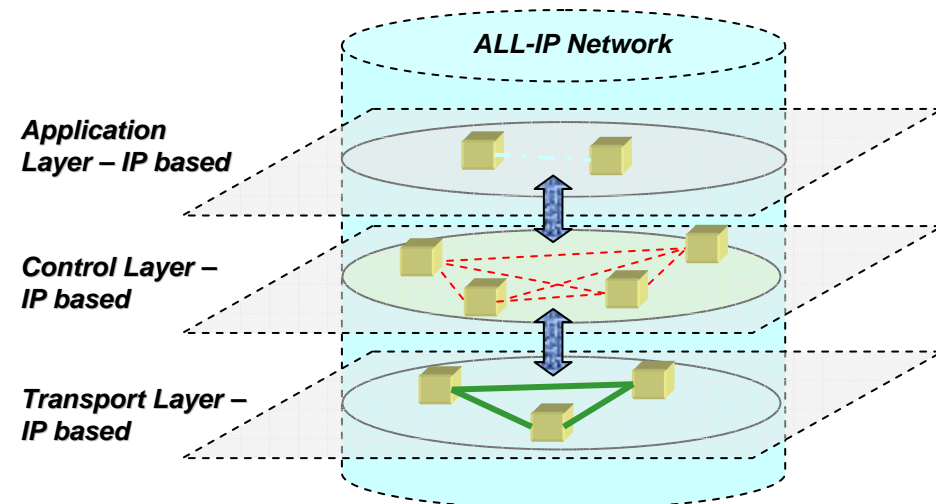

# IMS Overview:

## Standardization Organizations

The **3rd Generation Partnership Project (3GPP)** is a collaboration agreement that was established in 1998 bringing together a number of telecommunications standardization bodies. Scope of 3GPP was to produce globally applicable **Technical Specifications and Technical Reports for a 3rd Generation Mobile Systems** based on GSM, GPRS and EDGE core networks and the radio access technologies.

The European Telecommunications Standards Institute (ETSI) is an independent, non-profit organization, whose mission is to produce telecommunications standards for today and for the future. responsible for standardization of Information and Communication Technologies (ICT) within Europe

**European Telecommunications Standards Institute** is an independent, non-profit organization, whose mission is to produce telecommunications standards for ICT within Europe

Asian **Association of Radio Industries and Businesses**, to conduct research & development on utilization, realization and popularization of new radio systems in telecommunications and broadcasting.

**China Communication Standards Association**, to contribute to the development of information industry

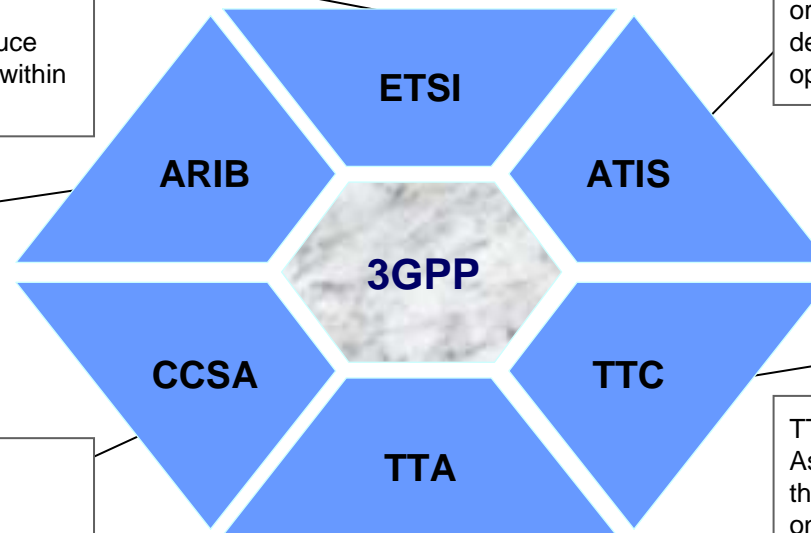

Alliance for Telecommunications Industry Solutions (ATIS) is a U.S.-based organization that is committed to rapidly developing and promoting technical and operations standards for the communications

Japanese Telecommunication Technology Committee, with the purpose of contributing to standardization in the field of telecommunications by establishing protocols and standards

TTA (Telecommunications Technology Association) is an IT standards organization that develops new standards and provides one-stop services for the establishment of IT standards as well as providing testing and certification for IT products

# IMS layers and functions : overview

*The resulting IMS architecture defines elements and functions on three layers:*

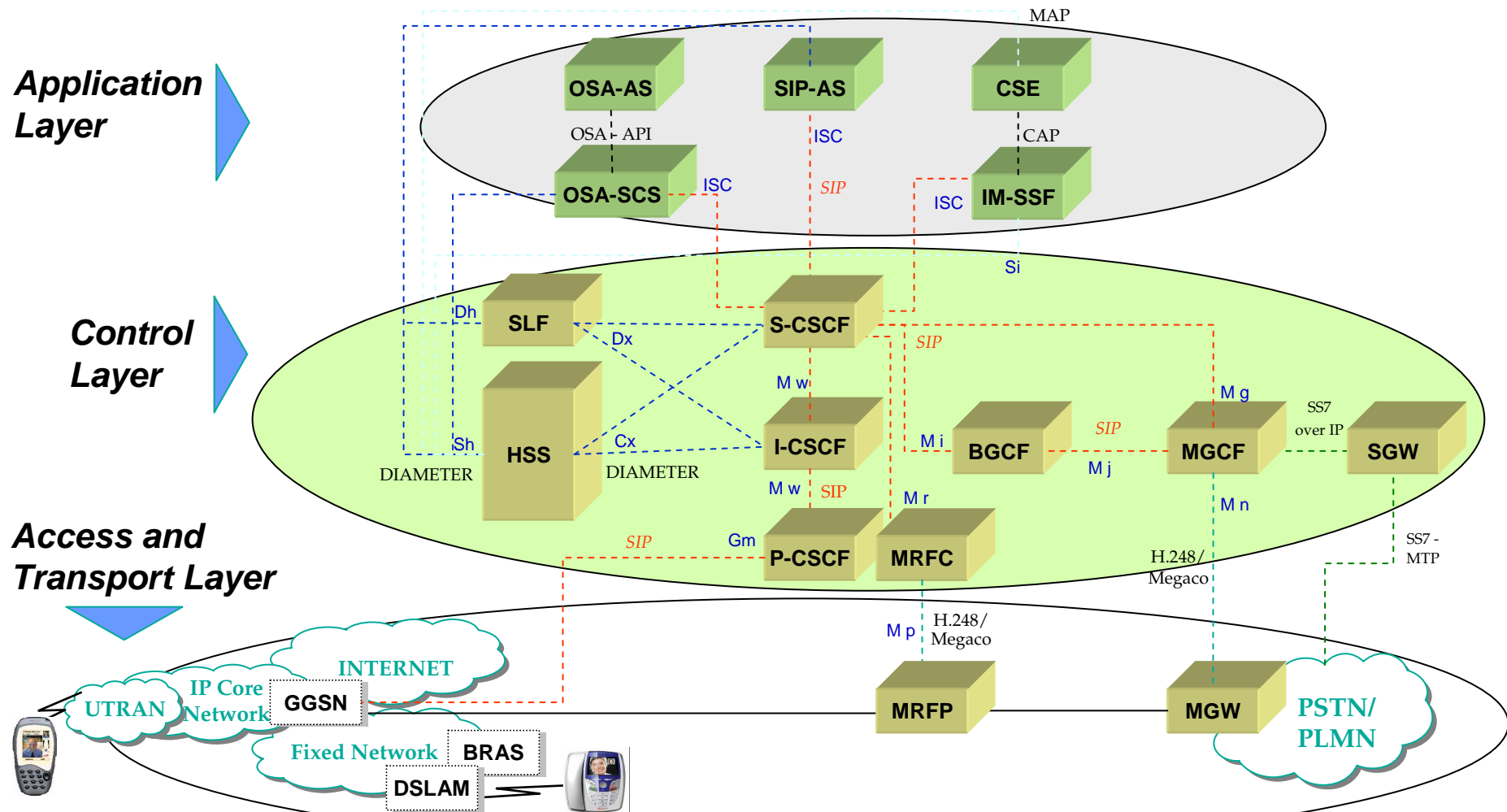

# IMS Core Network Element : CSCF

## Call session control function

**Several types of SIP servers known as CSCF are used to process SIP signaling packets in the IMS domain:**

- Proxy CSCF
- Interrogating CSCF
- Serving CSCF

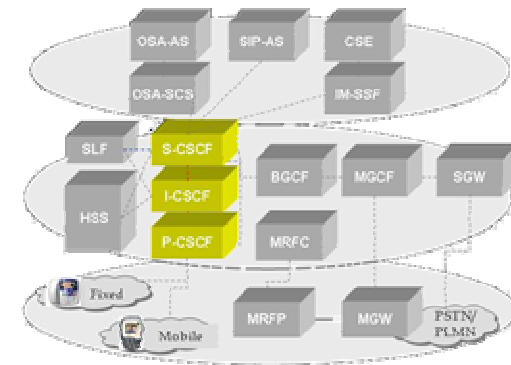

The CSCF elements are responsible for SIP session control and implements the logics for the following functions:

- user authentication
- call routing
- controlling the generation of call detail records (CDRs) for accounting purposes

Each network will typically have multiple CSCFs of each type, allowing load sharing and supporting increased reliability through the use of backup servers.

All the CSCF will use the session initiation protocol (SIP) as signaling protocol. Interaction with other domains using different protocols are performed by dedicated elements which allow protocol translation.

# IMS Core Network Element : P-CSCF

## Proxy Call Session Control Function

**A P-CSCF is the first point of contact for the IMS terminal, and performs the following main functionalities:**

- forwards the registration requests received from the UE to the I-CSCF
- forwards the SIP messages to the S-CSCF that administrate the user, whose address is defined during the registration
- forwards the request and the answers to the UE

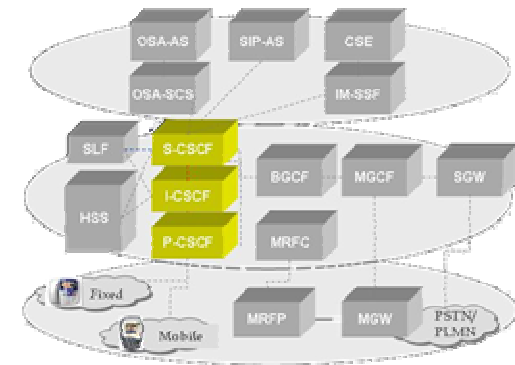

**The P-CSCF is assigned to an IMS terminal during registration, assigned either via DHCP, or in the PDP Context, and does not change for the duration of the registration.**

- Sits on the path of all signalling messages, and can inspect every message
- Authenticates the user and establishes an IPsec security association with the IMS terminal. This prevents spoofing attacks and replay attacks and protects the privacy of the user.
- Can compress and decompress SIP messages using SigComp, which reduces the round-trip over slow radio links
- May include a PDF (Policy Decision Function), which authorizes media plane resources e.g. quality of service (QoS) over the media plane. It's used for policy control, bandwidth management, etc ... The PDF can also be a separate function.
- Can be located either in the visited network (in full IMS networks) or in the home network (when the visited network is not IMS compliant yet).  
Some networks might use a Session Border Controller for this function.

# IMS Core Network Element : I-CSCF

## Interrogating Call Session Control Function

**An I-CSCF is a SIP function located at the edge of an administrative domain.**

- its IP address is published in the DNS of the domain (using NAPTR and SRV type of DNS records), so that remote servers can find it, and use it as a forwarding point (e.g. registering) for SIP packets to this domain.
- its IP address is published in the DNS of the domain (using NAPTR and SRV type of DNS records), so that remote servers can find it, and use it as a forwarding point (e.g. registering) for SIP packets to this domain.
- I-CSCF queries the HSS using the DIAMETER Cx interface to retrieve the user location (Dx interface is used from I-CSCF to SLF to locate the needed HSS only), and then routes the SIP request to its assigned S-CSCF.
- Up to Release 6 it can also be used to hide the internal network from the outside world (encrypting part of the SIP message), in which case it's called a THIG (Topology Hiding Inter-network Gateway).
- From Release 7 onwards this "entry point" function is removed from the I-CSCF and is now part of the IBCF (Interconnection Border Control Function). The IBCF is used as gateway to external networks, and provides NAT and Firewall functions (pinholing).

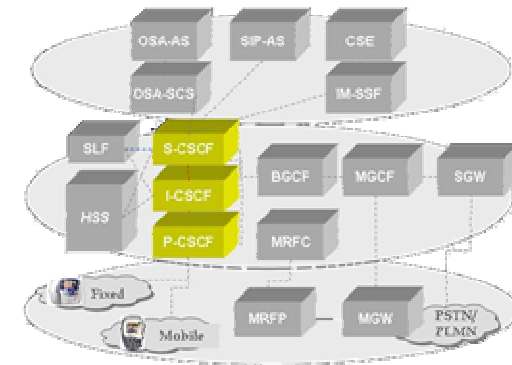

# IMS Core Network Element : S-CSCF

## Serving Call Session Control Function

**An S-CSCF (Serving-CSCF) is the central node of the signalling plane.**

It is a SIP server always located in the home network. The S-CSCF uses DIAMETER Cx and Dx interfaces to the HSS to download and upload user profiles - it has no local storage of the user. All necessary information is loaded from the HSS.

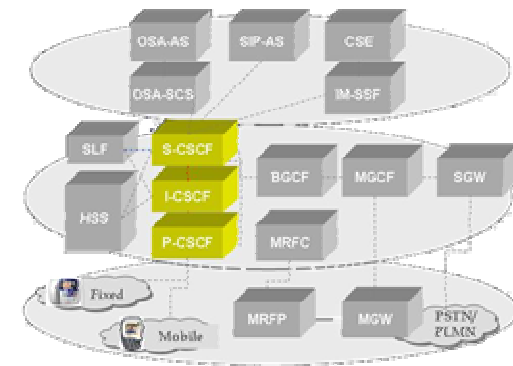

- *it handles SIP registrations, which allows it to bind the user location (e.g. the IP address of the terminal) and the SIP address*
- *it sits on the path of all signaling messages, and can inspect every message*
- *it decides to which application server(s) the SIP message will be forwarded, in order to provide their services*
- *it provides routing services, typically using ENUM lookups*
- *it enforces the policy of the network operator*
- *there can be multiple S-CSCFs in the network for load distribution and high availability reasons. It's the HSS that assigns the S-CSCF to a user, when it's queried by the I-CSCF.*



# IMS Core Network Element : HSS or UPSF

## Home Subscriber Server or User Profile Server Function UPSF

**The HSS is the database of all subscriber and service data.**

HSS is the master user database that supports the IMS network entities that handle the call sessions:

- *it contains the subscription-related information (user profiles), used by the control layer*
- *It contains subscription information used by the service layer*
- *it provides data used to perform authentication and authorization of the user*
- *it can provide information about the physical location of user*

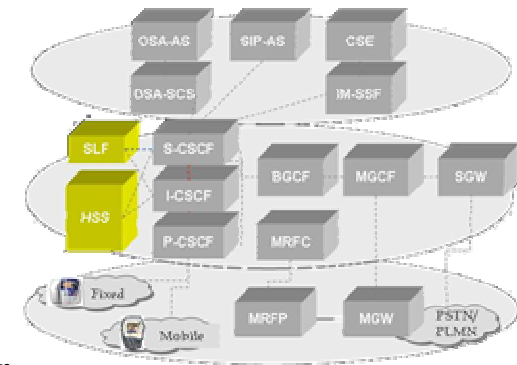

The HSS also provides the traditional Home Location Register (HLR) and Authentication Centre (AUC) functions. This allows the user to access the packet and circuit domains of the network initially, via IMSI authentication.

User Profile is composed by:

- *user identity*
- *allocated S-CSCF name*
- *Registration information and roaming profile*
- *authentication parameters*
- *Control and service information.*

# IMS Core Network Element : SLF

## *Subscription Locator Function*

***An SLF is needed to map user addresses when multiple HSSs are used.***

The Subscription Locator Function (SLF) is used in a IMS network as a resolution mechanism that enables the I-CSCF, the S-CSCF and the AS to find the address of the HSS that holds the subscriber data for a given user identity when multiple and separately addressable HSSs have been deployed by the network operator.

The SLF expose Dx and Dh interfaces, which have the same syntax and semantic of the Cx and Sh interfaces provided by the HSS.

The SLF does not perform any logic on its interfaces, but replies to the requestor with a REDIRECT message, specifying the address of the HSS which is able to fulfill the request received.

Both the HSS and the SLF communicate through the DIAMETER protocol.

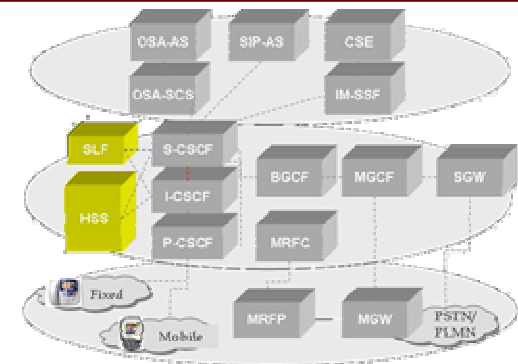

# IMS Core Network Element : MRF

## Media Resource Function

***An MRF is a source for network initiated and network managed media streams in the home network.***

It is exploited for :

- *Playing of announcements (audio/video)*
- *Multimedia conferencing (e.g. mixing of audio streams)*
- *Text-to-speech conversion (TTS) and speech recognition.*
- *Realtime transcoding of multimedia data (i.e. conversion between different codecs)*

Each MRF is further divided into :

- An MRFC (Media Resource Function Controller) is a signalling plane node that acts as a SIP User Agent to the S-CSCF, and which controls the MRFP with a H.248 interface
- An MRFP (Media Resource Function Processor) is a media plane node that implements all media-related functions.

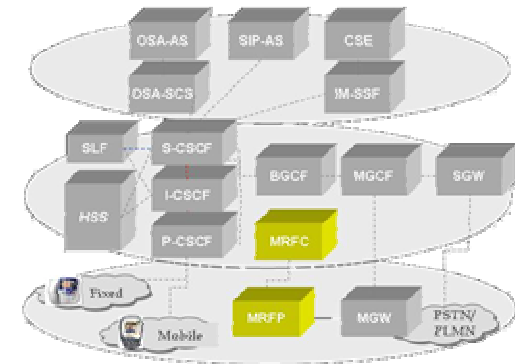

# IMS Core Network Element : BGCF

## Break Out Gateway Control Function

***The Breakout Gateway Control Function is the IMS element that selects the network in which PSTN breakout has to occur.***

A BGCF is used for calls from the IMS to a phone in a Circuit Switched network, such as the PSTN or the PLMN.

BGCF forwards the signaling to the selected PSTN/PLMN network.

If the breakout occurs in the same network as the BGCF then the BGCF selects a MGCF (Media Gateway Control Function) that will be responsible for inter-working with the PSTN, and forwards the signaling to MGCF. Otherwise it forwards signaling to BGCF of another operator network

The MGCF then receives the SIP signalling from the BGCF and manages the interworking with the PSTN network.

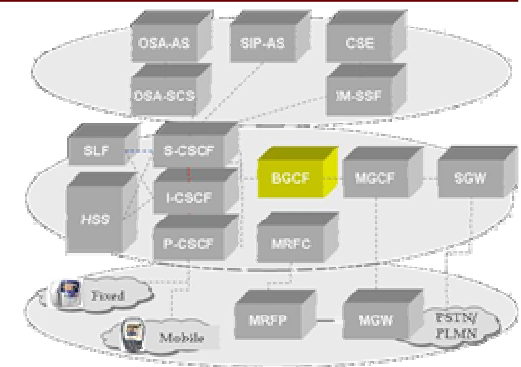

# IMS Core Network Element : PSTN Gateways

## Public Switched Telephony Network Gateways

**The interworking with the Circuit Switched network is realized by several components, for signaling, media and control functionalities:**

### **SGW (Signalling Gateway)**

is the interface with the signaling plane of the Circuit Switched Network (CS). It transforms lower layer protocols as SCTP (which is an IP protocol) into MTP (which is a SS7 protocol), to pass ISUP from the MGCF to the CS network.

### **MGCF (Media Gateway Controller Function)**

- Performs call control protocol conversion between SIP and ISUP
- interfaces the SGW over SCTP
- controls the MGW resources with a H.248 interface.

### **•MGW (Media Gateway)**

- Interfaces the media plane of the CS network, by converting between RTP and PCM.
- It can also perform media transcoding, when the codecs used do not match (e.g. IMS might use AMR, PSTN might use G.711).

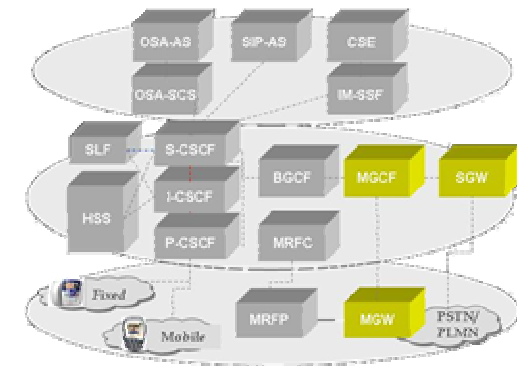

# IMS Core Network Element : AS

## Application Servers

**Application Servers host and execute services, and interface with the S-CSCF using SIP.**

This allows third party providers an easy integration and deployment of their value added services to the IMS infrastructure.

Examples of services are:

- Caller ID related services (CLIP, CLIR, ...)
- Call waiting, Call hold, Call pick up
- Call forwarding, Call transfer
- Call blocking services, Malicious Caller Identification
- Lawful interception
- Announcements, Digit collection
- Conference call services
- Location based services
- SMS, MMS
- Presence information, Instant messaging
- Voice Call Continuity Function (VCC Server) or Fixed Mobile Convergence

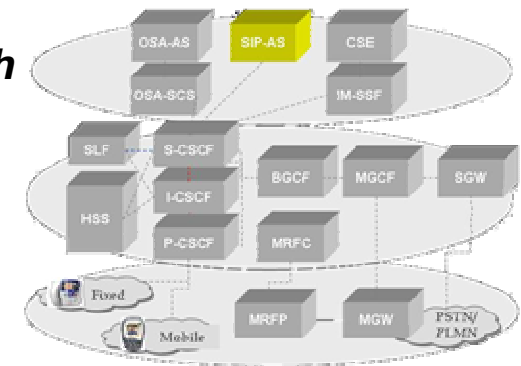

# IMS Core Network Element : IM-SSF

## IP Multimedia - Service Switching Function

***The IM-SSF is the node in the IMS domain which provides interworking between the SIP session control and the Intelligent Network of traditional networks.***

It allowing service requests to be forwarded to legacy service delivery platforms such as IN-based SCPs.

IM-SSF provides intelligent gateway functionality between the SIP-based IMS network and IN systems that use protocols such as CAMEL, INAP, AIN and MAP

This functionality is critical for the rollout of new, converged offerings, while continuing service to high-value customers.

The IM-SSF also enables access to subscriber information retrieved from the HSS over the Si interface using the MAP protocol.

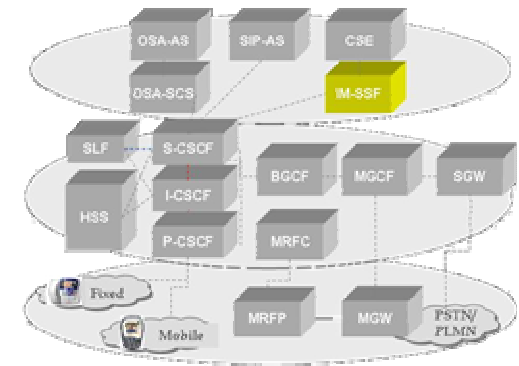

# IMS Core Network Element : Service Layer Interfaces

*The IMS control layer implements several interfaces toward the service layer which enables the user to access to service logics implemented by heterogeneous resources and application servers.*

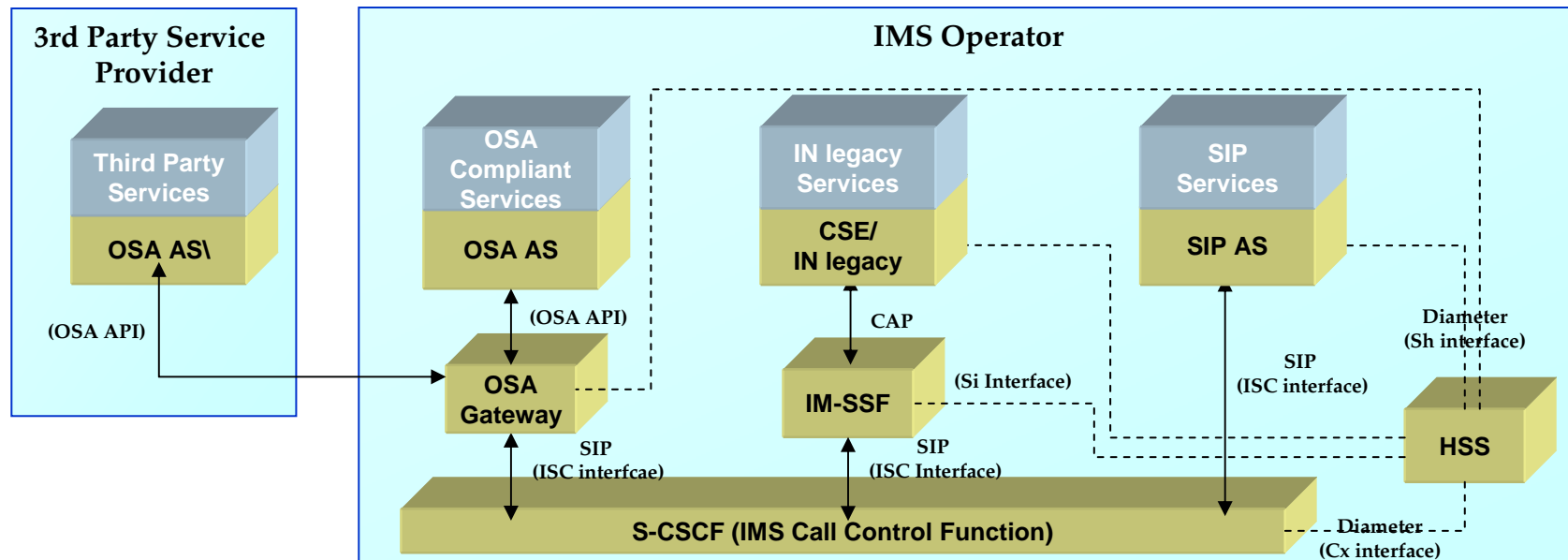

- ISC (between S-CSCF and OSA Gateway/IM-SSF/SIP AS) allows to receive/notify SIP messages from/to the S-CSCF to realize the service session control
- Cx between S-CSCF and HSS is used to retrieve/update the subscriber profile data
- Sh between HSS/OSA- Gateway/SIP-AS is used to retrieve/update the subscriber profile data related to the service. The HSS is responsible for policing what information will be provided to each individual application server.
- Si between HSS and IM-SSF is used to retrieve/update the subscriber profile data related to IN services



# Agenda

---

- Introduction
- IMS and Telecommunications Operators services
- IMS architecture
- **IMS Call Flow**
- Developing services within IMS
- IMS evolution: TISPAN architecture
- IMS role in Operators technology roadmaps

# Example: Registration and Basic Call Flow

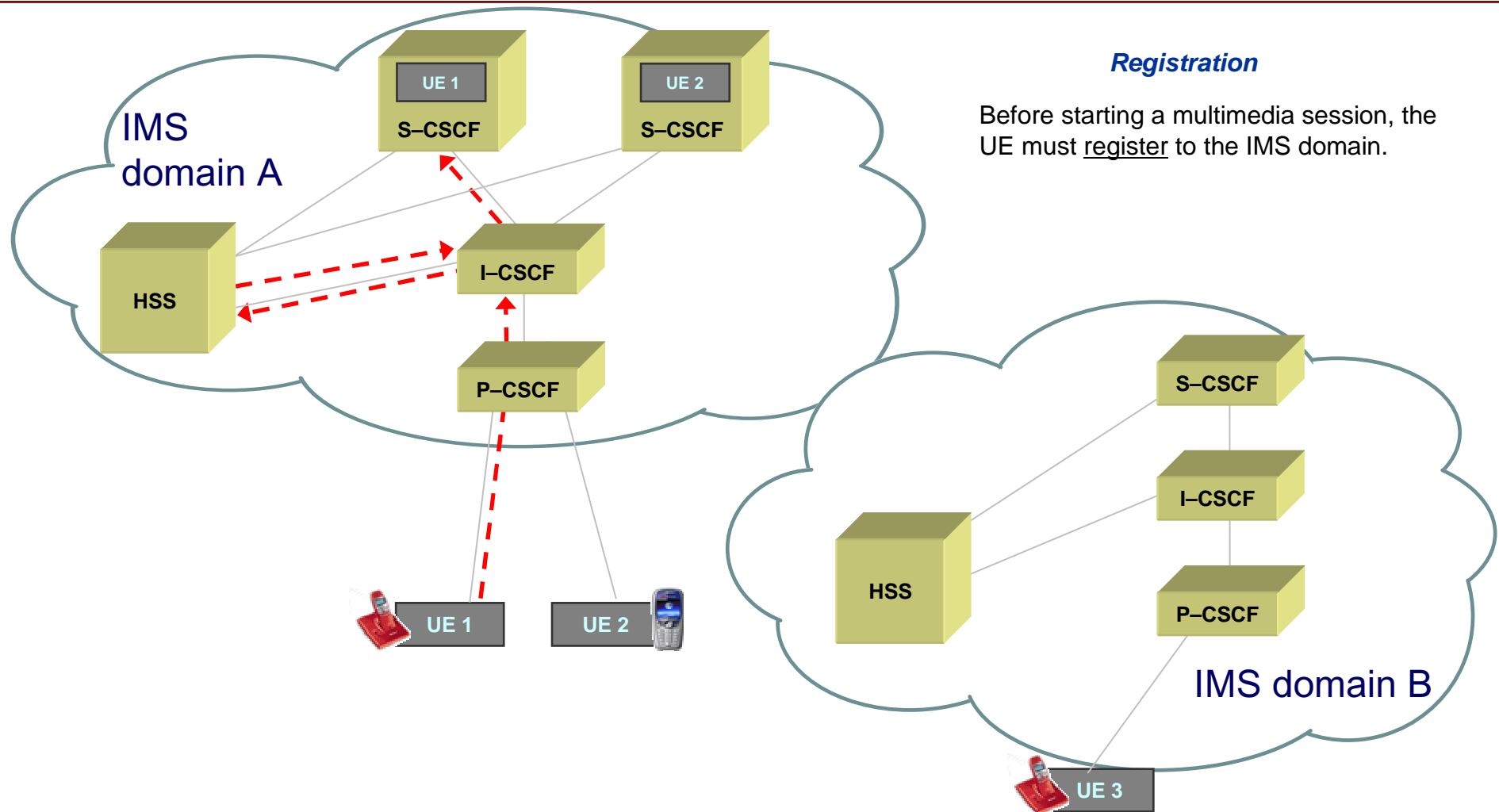

# Example: Registration and Basic Call Flow

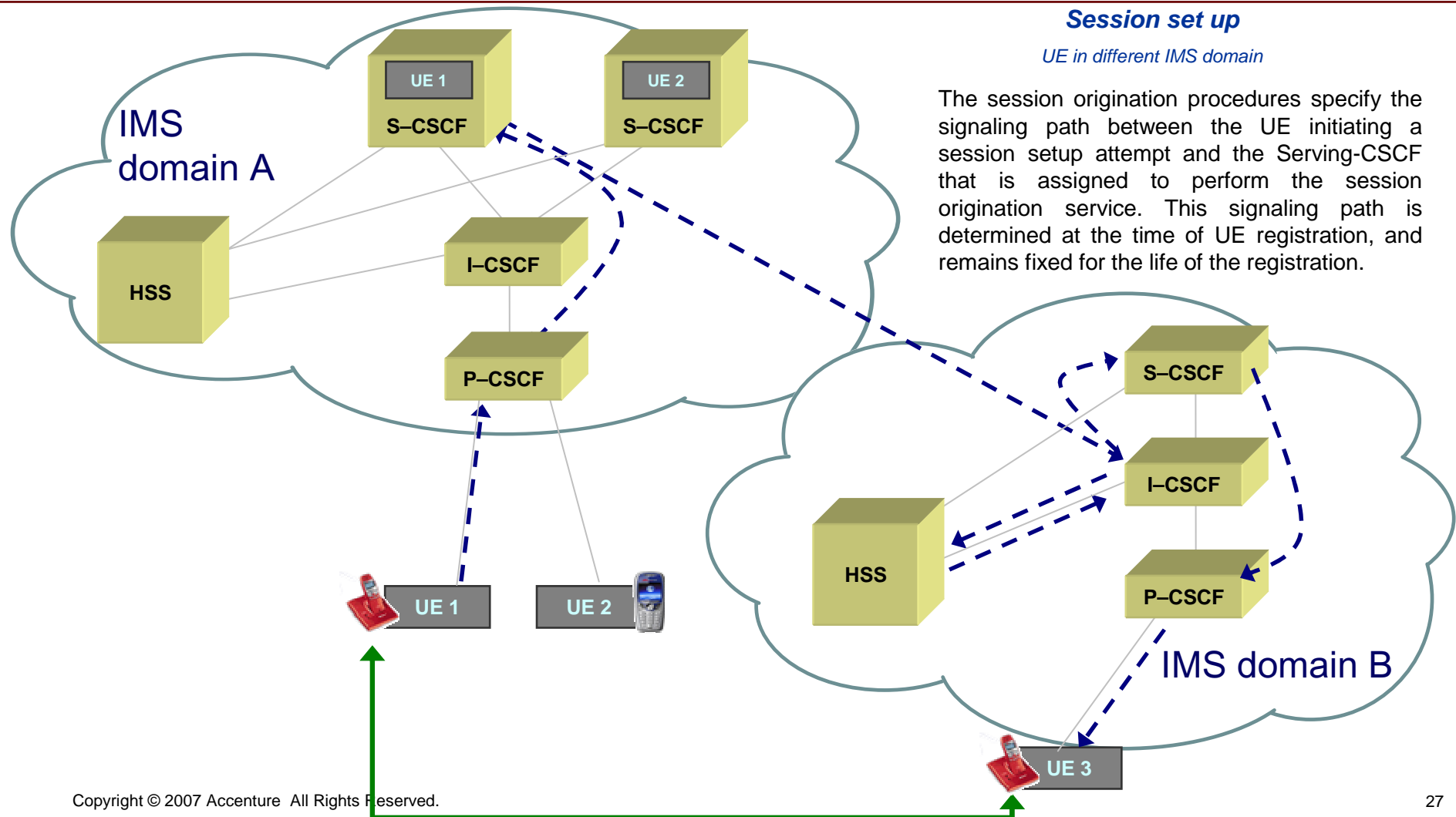

# Example: Registration and Basic Call Flow

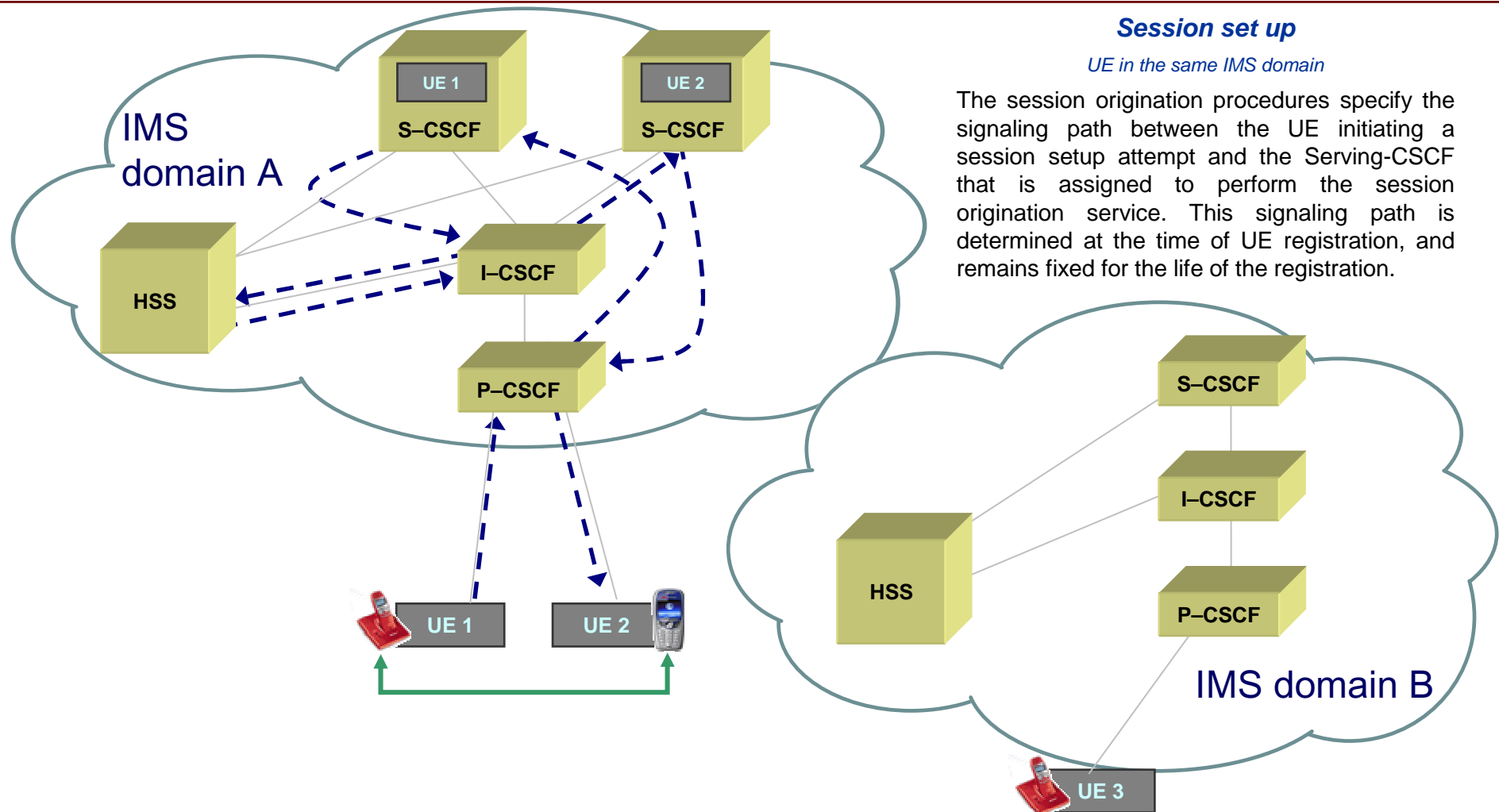

# Example: Call Flow with services : Call Barring and Number Portability

User A initiates a call to a number that has been ported to an external network.

User A has the Call Barring service, which prevents him to call 1xx numbers, hence the S-CSCF triggers the Application Server to apply the CB logic. The AS retrieves the profile associated to User A from the HSS, perform the service logic, and sends back the message to the S-CSCF allowing the call.

Call control comes back to the CSCF, which interrogates the HSS and recognizes the dialed number has been 'ported' to an external network. The S-CSCF forward the request to the IM-SSF to apply the Number Portability service on the Intelligent Network.

The IM-SSF forwards the request to the SCP using INAP, which responds with the new Routing Number of the User B.

The IM-SSF responds to the S-CSCF with the new number.

The CSCF completes the signaling phase forwarding the call to the BGCF, and finally to the called party User B.

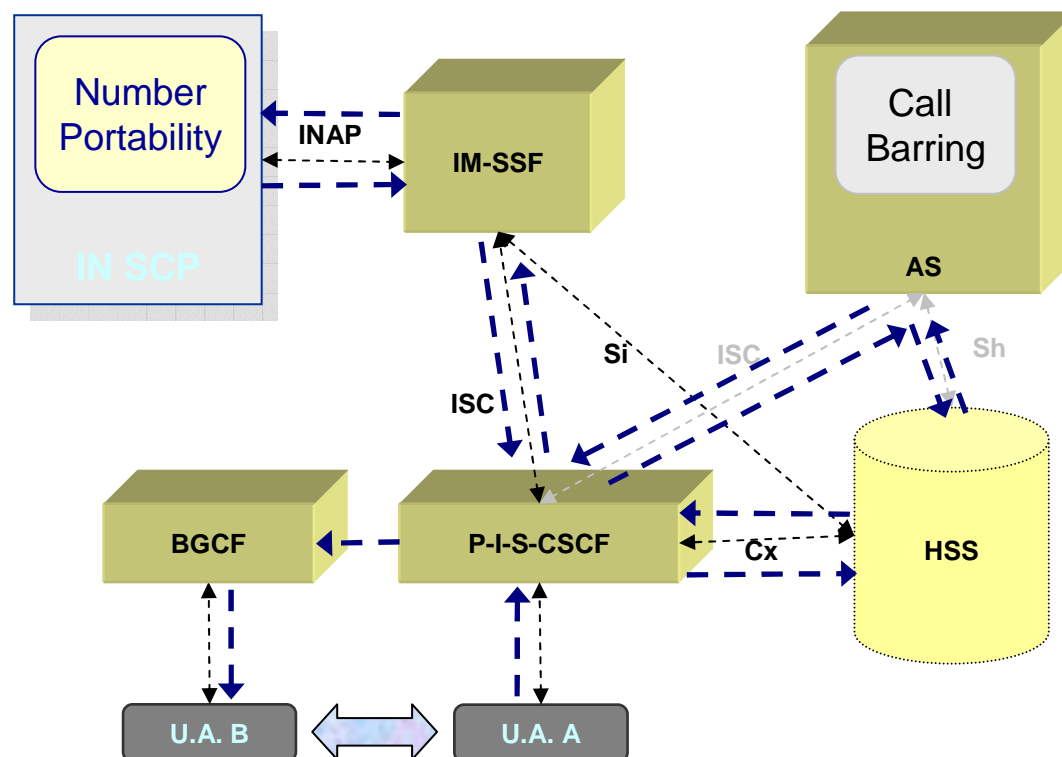

# Agenda

---

- Introduction
- IMS and Telecommunications Operators services
- IMS architecture
- IMS Call Flow
- **Developing services within IMS**
- IMS evolution: TISPA architecture
- IMS role in Operators technology roadmaps

# Developing and deploying applications

- Applications deployed on ASs are the basic blocks used to develop services.
- Services can be provided directly by a single application or can be the result of the orchestration of several applications, eventually hosted on different Application Servers.
- Application Servers are the execution environments for applications, providing framework facilities such as protocols and interface support, database connections, security, monitoring and more...

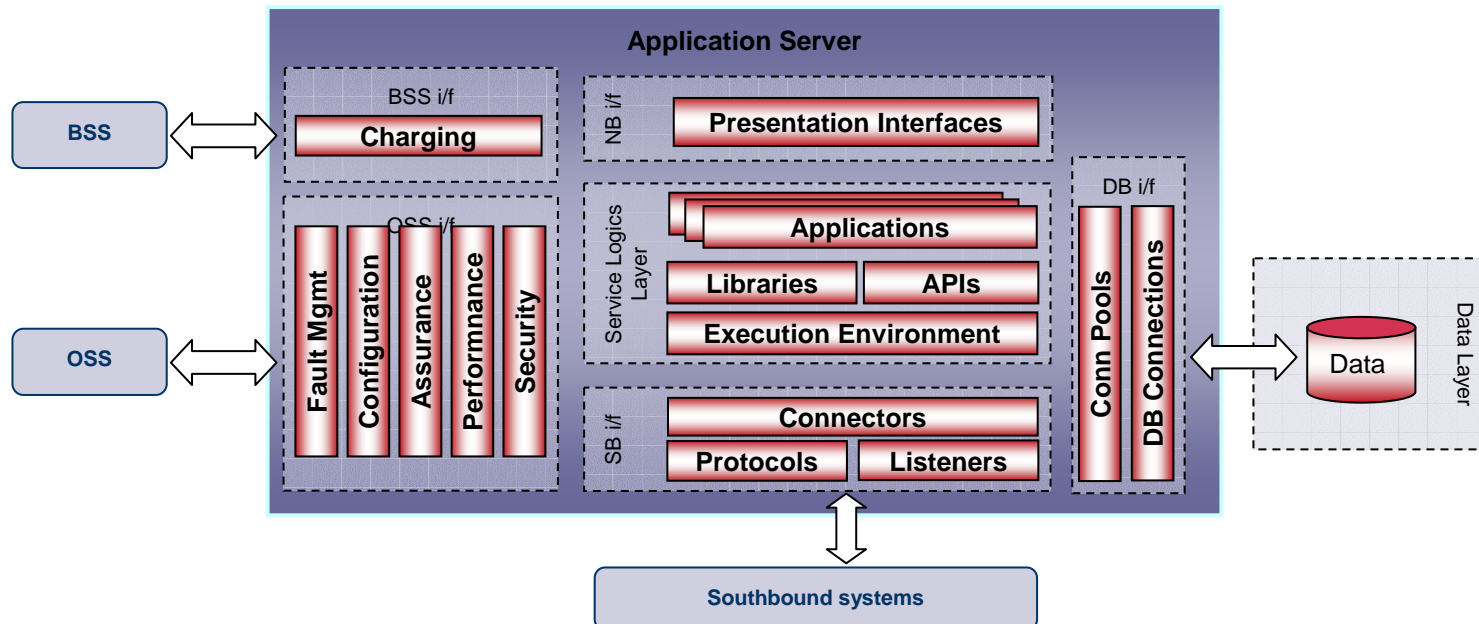

# SLEE and Servlet-Container architectures

---

- Application Containers can be based on different paradigms, depending on the structure of the application execution environment and on the technique used to convey messages between different components inside the application server.

Two main execution environments types are currently exploited to develop application servers:

Message Driven, Servlet Containers	Event Driven, SLEE
<b>Synchronous execution:</b> <ul style="list-style-type: none"><li>• Logics are activated by requests received from the network</li></ul>	<b>Asynchronous execution</b> <ul style="list-style-type: none"><li>• Requests generate events. Service logics are notified of raised events, and activate services</li></ul>
<b>Service model: Request/response</b> <ul style="list-style-type: none"><li>• Direct association between messages and logics</li></ul>	<b>Service model: Publish/subscribe</b> <ul style="list-style-type: none"><li>• Requests have not a direct connection with service blocks</li></ul>
<b>Coarse grained ('Grana grossa')</b> <ul style="list-style-type: none"><li>• Does not allow to manage same request in different way</li></ul>	<b>Fine grained ('Grana Fine')</b> <ul style="list-style-type: none"><li>• Allows more granularity in management of the requests</li></ul>



# Application Architectures: SLEE

**SLEE (Service Logic Execution Environment) architecture is based on an execution model with application hosted as independent service building blocks (SBB).**

- Each SBB can be triggered and activated by one or more events, generated inside the SLEE
- Interfaces are realized implementing Resource Adaptors, which manage listeners and protocols, and are able to raise specific events when interrogated by network requests.
- The SLEE environments manages the entire lifecycle of events, applying subscribe/notify and routing rules between RAs and SBBs.

***This kind of service environment has been specifically thought for TelCo operators, as allows following features:***

- Modular development of service logics
- Easy combination of different Service Block to provide convergent services
- Resource Adaptors can be added or extended without modifying the service logics implemented inside SBBs

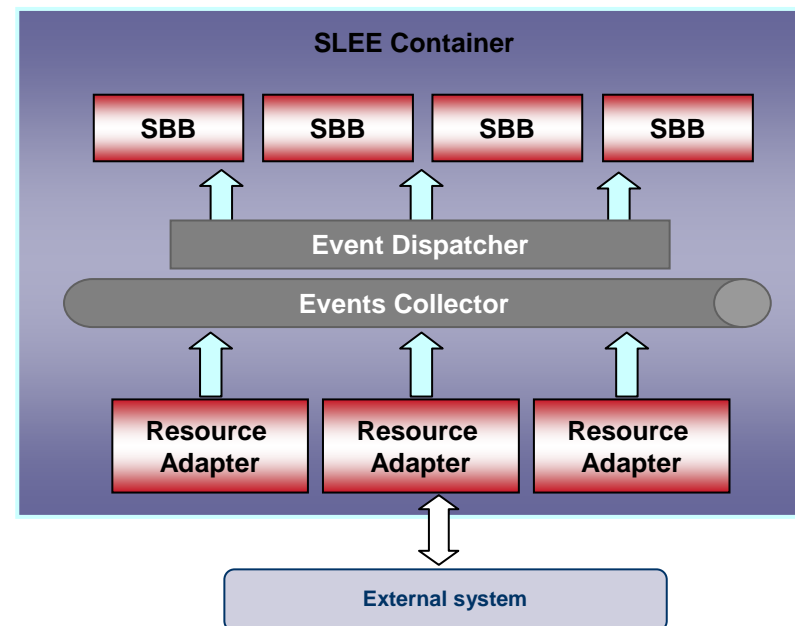

# Application Architectures: Servlet Containers

**Servlet Containers are execution environments which bind the execution of a service logic to the receiving of a particular request.**

- Service Logic lifecycle is entirely managed by the environment
- Requests are associated to service logics depending on the type of message received (servlet model)
- Service Logics are activated synchronously with request elaboration
- Combination of service logics is managed redirecting messages inside the container

**The servlet paradigm can be used implementing adaptors for several protocols, allowing the development of fast network oriented services:**

- Service Logics are directly connected to network messages
- Can manage queuing, overloading and prioritization of requests
- Protocols and interfaces can be added implementing new listeners

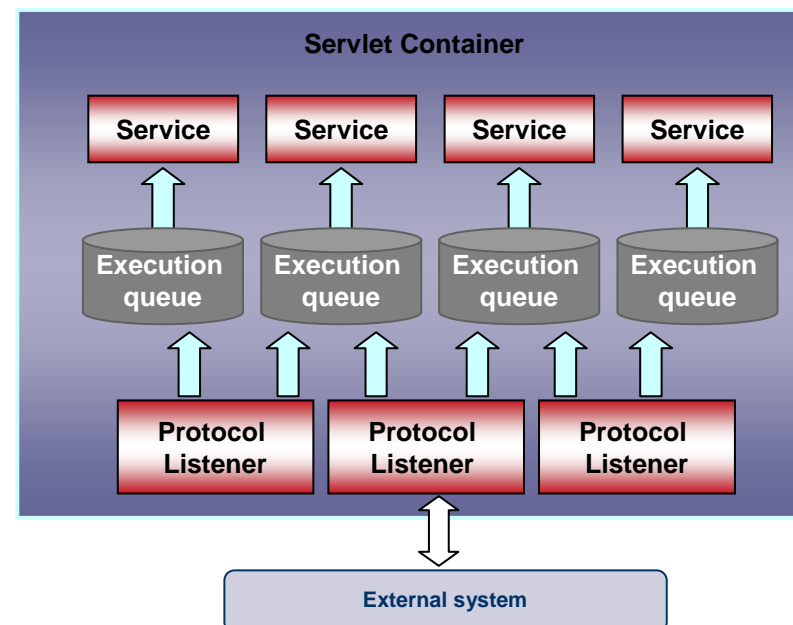

# Agenda

---

- Introduction
- IMS and Telecommunications Operators services
- IMS architecture
- IMS Call Flow
- Developing services within IMS
- **IMS evolution: TISPAN architecture**
- IMS role in Operators technology roadmaps

# IMS evolution: NGN Tispan Architecture

*The Telecoms & Internet converged Services & Protocols for Advanced Networks (TISPAN) is a standardization body of ETSI, specializing in fixed networks and Internet convergence.*

TISPAN is the ETSI core competence centre for fixed networks and for migration from switched circuit networks to packet-based networks with an architecture that can serve in both to create the Next Generation Network.

- This focus on fixed accesses together with the choice of using the IMS network in the core architecture led to new requirements and to an evolution of the original IMS solution. TISPAN and 3GPP are now working together to define a harmonized IMS-centric core for both wireless and wireline networks, enabling new convergent accesses and services.

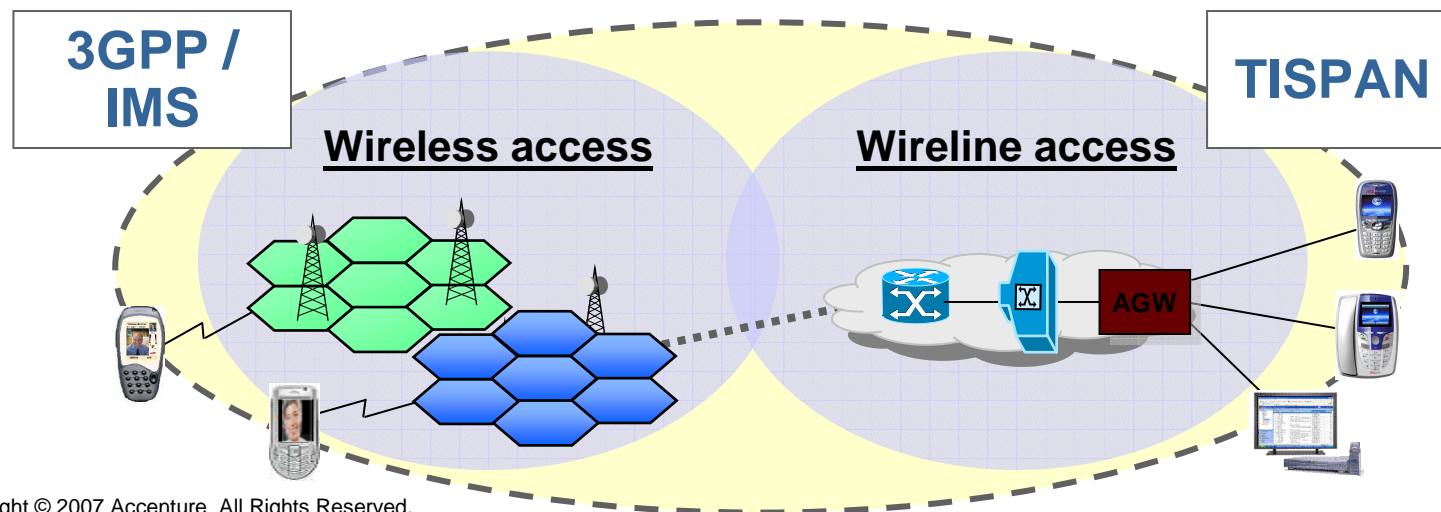

# IMS evolution: NGN Tispan Architecture

*The NGN standard functional architecture, defined by TISPAN, is composed by a “service layer” and a “transport-layer” both based on IP.*

- This subsystem-oriented architecture enables the addition of new subsystems over the time to cover new demands and service classes. The architecture ensures that the network resources, applications, and user equipment are common to all subsystems and therefore ensure user, terminal and service mobility to the fullest extent possible, including across administrative boundaries.

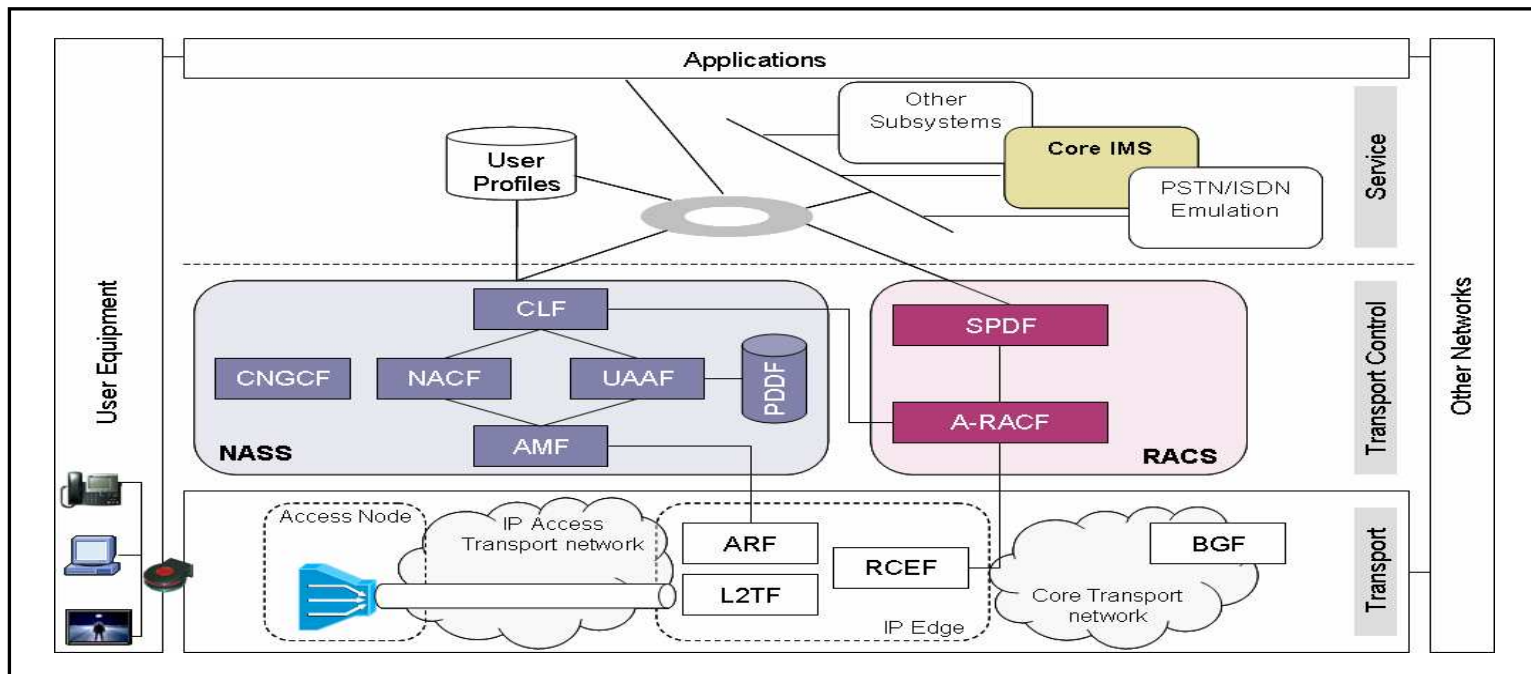

# TISPAN – NGN Functional Architecture (2/2)

▶ *TISPAN NGN solution is based on a subsystem-oriented architecture, enabling the insertion of new subsystems over the time to cover new demands and providing the ability to import/adapt subsystems defined within other standardization bodies.*

## Transport Layer Components

IP Connectivity is provided to the user equipment by the Transport Layer.

The transport layer comprises a transport control sub layer on top of transfer functions.

The transport control sub layer is further divided in two subsystems:

- ❑ Network Attachment Subsystem (**NASS**)
- ❑ the Resource and Admission Control Subsystem (**RACS**).

## Service Layer Components

The service layer comprises:

- ❑ Core IP Multimedia Subsystem (**IMS**)
- ❑ PSTN/ISDN Emulation Subsystem (**PES**)
- ❑ Other subsystems (e.g. streaming subsystem, content broadcasting subsystem etc.) and applications
- ❑ Common components used by several subsystems, such as:
  - charging functions
  - user profile management
  - security management
  - routing data bases (e.g. ENUM)

# NASS – Network Attachment SubSystem

**NASS is a Transport Control layer element defined by ETSI / TISPAN**

**NASS system provides integrated and centralized management of users access to the network**

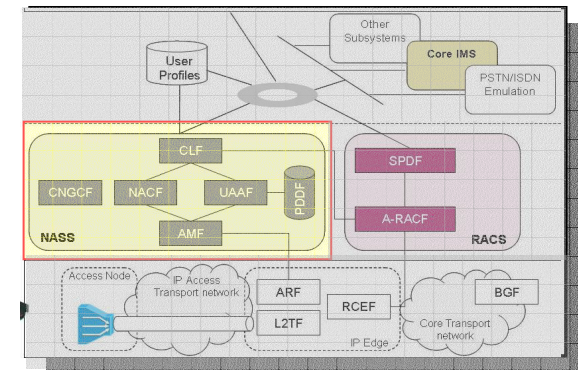

NASS makes possible to expose towards upper-layer systems users presence informations and at the same time apply policies to control network access based on various users profiles

- NASS functionalities cover:
- *Authentication and authorization*
- *Dynamic or static IP address assignment*
- *Access devices configuration*
- *Assignment of the proxy to access to IMS services (i.e. P-CSCF)*
- *Access parameters management (i.e. QoS, bandwidth )*
- *Management of network presence towards application layers*
- *Mobility features*

# RACS (Resource and Admission Control Subsystem)

***RACS is the TISPAN element in the transport control layer responsible of policy control, resource reservation and admission control.***

Racs main functionalities are:

- *Admission Control, which enforce limitations to the access to network resources, e.g. applying bandwidth thresholds*
- *Resource reservation, which enable the reservation, for a given period, of the resources needed to provide a service. For example a voice call will reserve a given bandwidth over the entire circuit before the call is initiated*
- *Policy Control, enable enforcement of policies on the resource exploitation*

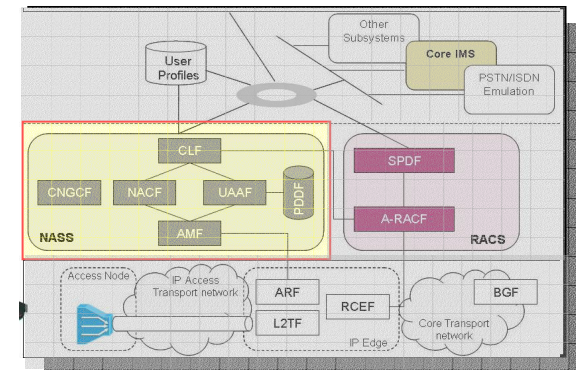



# Agenda

---

- Introduction
- IMS and Telecommunications Operators services
- IMS architecture
- IMS Call Flow
- Developing services within IMS
- IMS evolution: TISPA architecture
- **IMS role in Operators technology roadmaps**

# Service-driven Vs. network-driven NGN approach

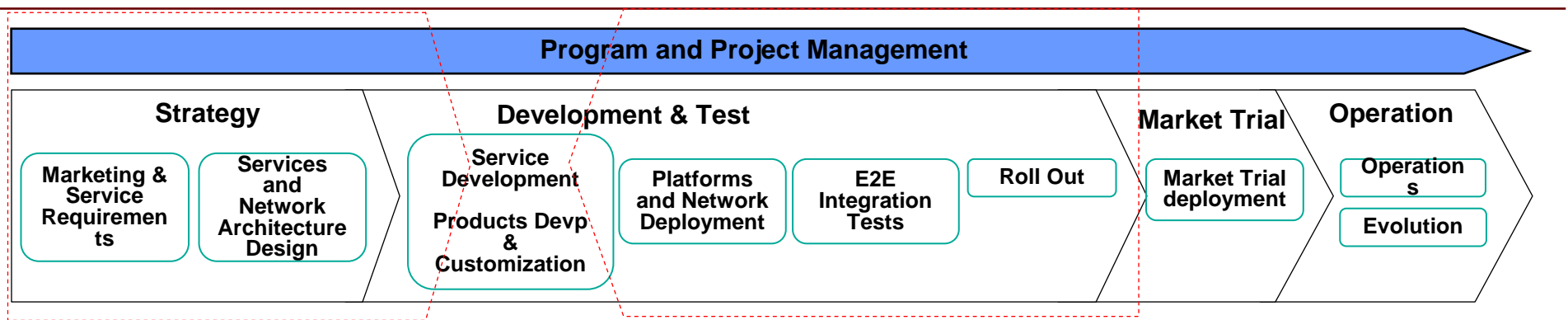

## Service-driven approach

	Pros	Cons
Cost Effectiveness	<ul style="list-style-type: none"> <li>• Incremental Capex due to progressive services Launch</li> </ul>	<ul style="list-style-type: none"> <li>• Develop interfaces between existing and new networks elements (low reusability)</li> </ul>
Operational Excellence	<ul style="list-style-type: none"> <li>• Launch &amp; Tune single "buildings blocks" enabling services due to the faced approach</li> </ul>	<ul style="list-style-type: none"> <li>• Multiple complex network configuration required for an heterogeneous environment</li> </ul>

## Network-driven approach

	Pros	Cons
Cost Effectiveness	<ul style="list-style-type: none"> <li>• Opex decrease due to an integrated and homogeneous environment</li> </ul>	<ul style="list-style-type: none"> <li>• Costly and challenging deployment due to an "in one swoop" overhauled network</li> </ul>
Operational Excellence	<ul style="list-style-type: none"> <li>• Efficient Service Creation and Delivery</li> </ul>	<ul style="list-style-type: none"> <li>• Technologies and standards are evolving, products obsolescence management needed</li> </ul>

# IMS role in Operators technology roadmaps

---

■ **IMS is going to play a key role in Operators technology context for controlling and enabling the introduction of innovative/convergent services in an ALL IP environment**

- ▶ IMS is emerging as the de facto convergence model for fixed, mobile and enterprise telephony. IMS will be used to keep control of the network while using IP technologies: Service and Control Layers will be implemented using IMS architectures as a key: element to **support both IP multimedia sessions over heterogeneous media type.**
- ▶ IMS architecture will be used as “the” mean for obtaining fixed and mobile convergence (3GPP-TISPAN): **different IMSs for mobile and fixed networks will be integrated and merged** into a single infrastructure (e.g. single HSS –Data Base for all users)
- ▶ Innovative and advanced Services (e.g. combinational ones) will leverage **convergent IMS-enabled Service Layer**
- ▶ **IMS alone is not enough**, it will be complemented with additional functional elements such as: external interfaces, databases, enablers (presence, location,...), QoS server, media server, IMS-enabled terminals

# IMS in the existing Provider's service environment is not alone...

*Service interconnections with legacy and consolidated platforms in the short term and with non-IMS platforms will be needed to deliver the integrated experience that users ask for.*

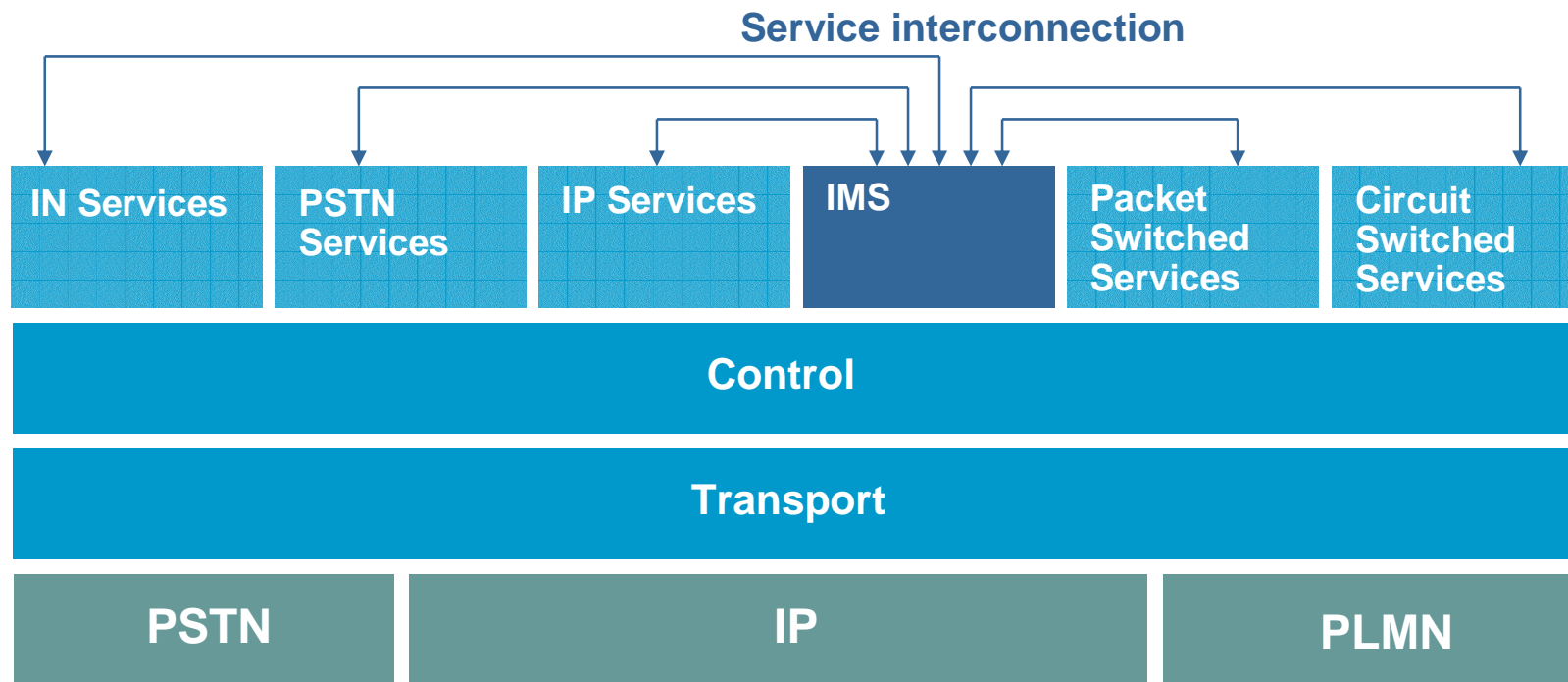

# ...and Service Delivery Platform provides the needed functions to support IMS integration and service creation

