ColdFire® Family Programmer's Reference Manual

Document Number: CFPRM
Rev. 3
03/2005

How to Reach Us:

Home Page:

www.freescale.com

E-mail:

support@freescale.com

USA/Europe or Locations Not Listed:

Freescale Semiconductor
Technical Information Center, CH370
1300 N. Alma School Road
Chandler, Arizona 85224
+1-800-521-6274 or +1-480-768-2130
support@freescale.com

Europe, Middle East, and Africa:

Freescale Halbleiter Deutschland GmbH
Technical Information Center
Schatzbogen 7
81829 Muenchen, Germany
+44 1296 380 456 (English)
+46 8 52200080 (English)
+49 89 92103 559 (German)
+33 1 69 35 48 48 (French)
support@freescale.com

Japan:

Freescale Semiconductor Japan Ltd.
Headquarters
ARCO Tower 15F
1-8-1, Shimo-Meguro, Meguro-ku,
Tokyo 153-0064, Japan
0120 191014 or +81 3 5437 9125
support.japan@freescale.com

Asia/Pacific:

Freescale Semiconductor Hong Kong Ltd.
Technical Information Center
2 Dai King Street
Tai Po Industrial Estate
Tai Po, N.T., Hong Kong
+800 2666 8080
support.asia@freescale.com

For Literature Requests Only:

Freescale Semiconductor Literature Distribution Center
P.O. Box 5405
Denver, Colorado 80217
1-800-441-2447 or 303-675-2140
Fax: 303-675-2150
LDCForFreescaleSemiconductor@hibbertgroup.com

Information in this document is provided solely to enable system and software implementers to use Freescale Semiconductor products. There are no express or implied copyright licenses granted hereunder to design or fabricate any integrated circuits or integrated circuits based on the information in this document.

Freescale Semiconductor reserves the right to make changes without further notice to any products herein. Freescale Semiconductor makes no warranty, representation or guarantee regarding the suitability of its products for any particular purpose, nor does Freescale Semiconductor assume any liability arising out of the application or use of any product or circuit, and specifically disclaims any and all liability, including without limitation consequential or incidental damages. "Typical" parameters that may be provided in Freescale Semiconductor data sheets and/or specifications can and do vary in different applications and actual performance may vary over time. All operating parameters, including "Typicals", must be validated for each customer application by customer's technical experts. Freescale Semiconductor does not convey any license under its patent rights nor the rights of others. Freescale Semiconductor products are not designed, intended, or authorized for use as components in systems intended for surgical implant into the body, or other applications intended to support or sustain life, or for any other application in which the failure of the Freescale Semiconductor product could create a situation where personal injury or death may occur. Should Buyer purchase or use Freescale Semiconductor products for any such unintended or unauthorized application, Buyer shall indemnify and hold Freescale Semiconductor and its officers, employees, subsidiaries, affiliates, and distributors harmless against all claims, costs, damages, and expenses, and reasonable attorney fees arising out of, directly or indirectly, any claim of personal injury or death associated with such unintended or unauthorized use, even if such claim alleges that Freescale Semiconductor was negligent regarding the design or manufacture of the part.



Freescale™ and the Freescale logo are trademarks of Freescale Semiconductor, Inc. All other product or service names are the property of their respective owners. © Freescale Semiconductor, Inc. 2004. All rights reserved.

Document Number: CFPRM
Rev. 3
03/2005

Introduction	1
Addressing Capabilities	2
Instruction Set Summary	3
Integer User Instructions	4
MAC User Instructions	5
EMAC User Instructions	6
FPU User Instructions	7
Supervisor Instructions	8
Instruction Format Summary	9
PST/DDATA Encodings	10
Exception Processing	11
S-Record Output Format	A
Index	IND

1	Introduction
2	Addressing Capabilities
3	Instruction Set Summary
4	Integer User Instructions
5	MAC User Instructions
6	EMAC User Instructions
7	FPU User Instructions
8	Supervisor Instructions
9	Instruction Format Summary
10	PST/DDATA Encodings
11	Exception Processing
A	S-Record Output Format
IND	Index

Contents

Paragraph Number	Title	Page Number
Chapter 1		
Introduction		
1.1	Integer Unit User Programming Model	1-2
1.1.1	Data Registers (D0–D7)	1-2
1.1.2	Address Registers (A0–A7)	1-2
1.1.3	Program Counter (PC)	1-2
1.1.4	Condition Code Register (CCR)	1-2
1.2	Floating-Point Unit User Programming Model	1-3
1.2.1	Floating-Point Data Registers (FP0–FP7)	1-4
1.2.1.1	Floating-Point Control Register (FPCR)	1-4
1.2.2	Floating-Point Status Register (FPSR)	1-5
1.2.3	Floating-Point Instruction Address Register (FPIAR)	1-6
1.3	MAC User Programming Model	1-6
1.3.1	MAC Status Register (MACSR)	1-7
1.3.2	MAC Accumulator (ACC)	1-7
1.3.3	MAC Mask Register (MASK)	1-7
1.4	EMAC User Programming Model	1-8
1.4.1	MAC Status Register (MACSR)	1-8
1.4.2	MAC Accumulators (ACC[0:3])	1-9
1.4.3	Accumulator Extensions (ACCext01, ACCext23)	1-10
1.4.4	MAC Mask Register (MASK)	1-10
1.5	Supervisor Programming Model	1-11
1.5.1	Status Register (SR)	1-12
1.5.2	Supervisor/User Stack Pointers (A7 and OTHER_A7)	1-13
1.5.3	Vector Base Register (VBR)	1-13
1.5.4	Cache Control Register (CACR)	1-13
1.5.5	Address Space Identifier (ASID)	1-13
1.5.6	Access Control Registers (ACR0–ACR3)	1-14
1.5.7	MMU Base Address Register (MMUBAR)	1-14
1.5.8	RAM Base Address Registers (RAMBAR0/RAMBAR1)	1-14
1.5.9	ROM Base Address Registers (ROMBAR0/ROMBAR1)	1-14
1.5.10	Module Base Address Register (MBAR)	1-15
1.6	Integer Data Formats	1-15
1.7	Floating-Point Data Formats	1-16
1.7.1	Floating-Point Data Types	1-16
1.7.1.1	Normalized Numbers	1-16
1.7.1.2	Zeros	1-16
1.7.1.3	Infinities	1-16

Contents

Paragraph Number	Title	Page Number
1.7.1.4	Not-A-Number	1-17
1.7.1.5	Denormalized Numbers	1-17
1.7.2	FPU Data Format and Type Summary	1-17
1.8	Multiply Accumulate Data Formats	1-19
1.9	Organization of Data in Registers	1-19
1.9.1	Organization of Integer Data Formats in Registers	1-19
1.9.2	Organization of Integer Data Formats in Memory	1-20
1.10	Hardware Configuration Information	1-21

Chapter 2 Addressing Capabilities

2.1	Instruction Format	2-1
2.2	Effective Addressing Modes	2-2
2.2.1	Data Register Direct Mode	2-3
2.2.2	Address Register Direct Mode	2-3
2.2.3	Address Register Indirect Mode	2-3
2.2.4	Address Register Indirect with Postincrement Mode	2-4
2.2.5	Address Register Indirect with Predecrement Mode	2-4
2.2.6	Address Register Indirect with Displacement Mode	2-5
2.2.7	Address Register Indirect with Scaled Index and 8-Bit Displacement Mode	2-6
2.2.8	Program Counter Indirect with Displacement Mode	2-6
2.2.9	Program Counter Indirect with Scaled Index and 8-Bit Displacement Mode	2-7
2.2.10	Absolute Short Addressing Mode	2-8
2.2.11	Absolute Long Addressing Mode	2-9
2.2.12	Immediate Data	2-9
2.2.13	Effective Addressing Mode Summary	2-10
2.3	Stack	2-10

Chapter 3 Instruction Set Summary

3.1	Instruction Summary	3-1
3.1.1	Data Movement Instructions	3-4
3.1.2	Program Control Instructions	3-5
3.1.3	Integer Arithmetic Instructions	3-6
3.1.4	Floating-Point Arithmetic Instructions	3-8
3.1.5	Logical Instructions	3-9
3.1.6	Shift Instructions	3-9
3.1.7	Bit Manipulation Instructions	3-10

Contents

Paragraph Number	Title	Page Number
3.1.8	System Control Instructions	3-11
3.1.9	Cache Maintenance Instructions	3-12
3.2	Instruction Set Summary	3-12
3.3	ColdFire Core Summary	3-19

Chapter 4 Integer User Instructions

Chapter 5 Multiply-Accumulate Unit (MAC) User Instructions

Chapter 6 Enhanced Multiply-Accumulate Unit (EMAC) User Instructions

Chapter 7 Floating-Point Unit (FPU) User Instructions

7.1	Floating-Point Status Register (FPSR)	7-1
7.2	Conditional Testing	7-3
7.3	Instruction Results when Exceptions Occur	7-6
7.4	Key Differences between ColdFire and MC680x0 FPU Programming Models	7-7
7.5	Instruction Descriptions	7-9

Chapter 8 Supervisor (Privileged) Instructions

Chapter 9 Instruction Format Summary

9.1	Operation Code Map	9-1
-----	--------------------------	-----

Chapter 10 PST/DDATA Encodings

10.1	User Instruction Set	10-1
10.2	Supervisor Instruction Set	10-7

Contents

Paragraph Number	Title	Page Number
Chapter 11		
Exception Processing		
11.1	Overview	11-1
11.1.1	Supervisor/User Stack Pointers (A7 and OTHER_A7)	11-3
11.1.2	Exception Stack Frame Definition	11-4
11.1.3	Processor Exceptions	11-5
11.1.4	Floating-Point Arithmetic Exceptions	11-5
11.1.5	Branch/Set on Unordered (BSUN)	11-7
11.1.6	Input Not-A-Number (INAN)	11-7
11.1.7	Input Denormalized Number (IDE)	11-8
11.1.8	Operand Error (OPERR)	11-8
11.1.9	Overflow (OVFL)	11-9
11.1.10	Underflow (UNFL)	11-9
11.1.11	Divide-by-Zero (DZ)	11-10
11.1.12	Inexact Result (INEX)	11-10
11.1.13	MMU Changes to the Exception Processing Model	11-11

Appendix A

S-Record Output Format

A.1	S-Record Content 1
A.2	S-Record Types 1
A.3	S-Record Creation 2

Figures

Figure Number	Title	Page Number
1-1	ColdFire Family User Programming Model.....	1-2
1-2	Condition Code Register (CCR).....	1-3
1-3	ColdFire Family Floating-Point Unit User Programming Model.....	1-4
1-4	Floating-Point Control Register (FPCR).....	1-4
1-5	Floating-Point Status Register (FPSR).....	1-5
1-6	MAC Unit Programming Model.....	1-7
1-7	MAC Status Register (MACSR).....	1-7
1-8	EMAC Programming Model.....	1-8
1-9	MAC Status Register (MACSR).....	1-8
1-10	EMAC Fractional Alignment.....	1-9
1-11	EMAC Signed and Unsigned Integer Alignment.....	1-10
1-12	Accumulator 0 and 1 Extensions (ACCext01).....	1-10
1-13	Accumulator 2 and 3 Extensions (ACCext01).....	1-10
1-14	Supervisor Programming Model.....	1-11
1-15	Status Register (SR).....	1-12
1-16	Vector Base Register (VBR).....	1-13
1-17	MMU Base Address Register.....	1-14
1-18	Module Base Address Register (MBAR).....	1-15
1-19	Normalized Number Format.....	1-16
1-20	Zero Format.....	1-16
1-21	Infinity Format.....	1-17
1-22	Not-a-Number Format.....	1-17
1-23	Denormalized Number Format.....	1-17
1-24	Two's Complement, Signed Fractional Equation.....	1-19
1-25	Organization of Integer Data Format in Data Registers.....	1-20
1-26	Organization of Addresses in Address Registers.....	1-20
1-27	Memory Operand Addressing.....	1-21
1-28	Memory Organization for Integer Operands.....	1-21
1-29	D0 Processor Configuration.....	1-22
1-30	D1 Local Memory Configuration.....	1-24
2-1	Instruction Word General Format.....	2-1
2-2	Instruction Word Specification Formats.....	2-2
2-3	Data Register Direct.....	2-3
2-4	Address Register Direct.....	2-3
2-5	Address Register Indirect.....	2-3
2-6	Address Register Indirect with Postincrement.....	2-4
2-7	Address Register Indirect with Predecrement.....	2-5
2-8	Address Register Indirect with Displacement.....	2-5
2-9	Address Register Indirect with Scaled Index and 8-Bit Displacement.....	2-6

Figures

Figure Number	Title	Page Number
2-10	Program Counter Indirect with Displacement	2-7
2-11	Program Counter Indirect with Scaled Index and 8-Bit Displacement	2-8
2-12	Absolute Short Addressing	2-8
2-13	Absolute Long Addressing	2-9
2-14	Immediate Data Addressing.....	2-9
2-15	Stack Growth from High Memory to Low Memory.....	2-11
2-16	Stack Growth from Low Memory to High Memory.....	2-11
7-1	Floating-Point Status Register (FPSR)	7-1
11-1	Exception Stack Frame	11-4

Tables

Table Number	Title	Page Number
1-1	CCR Bit Descriptions	1-3
1-2	FPCR Field Descriptions	1-4
1-3	FPSR Field Descriptions.....	1-5
1-4	MACSR Field Descriptions	1-7
1-5	MACSR Field Descriptions	1-8
1-6	Implemented Supervisor Registers by Device.....	1-11
1-7	Status Field Descriptions	1-12
1-8	MMU Base Address Register Field Descriptions.....	1-14
1-9	MBAR Field Descriptions	1-15
1-10	Integer Data Formats	1-15
1-11	Real Format Summary	1-18
1-12	D0 Processor Configuration Field Descriptions	1-22
1-13	D1 Local Memory Field Descriptions	1-24
2-1	Instruction Word Format Field Definitions	2-2
2-2	Immediate Operand Location	2-9
2-3	Effective Addressing Modes and Categories.....	2-10
3-1	Notational Conventions	3-1
3-2	Data Movement Operation Format	3-4
3-3	Program Control Operation Format	3-5
3-4	Integer Arithmetic Operation Format	3-6
3-5	Dyadic Floating-Point Operation Format	3-8
3-6	Dyadic Floating-Point Operations	3-8
3-7	Monadic Floating-Point Operation Format.....	3-8
3-8	Monadic Floating-Point Operations.....	3-8
3-9	Logical Operation Format.....	3-9
3-10	Shift Operation Format	3-10
3-11	Bit Manipulation Operation Format	3-10
3-12	System Control Operation Format.....	3-11
3-13	Cache Maintenance Operation Format	3-12
3-14	ColdFire User Instruction Set Summary.....	3-13
3-15	ColdFire Supervisor Instruction Set Summary.....	3-18
3-16	ColdFire Instruction Set and Processor Cross-Reference.....	3-19
7-1	FPSR Field Descriptions.....	7-1
7-2	FPSR EXC Bits.....	7-3
7-3	FPCC Encodings.....	7-4
7-4	Floating-Point Conditional Tests	7-5
7-5	FPCR EXC Byte Exception Enabled/Disabled Results.....	7-6
7-6	Key Programming Model Differences.....	7-8
7-7	68K/ColdFire Operation Sequence 1	7-8

Tables

Table Number	Title	Page Number
7-8	68K/ColdFire Operation Sequence 2	7-8
7-9	68K/ColdFire Operation Sequence 3	7-9
7-10	Data Format Encoding	7-10
8-1	State Frames	8-3
8-2	State Frames	8-5
8-3	ColdFire CPU Space Assignments	8-13
9-1	Operation Code Map	9-1
10-1	PST/DDATA Specification for User-Mode Instructions	10-1
10-2	PST/DDATA Values for User-Mode Multiply-Accumulate Instructions	10-5
10-3	PST/DDATA Values for User-Mode Floating-Point Instructions	10-6
10-4	Data Markers and FPU Operand Format Specifiers	10-7
10-5	PST/DDATA Specifications for Supervisor-Mode Instructions	10-7
11-1	Exception Vector Assignments	11-2
11-2	Format/Vector Word	11-4
11-3	Exception Priorities	11-5
11-4	BSUN Exception Enabled/Disabled Results	11-7
11-5	INAN Exception Enabled/Disabled Results	11-7
11-6	IDE Exception Enabled/Disabled Results	11-8
11-7	Possible Operand Errors	11-8
11-8	OPERR Exception Enabled/Disabled Results	11-9
11-9	OVFL Exception Enabled/Disabled Results	11-9
11-10	UNFL Exception Enabled/Disabled Results	11-10
11-11	DZ Exception Enabled/Disabled Results	11-10
11-12	Inexact Rounding Mode Values	11-11
11-13	INEX Exception Enabled/Disabled Results	11-11
11-14	OEP EX Cycle Operations	11-12

Chapter 1

Introduction

This manual contains detailed information about the instruction set architecture (ISA) for all versions of ColdFire® microprocessors. Within the ColdFire Family, each generation of hardware microarchitecture is known as a Version, beginning with the original Version 2 (V2) core implementation, the first native ColdFire processor implementation. Within the instruction set architectures, each definition is known as an ISA_Revision and labeled as ISA_Revision_A, ISA_Revision_B, etc. These ISA revisions are commonly described using a short-form nomenclature as ISA_A, ISA_B, etc.

The original ColdFire ISA was developed from a reduced version of the M68000 instruction set that was targeted to hit a “sweet-spot” representing the minimum of both code expansion (both static and dynamic) and hardware gate count. The original instruction set architecture (the ISA_A specification) supported a proper subset of the M68000 opcodes along with selected enhancements from the M68020, and provided an acceptable trade-off between minimization of code expansion and core gate count, while fully retaining the user-mode programming model from the M68K Family.

As the ColdFire Family grew, input from users and tool developers as well as internal performance analysis suggested a number of ISA enhancements could improve performance and code density. Accordingly, different revisions to the baseline instruction set architecture have been defined and implemented in the various ColdFire processor cores. In addition, optional hardware execution engines targeted for specific application areas required the creation of new ISA extensions. Examples of these extensions are the hardware floating-point unit (FPU) and varieties of multiply-accumulate (MAC) units.

ColdFire legacy had a correspondence between the processor microarchitecture generation and a instruction set architecture revision. As newer instructions have been implemented on earlier core versions, that association has blurred over time. This manual defines the instruction set in terms of the specific ISA revision rather than an association with any given processor version.

The available ISA revisions are:

- ISA_A: The original ColdFire instruction set architecture
- ISA_B: Added improved data movement instructions, byte- and word-sized compares, miscellaneous enhancements
- ISA_C: Added instructions for improved bit manipulation
- FPU: Original ColdFire instruction set architecture for floating-point unit (FPU)
- MAC: Original ColdFire instruction set architecture for multiply-accumulate unit (MAC)
- EMAC: Revised ISA for enhanced multiply-accumulate unit (EMAC)
- EMAC_B: Added instructions for dual-accumulation operations

These represent the major revisions of the instruction set architecture. In addition, there are expanded ISA revisions, e.g., ISA_A+, created by combining a major revision with selected instructions from other revisions.

Information on the processor configuration is generally loaded into 2 program-visible registers at system reset. This information defines the ColdFire core version as well as the implemented ISA revision. See [Section 1.1, “Integer Unit User Programming Model](#).

The ColdFire Family programming model consists of two register groups: user and supervisor. Programs executing in the user mode use only the registers in the user group. System software executing in the supervisor mode can access all registers and use the control registers in the supervisor group to perform supervisor functions. The following paragraphs provide a brief description of the registers in the user and supervisor models as well as the data organization in the registers.

1.1 Integer Unit User Programming Model

Figure 1-1 illustrates the integer portion of the user programming model. It consists of the following registers:

- 16 general-purpose 32-bit registers (D0–D7, A0–A7)
- 32-bit program counter (PC)
- 8-bit condition code register (CCR)

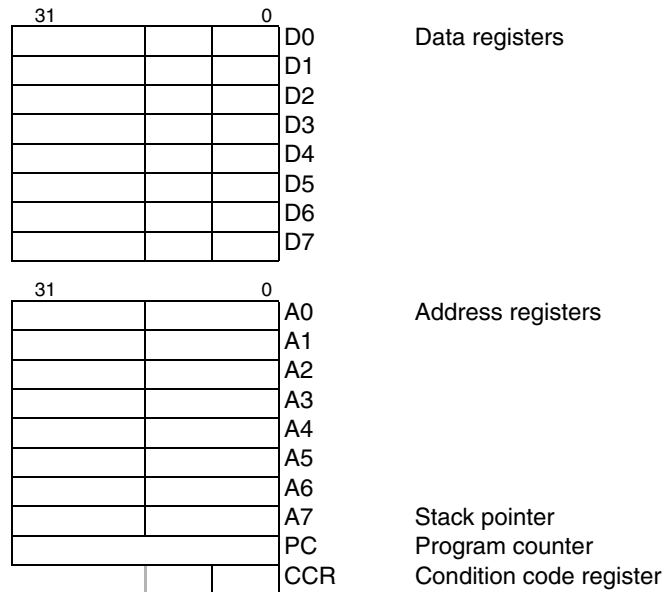

Figure 1-1. ColdFire Family User Programming Model

1.1.1 Data Registers (D0–D7)

These registers are for bit, byte (8 bits), word (16 bits), and longword (32 bits) operations. They can also be used as index registers.

1.1.2 Address Registers (A0–A7)

These registers serve as software stack pointers, index registers, or base address registers. The base address registers can be used for word and longword operations. Register A7 functions as a hardware stack pointer during stacking for subroutine calls and exception handling.

1.1.3 Program Counter (PC)

The program counter (PC) contains the address of the instruction currently executing. During instruction execution and exception processing, the processor automatically increments the contents or places a new value in the PC. For some addressing modes, the PC can serve as a pointer for PC relative addressing.

1.1.4 Condition Code Register (CCR)

Consisting of 5 bits, the condition code register (CCR)—the status register’s lower byte—is the only portion of the SR available in the user mode. Many integer instructions affect the CCR and indicate the

instruction’s result. Program and system control instructions also use certain combinations of these bits to control program and system flow.

The condition codes meet two criteria:

1. Consistency across:
 - Instructions, meaning that all instructions that are special cases of more general instructions affect the condition codes in the same way;
 - Uses, meaning that conditional instructions test the condition codes similarly and provide the same results whether a compare, test, or move instruction sets the condition codes; and
 - Instances, meaning that all instances of an instruction affect the condition codes in the same way.
2. Meaningful results with no change unless it provides useful information.

Bits [3:0] represent a condition of the result generated by an operation. Bit 5, the extend bit, is an operand for multiprecision computations. Version 3 processors have an additional bit in the CCR: bit 7, the branch prediction bit.

The CCR is illustrated in [Figure 1-2](#).

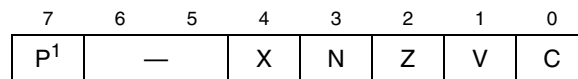

¹The P bit is implemented only on the V3 core.

Figure 1-2. Condition Code Register (CCR)

[Table 1-1](#) describes CCR bits.

Table 1-1. CCR Bit Descriptions

Bits	Field	Description
7	P	Branch prediction (Version 3 only). Alters the static prediction algorithm used by the branch acceleration logic in the instruction fetch pipeline on forward conditional branches. Refer to a V3 core or device user’s manual for further information on this bit.
	—	Reserved; should be cleared (all other versions).
6–5	—	Reserved, should be cleared.
4	X	Extend. Set to the value of the C-bit for arithmetic operations; otherwise not affected or set to a specified result.
3	N	Negative. Set if the most significant bit of the result is set; otherwise cleared.
2	Z	Zero. Set if the result equals zero; otherwise cleared.
1	V	Overflow. Set if an arithmetic overflow occurs implying that the result cannot be represented in the operand size; otherwise cleared.
0	C	Carry. Set if a carry out of the most significant bit of the operand occurs for an addition, or if a borrow occurs in a subtraction; otherwise cleared.

1.2 Floating-Point Unit User Programming Model

The following paragraphs describe the registers for the optional ColdFire floating-point unit. [Figure 1-3](#) illustrates the user programming model for the floating-point unit. It contains the following registers:

- 8 64-bit floating-point data registers (FP0–FP7)
- 32-bit floating-point control register (FPCR)
- 32-bit floating-point status register (FPSR)
- 32-bit floating-point instruction address register (FPIAR)

Figure 1-3. ColdFire Family Floating-Point Unit User Programming Model

1.2.1 Floating-Point Data Registers (FP0–FP7)

Floating-point data registers are analogous to the integer data registers for the 68K/ColdFire family. The 64-bit floating-point data registers always contain numbers in double-precision format. All external operands, regardless of the source data format, are converted to double-precision values before being used in any calculation or being stored in a floating-point data register. A reset or a null-restore operation sets FP0–FP7 to positive, nonsignaling not-a-numbers (NaNs).

1.2.1.1 Floating-Point Control Register (FPCR)

The FPCR, [Figure 1-4](#), contains an exception enable byte (EE) and a mode control byte (MC). The user can read or write to FPCR using FMOVE or FRESTORE. A processor reset or a restore operation of the null state clears the FPCR. When this register is cleared, the FPU never generates exceptions.

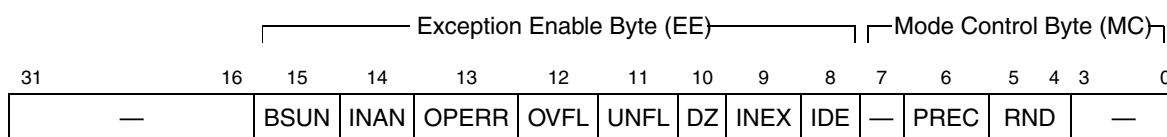

Figure 1-4. Floating-Point Control Register (FPCR)

[Table 1-2](#) describes FPCR fields.

Table 1-2. FPCR Field Descriptions

Bits	Field	Description
31–16	—	Reserved, should be cleared.
15–8	EE	Exception enable byte. Each EE bit corresponds to a floating-point exception class. The user can separately enable traps for each class of floating-point exceptions.
15	BSUN	Branch set on unordered
14	INAN	Input not-a-number
13	OPERR	Operand error
12	OVFL	Overflow
11	UNFL	Underflow
10	DZ	Divide by zero
9	INEX	Inexact operation
8	IDE	Input denormalized

Table 1-2. FPCR Field Descriptions (Continued)

Bits	Field	Description
7–0	MC	Mode control byte. Controls FPU operating modes.
7	—	Reserved, should be cleared.
6	PREC	Rounding precision
5–4	RND	Rounding mode
3–0	—	Reserved, should be cleared.

1.2.2 Floating-Point Status Register (FPSR)

The FPSR, [Figure 1-5](#), contains a floating-point condition code byte (FPCC), a floating-point exception status byte (EXC), and a floating-point accrued exception byte (AEXC). The user can read or write all FPSR bits. Execution of most floating-point instructions modifies FPSR. FPSR is loaded by using FMOVE or FRESTORE. A processor reset or a restore operation of the null state clears the FPSR.

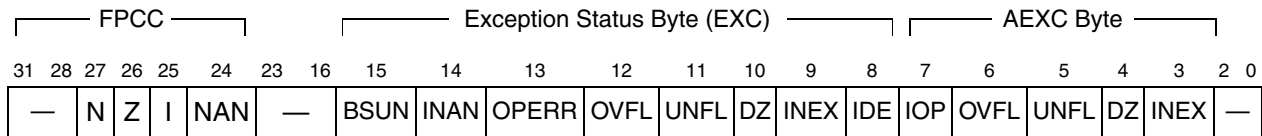

Figure 1-5. Floating-Point Status Register (FPSR)

[Table 1-3](#) describes FPSR fields.

Table 1-3. FPSR Field Descriptions

Bits	Field	Description	
31–24	FPCC	Floating-point condition code byte. Contains four condition code bits that are set after completion of all arithmetic instructions involving the floating-point data registers.	
31–28	—	Reserved, should be cleared.	
27	N	Negative	
26	FPPC (cont.)	Z	Zero
25		I	Infinity
24		NAN	Not-a-number
23–16	—	Reserved, should be cleared.	

Table 1-3. FPSR Field Descriptions (Continued)

Bits	Field	Description	
15–8	EXC	Exception status byte. Contains a bit for each floating-point exception that might have occurred during the most recent arithmetic instruction or move operation.	
15		BSUN	Branch/set on unordered
14		INAN	Input not-a-number
13		OPERR	Operand error
12		OVFL	Overflow
11		UNFL	Underflow
10		DZ	Divide by zero
9		INEX	Inexact operation
8		IDE	Input denormalization
7–0	AEXC	Accrued exception byte. Contains 5 exception bits the IEEE 754 standard requires for exception-disabled operations. These exceptions are logical combinations of bits in the EXC byte. AEXC records all floating-point exceptions since the user last cleared AEXC.	
7		IOP	Invalid operation
6		OVFL	Underflow
5		UNFL	Divide By Zero
4		DZ	Inexact Operation
3		INEX	Input Denormalization
2–0	—	Reserved, should be cleared.	

1.2.3 Floating-Point Instruction Address Register (FPIAR)

The ColdFire operand execution pipeline can execute integer and floating-point instructions simultaneously. As a result, the PC value stacked by the processor in response to a floating-point exception trap may not point to the instruction that caused the exception.

For those FPU instructions that can generate exception traps, the 32-bit FPIAR is loaded with the instruction PC address before the FPU begins execution. In case of an FPU exception, the trap handler can use the FPIAR contents to determine the instruction that generated the exception. FMOVE to/from the FPCR, FPSR, or FPIAR and FMOVEM instructions cannot generate floating-point exceptions and so do not modify FPIAR. A reset or a null-restore operation clears FPIAR.

1.3 MAC User Programming Model

The following paragraphs describe the registers for the optional ColdFire MAC unit. [Figure 1-6](#) illustrates the user programming model for the MAC unit. It contains the following registers:

- 32-bit MAC status register (MACSR)
- 32-bit accumulator register (ACC)
- 32-bit MAC mask register (MASK)

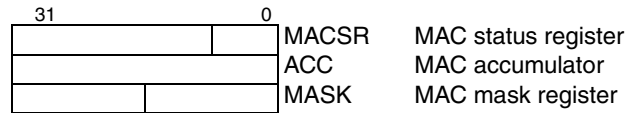

Figure 1-6. MAC Unit Programming Model

1.3.1 MAC Status Register (MACSR)

The MACSR, shown in Figure 1-7, contains an operational mode field and a set of flags.

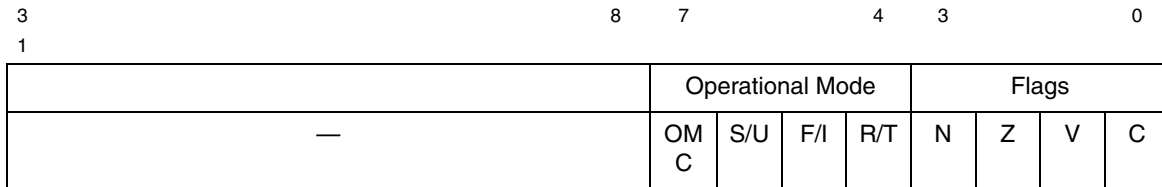

Figure 1-7. MAC Status Register (MACSR)

Table 1-4 describes MACSR fields.

Table 1-4. MACSR Field Descriptions

Bits	Field	Description	
31-8	—	Reserved, should be cleared.	
7-4	OMF	Operational mode field. Defines the operating configuration of the MAC unit.	
7		OMC	Overflow/saturation mode
6		S/U	Signed/unsigned operations
5		F/I	Fraction/integer mode
4		R/T	Round/truncate mode
3-0	Flags	Flags. Contains indicator flags from the last MAC instruction execution.	
3		N	Negative
2		Z	Zero
1		V	Overflow
0		C	Carry. This field is always zero.

1.3.2 MAC Accumulator (ACC)

This 32-bit register contains the results of MAC operations.

1.3.3 MAC Mask Register (MASK)

The mask register (MASK) is 32 bits of which only the low-order 16 bits are implemented. When MASK is loaded, the low-order 16 bits of the source operand are loaded into the register. When it is stored, the upper 16 bits are forced to all ones.

When used by an instruction, this register is ANDed with the specified operand address. Thus, MASK allows an operand address to be effectively constrained within a certain range defined by the 16-bit value. This feature minimizes the addressing support required for filtering, convolution, or any routine that implements a data array as a circular queue using the (Ay)+ addressing mode.

For MAC with load operations, the MASK contents can optionally be included in all memory effective address calculations.

1.4 EMAC User Programming Model

The following paragraphs describe the registers for the optional ColdFire EMAC unit. Figure 1-8 illustrates the user programming model for the EMAC unit. It contains the following registers:

- One 32-bit MAC status register (MACSR) including four indicator bits signaling product or accumulation overflow (one for each accumulator: PAV0–PAV3)
- Four 32-bit accumulators (ACCx = ACC0, ACC1, ACC2, ACC3)
- Eight 8-bit accumulator extensions (two per accumulator), packaged as two 32-bit values for load and store operations (ACCext01, ACCext23)
- One 32-bit mask register (MASK)

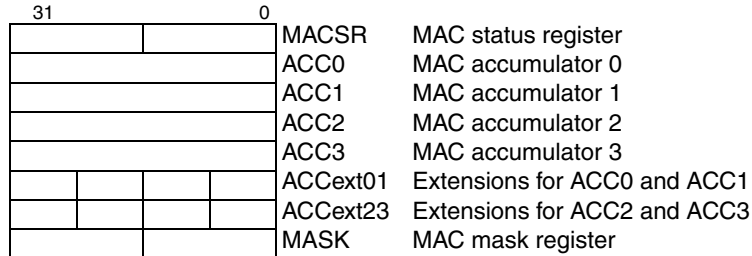

Figure 1-8. EMAC Programming Model

1.4.1 MAC Status Register (MACSR)

Figure 1-9 shows the EMAC MACSR, which contains an operational mode field and two sets of flags.

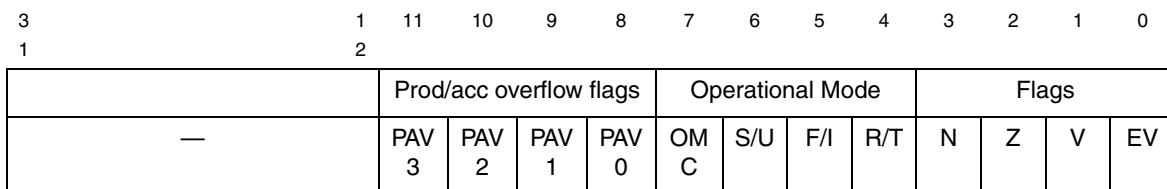

Figure 1-9. MAC Status Register (MACSR)

Table 1-5 describes EMAC MACSR fields.

Table 1-5. MACSR Field Descriptions

Bits	Field	Description
31-12	—	Reserved, should be cleared.
11-8	PAVx	Product/accumulation overflow flags, one per accumulator

Table 1-5. MACSR Field Descriptions (Continued)

Bits	Field	Description	
7-4	OMF	Operational mode field. Defines the operating configuration of the EMAC unit.	
7		OMC	Overflow/saturation mode
6		S/U	Signed/unsigned operations
5		F/I	Fraction/integer mode
4		R/T	Round/truncate mode
3-0	Flags	Flags. Contains indicator flags from the last MAC instruction execution.	
3		N	Negative
2		Z	Zero
1		V	Overflow
0		C	Carry. This field is always zero.

1.4.2 MAC Accumulators (ACC[0:3])

The EMAC implements four 48-bit accumulators. The 32-bit ACCx registers, along with the accumulator extension words, contain the accumulator data. Figure 1-10 shows the data contained by the accumulator and accumulator extension words when the EMAC is operating in fractional mode. The upper 8 bits of the extended product are sign-extended from the 40-bit result taken from the product.

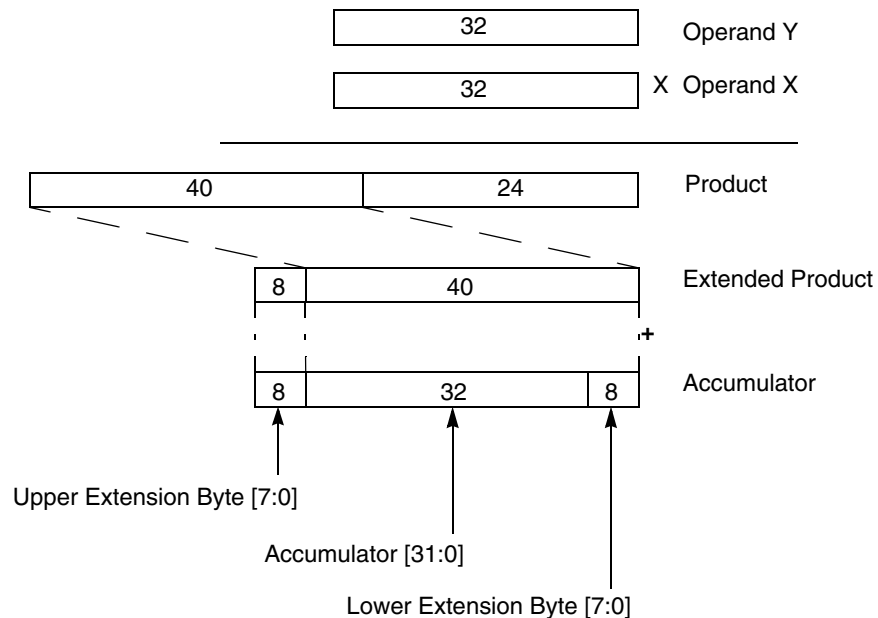

Figure 1-10. EMAC Fractional Alignment

Figure 1-11 shows the data contained by the accumulator and accumulator extension words when the EMAC is operating in signed or unsigned integer mode. In signed mode, the upper 8 bits of the extended product are sign extended from the 40-bit result taken from the product. In unsigned mode, the upper 8 bits of the extended product are all zeros.

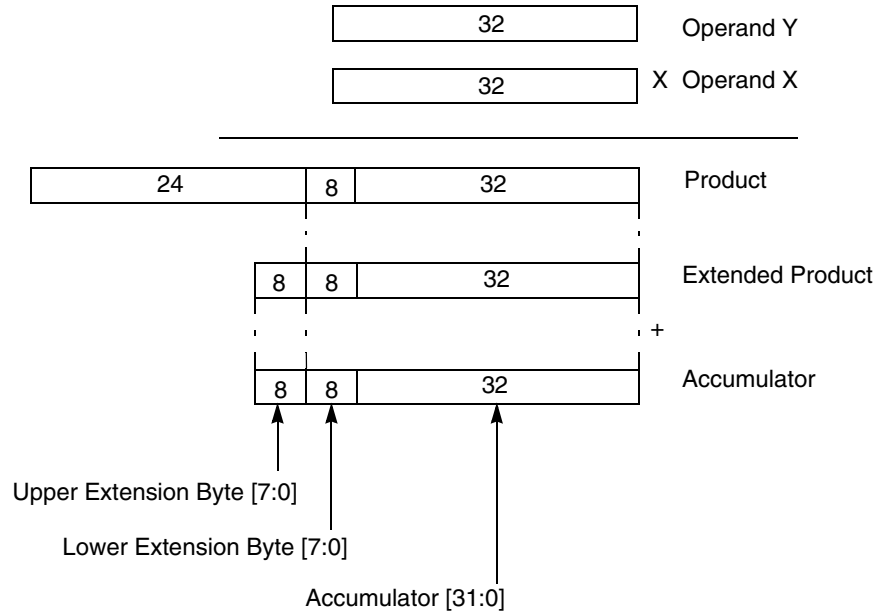

Figure 1-11. EMAC Signed and Unsigned Integer Alignment

1.4.3 Accumulator Extensions (ACCext01, ACCext23)

The 32-bit accumulator extension registers (ACCext01, ACCext23) allow the complete contents of the 48-bit accumulator to be saved and restored on context switches. Figure 1-12 shows how the ACC0 and ACC1 data is stored when loaded into a register. Refer to Figure 1-10 and Figure 1-11 for information on the data contained in the extension bytes.

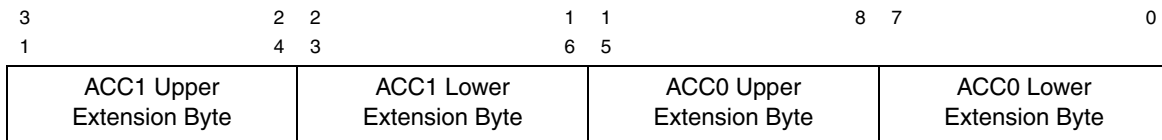

Figure 1-12. Accumulator 0 and 1 Extensions (ACCext01)

Figure 1-13 shows how the ACC2 and ACC3 data is stored when loaded into a register. Refer to Figure 1-10 and Figure 1-11 for information on the data contained in the extension bytes.

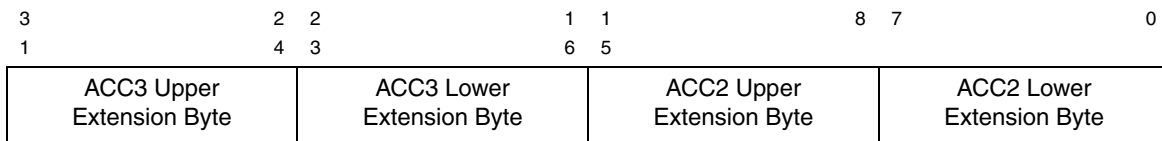

Figure 1-13. Accumulator 2 and 3 Extensions (ACCext01)

1.4.4 MAC Mask Register (MASK)

Only the low-order 16 bits of the 32-bit mask register (MASK) are implemented. When MASK is loaded, the low-order 16 bits of the source operand are loaded into the register. When it is stored, the upper 16 bits are forced to all ones.

When used by an instruction, MASK is ANDed with the specified operand address. Thus, MASK allows an operand address to be effectively constrained within a certain range defined by the 16-bit value. This feature minimizes the addressing support required for filtering, convolution, or any routine that implements a data array as a circular queue using the (Ay)+ addressing mode.

For MAC with load operations, the MASK contents can optionally be included in all memory effective address calculations.

1.5 Supervisor Programming Model

System programmers use the supervisor programming model to implement operating system functions. All accesses that affect the control features of ColdFire processors must be made in supervisor mode. The following paragraphs briefly describe the supervisor registers, which can be accessed only by privileged instructions. The supervisor programming model consists of the registers available to users as well as the registers listed in [Figure 1-14](#).

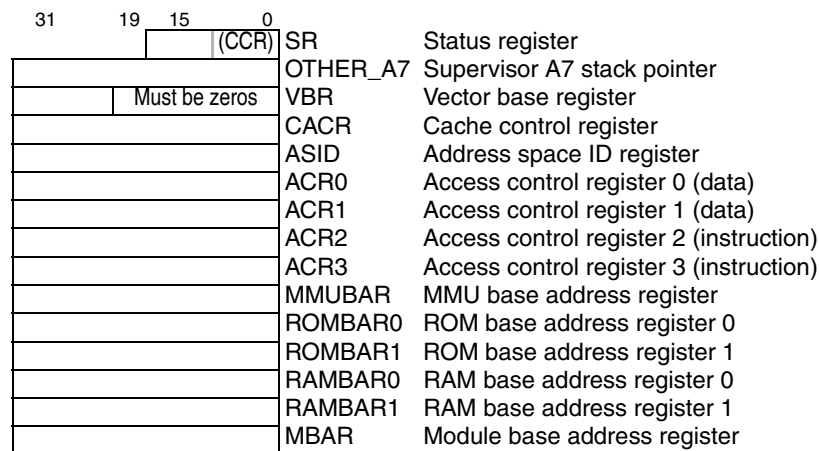

Figure 1-14. Supervisor Programming Model

Note that not all registers are implemented on every ColdFire device; refer to [Table 1-6](#). Future devices may include registers not implemented on earlier devices.

Table 1-6. Implemented Supervisor Registers by Device

Name	V2	V3	V4	V5
SR	x	x	x	x
OTHER_A7	if ISA_A+	if ISA_A+	x	x
VBR	x	x	x	x
CACR	x	x	x	x
ASID			if MMU	if MMU
ACR0	x	x	x	x
ACR1	x	x	x	x
ACR2			x	x
ACR3			x	x
MMUBAR			if MMU	if MMU

Table 1-6. Implemented Supervisor Registers by Device (Continued)

Name	V2	V3	V4	V5
ROMBAR0	DS	DS	DS	DS
ROMBAR1	DS	DS	DS	DS
RAMBAR0	DS	DS	DS	DS
RAMBAR1	DS	DS	DS	DS
MBAR	DS	DS	DS	DS

Note: “x” indicated the supervisor register is implemented. DS indicates the supervisor register is “device-specific”. Please consult the appropriate device reference manual to determine if the register is implemented. Certain supervisor registers are present only if the virtual memory management unit (MMU) is implemented (“if MMU”). Certain supervisor registers are present only if the implemented instruction set architecture is ISA_A+ (“if ISA_A+”).

1.5.1 Status Register (SR)

The SR, shown in [Figure 1-15](#), stores the processor status, the interrupt priority mask, and other control bits. Supervisor software can read or write the entire SR; user software can read or write only SR[7–0], described in [Section 1.1.4, “Condition Code Register \(CCR\).”](#) The control bits indicate processor states: trace mode (T), supervisor or user mode (S), and master or interrupt state (M). SR is set to 0x27xx after reset. The SR register must be explicitly loaded after reset and before any compare, Bcc, or Scc instructions are executed.

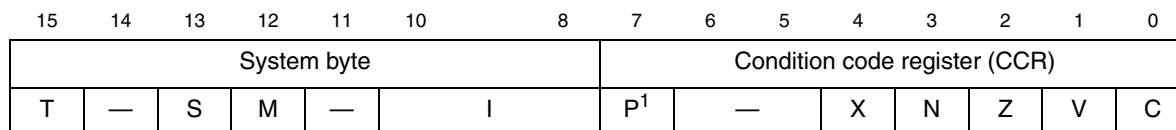

¹The P bit is implemented only on the V3 core.

Figure 1-15. Status Register (SR)

[Table 1-7](#) describes SR fields.

Table 1-7. Status Field Descriptions

Bits	Name	Description
15	T	Trace enable. When T is set, the processor performs a trace exception after every instruction.
14	—	Reserved, should be cleared.
13	S	Supervisor/user state. Indicates whether the processor is in supervisor or user mode
12	M	Master/interrupt state. Cleared by an interrupt exception. It can be set by software during execution of the RTE or move to SR instructions so the OS can emulate an interrupt stack pointer.
11	—	Reserved, should be cleared.
10–8	I	Interrupt priority mask. Defines the current interrupt priority. Interrupt requests are inhibited for all priority levels less than or equal to the current priority, except the edge-sensitive level-7 request, which cannot be masked.
7–0	CCR	Condition code register (see Figure 1-2 and Table 1-1)

1.5.2 Supervisor/User Stack Pointers (A7 and OTHER_A7)

The ISA_A architectures support a single stack pointer (A7). The initial value of A7 is loaded from the reset exception vector, address offset 0.

All remaining ISA revisions support two independent stack pointer (A7) registers: the supervisor stack pointer (SSP) and the user stack pointer (USP). This support provides the required isolation between operating modes (supervisor and user).

The hardware implementation of these two programmable-visible 32-bit registers does not uniquely identify one as the SSP and the other as the USP. Rather, the hardware uses one 32-bit register as the currently active A7 and the other as OTHER_A7. Thus, the register contents are a function of the processor operating mode, as shown in the following:

```

if SR[S] = 1
    then
        A7 = Supervisor Stack Pointer
        other_A7 = User Stack Pointer
    else
        A7 = User Stack Pointer
        other_A7 = Supervisor Stack Pointer

```

1.5.3 Vector Base Register (VBR)

The vector base register contains the 1 MByte-aligned base address of the exception vector table in memory. The displacement of an exception vector adds to the value in this register, which accesses the vector table. VBR[19–0] are filled with zeros.

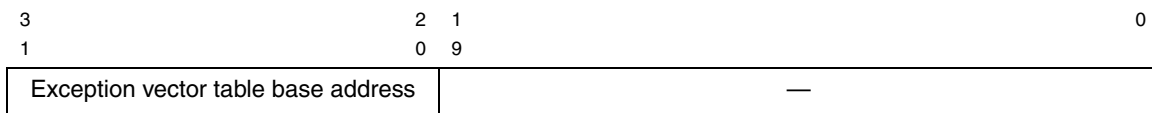

Figure 1-16. Vector Base Register (VBR)

1.5.4 Cache Control Register (CACR)

The CACR controls operation of both the instruction and data cache memory. It includes bits for enabling, locking, and invalidating cache contents. It also includes bits for defining the default cache mode and write-protect fields. Bit functions and positions may vary among ColdFire processor implementations. Refer to a specific device or core user's manual for further information.

1.5.5 Address Space Identifier (ASID)

Only the low-order 8 bits of the 32-bit ASID register are implemented. The ASID value is an 8-bit identifier assigned by the operating system to each process active in the system. It effectively serves as an extension to the 32-bit virtual address. Thus, the virtual reference now becomes a 40-bit value: the 8-bit ASID concatenated with the 32-bit virtual address. ASID is only available if a device has an MMU. Refer to a specific device or core user's manual for further information.

1.5.6 Access Control Registers (ACR0–ACR3)

The access control registers (ACR[0:3]) define attributes for four user-defined memory regions. ACR0 and ACR1 control data memory space and ACR2 and ACR3 control instruction memory space. Attributes include definition of cache mode, write protect, and buffer write enables. Not all ColdFire processors implement all four ACRs. Bit functions and positions may vary among ColdFire processor implementations. Refer to a specific device or core user's manual for further information.

1.5.7 MMU Base Address Register (MMUBAR)

MMUBAR, shown in [Figure 1-17](#), defines a memory-mapped, privileged data-only space with the highest priority in effective address attribute calculation for the data internal memory bus (that is, the MMUBAR has priority over RAMBAR0). If virtual mode is enabled, any normal mode access that does not hit in the MMUBAR, RAMBARs, ROMBARs, or ACRs is considered a normal-mode, virtual address request and generates its access attributes from the MMU. MMUBAR is only available if a device has an MMU. Refer to a specific device or core user's manual for further information.

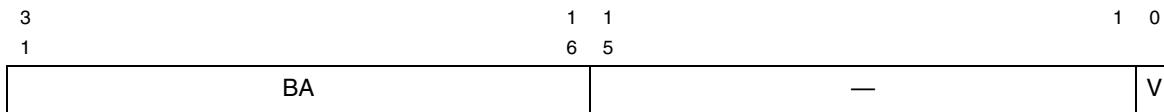

Figure 1-17. MMU Base Address Register

[Table 1-8](#) describes MMU base address register fields.

Table 1-8. MMU Base Address Register Field Descriptions

Bits	Name	Description
31–16	BA	Base address. Defines the base address for the 64-Kbyte address space mapped to the MMU.
15–1	—	Reserved, should be cleared.
0	V	Valid

1.5.8 RAM Base Address Registers (RAMBAR0/RAMBAR1)

RAMBAR registers determine the base address of the internal SRAM modules and indicate the types of references mapped to each. Each RAMBAR includes a base address, write-protect bit, address space mask bits, and an enable bit. RAM base address alignment is implementation specific. A specific ColdFire processor may implement 2, 1, or 0 RAMBARs. Bit functions and positions can vary among ColdFire processor implementations. Refer to a specific device or core user's manual for further information.

1.5.9 ROM Base Address Registers (ROMBAR0/ROMBAR1)

ROMBAR registers determine the base address of the internal ROM modules and indicate the types of references mapped to each. Each ROMBAR includes a base address, write-protect bit, address space mask bits, and an enable bit. ROM base address alignment is implementation specific. A specific ColdFire processor may implement 2, 1, or 0 ROMBARs. Bit functions and positions can vary among ColdFire processor implementations. Refer to a specific device or core user's manual for further information.

1.5.10 Module Base Address Register (MBAR)

The supervisor-level MBAR, [Figure 1-18](#), specifies the base address and allowable access types for all internal peripherals. MBAR can be read or written through the debug module as a read/write register; only the debug module can read MBAR. All internal peripheral registers occupy a single relocatable memory block along 4-Kbyte boundaries. MBAR masks specific address spaces using the address space fields. Refer to a specific device or core user’s manual for further information.

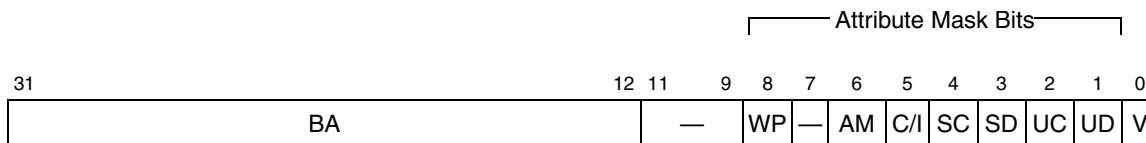

Figure 1-18. Module Base Address Register (MBAR)

[Table 1-9](#) describes MBAR fields.

Table 1-9. MBAR Field Descriptions

Bits	Field	Description
31–12	BA	Base address. Defines the base address for a 4-Kbyte address range.
11–9	—	Reserved, should be cleared.
8–1	AMB	Attribute mask bits
8	WP	Write protect. Mask bit for write cycles in the MBAR-mapped register address range
7	—	Reserved, should be cleared.
6	AM	Alternate master mask
5	C/I	Mask CPU space and interrupt acknowledge cycles
4	SC	Setting masks supervisor code space in MBAR address range
3	SD	Setting masks supervisor data space in MBAR address range
2	UC	Setting masks user code space in MBAR address range
1	UD	Setting masks user data space in MBAR address range
0	V	Valid. Determines whether MBAR settings are valid.

1.6 Integer Data Formats

The operand data formats are supported by the integer unit, as listed in [Table 1-10](#). Integer unit operands can reside in registers, memory, or instructions themselves. The operand size for each instruction is either explicitly encoded in the instruction or implicitly defined by the instruction operation.

Table 1-10. Integer Data Formats

Operand Data Format	Size
Bit	1 bit
Byte integer	8 bits

Table 1-10. Integer Data Formats (Continued)

Operand Data Format	Size
Word integer	16 bits
Longword integer	32 bits

1.7 Floating-Point Data Formats

This section describes the optional FPU's operand data formats. The FPU supports three signed integer formats (byte, word, and longword) that are identical to those supported by the integer unit. The FPU also supports single- and double-precision binary floating-point formats that fully comply with the IEEE-754 standard.

1.7.1 Floating-Point Data Types

Each floating-point data format supports five unique data types: normalized numbers, zeros, infinities, NaNs, and denormalized numbers. The normalized data type, [Figure 1-19](#), never uses the maximum or minimum exponent value for a given format.

1.7.1.1 Normalized Numbers

Normalized numbers include all positive or negative numbers with exponents between the maximum and minimum values. For single- and double-precision normalized numbers, the implied integer bit is one and the exponent can be zero.

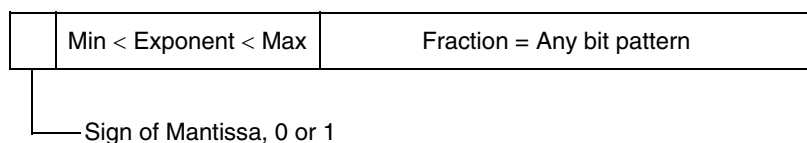

Figure 1-19. Normalized Number Format

1.7.1.2 Zeros

Zeros can be positive or negative and represent real values, + 0.0 and – 0.0. See [Figure 1-20](#).

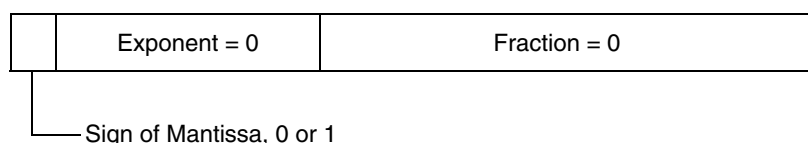

Figure 1-20. Zero Format

1.7.1.3 Infinities

Infinities can be positive or negative and represent real values that exceed the overflow threshold. A result's exponent greater than or equal to the maximum exponent value indicates an overflow for a given data format and operation. This overflow description ignores the effects of rounding and the user-selectable rounding models. For single- and double-precision infinities, the fraction is a zero. See [Figure 1-21](#).

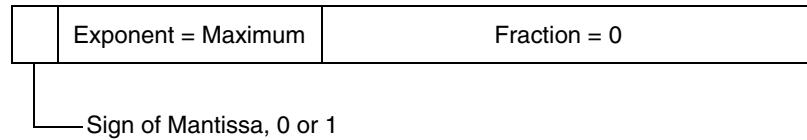

Figure 1-21. Infinity Format

1.7.1.4 Not-A-Number

When created by the FPU, NaNs represent the results of operations having no mathematical interpretation, such as infinity divided by infinity. Operations using a NaN operand as an input return a NaN result. User-created NaNs can protect against uninitialized variables and arrays or can represent user-defined data types. See [Figure 1-22](#).

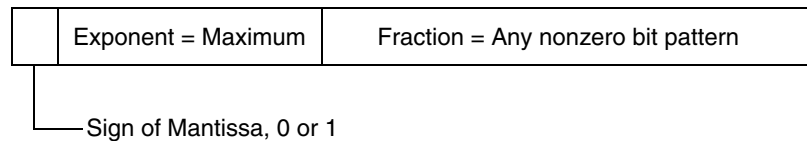

Figure 1-22. Not-a-Number Format

If an input operand to an operation is a NaN, the result is an FPU-created default NaN. When the FPU creates a NaN, the NaN always contains the same bit pattern in the mantissa: all mantissa bits are ones and the sign bit is zero. When the user creates a NaN, any nonzero bit pattern can be stored in the mantissa and the sign bit.

1.7.1.5 Denormalized Numbers

Denormalized numbers represent real values near the underflow threshold. Denormalized numbers can be positive or negative. For denormalized numbers in single- and double-precision, the implied integer bit is a zero. See [Figure 1-23](#).

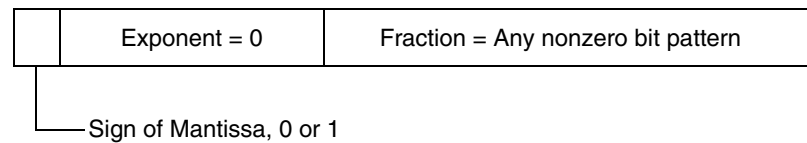

Figure 1-23. Denormalized Number Format

Traditionally, the detection of underflow causes floating-point number systems to perform a flush-to-zero. The IEEE-754 standard implements gradual underflow: the result mantissa is shifted right (denormalized) while the result exponent is incremented until reaching the minimum value. If all the mantissa bits of the result are shifted off to the right during this denormalization, the result becomes zero.

Denormalized numbers are not supported directly in the hardware of this implementation but can be handled in software if needed (software for the input denorm exception could be written to handle denormalized input operands, and software for the underflow exception could create denormalized numbers). If the input denorm exception is disabled, all denormalized numbers are treated as zeros.

1.7.2 FPU Data Format and Type Summary

[Table 1-11](#) summarizes the data type specifications for byte, word, longword, single-, and double-precision data formats.

Table 1-11. Real Format Summary

Parameter	Single-Precision	Double-Precision
Data Format	$\begin{array}{ c c c c } \hline 31 & 30 & 23 & 22 & 0 \\ \hline s & e & & f & \\ \hline \end{array}$	$\begin{array}{ c c c c } \hline 63 & 62 & 52 & 51 & 0 \\ \hline s & e & & f & \\ \hline \end{array}$
Field Size in Bits		
Sign (s)	1	1
Biased exponent (e)	8	11
Fraction (f)	23	52
Total	32	64
Interpretation of Sign		
Positive fraction	s = 0	s = 0
Negative fraction	s = 1	s = 1
Normalized Numbers		
Bias of biased exponent	+127 (0x7F)	+1023 (0x3FF)
Range of biased exponent	$0 < e < 255$ (0xFF)	$0 < e < 2047$ (0x7FF)
Range of fraction	Zero or Nonzero	Zero or Nonzero
Mantissa	1.f	1.f
Relation to representation of real numbers	$(-1)^s \times 2^{e-127} \times 1.f$	$(-1)^s \times 2^{e-1023} \times 1.f$
Denormalized Numbers		
Biased exponent format minimum	0 (0x00)	0 (0x000)
Bias of biased exponent	+126 (0x7E)	+1022 (0x3FE)
Range of fraction	Nonzero	Nonzero
Mantissa	0.f	0.f
Relation to representation of real numbers	$(-1)^s \times 2^{-126} \times 0.f$	$(-1)^s \times 2^{-1022} \times 0.f$
Signed Zeros		
Biased exponent format minimum	0 (0x00)	0 (0x00)
Mantissa	0.f = 0.0	0.f = 0.0
Signed Infinities		
Biased exponent format maximum	255 (0xFF)	2047 (0x7FF)
Mantissa	0.f = 0.0	0.f = 0.0
NANs		
Sign	Don't care	0 or 1

Table 1-11. Real Format Summary (Continued)

Parameter	Single-Precision	Double-Precision
Biased exponent format maximum	255 (0xFF)	255 (0x7FF)
Fraction	Nonzero	Nonzero
Representation of fraction Nonzero bit pattern created by user Fraction when created by FPU	xxxxx...xxxx 11111...1111	xxxxx...xxxx 11111...1111
Approximate Ranges		
Maximum positive normalized	3.4×10^{38}	1.8×10^{308}
Minimum positive normalized	1.2×10^{-38}	2.2×10^{-308}
Minimum positive denormalized	1.4×10^{-45}	4.9×10^{-324}

1.8 Multiply Accumulate Data Formats

The MAC and EMAC units support 16- or 32-bit input operands of the following formats:

- Two's complement signed integers: In this format, an N-bit operand value lies in the range $-2^{(N-1)} \leq \text{operand} \leq 2^{(N-1)} - 1$. The binary point is right of the lsb.
- Unsigned integers: In this format, an N-bit operand value lies in the range $0 \leq \text{operand} \leq 2^N - 1$. The binary point is right of the lsb.
- Two's complement, signed fractionals: In an N-bit number, the first bit is the sign bit. The remaining bits signify the first N-1 bits after the binary point. Given an N-bit number, $a_{N-1}a_{N-2}a_{N-3}\dots a_2a_1a_0$, its value is given by the equation in Figure 1-24.

$$\text{value} = -(1 \cdot a_{N-1}) + \sum_{i=0}^{N-2} 2^{(i+1-N)} \cdot a_i$$

Figure 1-24. Two's Complement, Signed Fractional Equation

This format can represent numbers in the range $-1 \leq \text{operand} \leq 1 - 2^{(N-1)}$.

For words and longwords, the largest negative number that can be represented is -1, whose internal representation is 0x8000_0000 and 0x8000_0000, respectively. The largest positive word is 0x7FFF or $(1 - 2^{-15})$; the most positive longword is 0x7FFF_FFFF or $(1 - 2^{-31})$.

1.9 Organization of Data in Registers

This section describes data organization within the data, address, and control registers.

1.9.1 Organization of Integer Data Formats in Registers

Each integer data register is 32 bits wide. Byte and word operands occupy the lower 8- and 16-bit portions of integer data registers, respectively. Longword operands occupy entire data registers. A data register that is either a source or destination operand only uses or changes the appropriate lower 8 or 16 bits (in byte or word operations, respectively). The remaining high-order portion does not change and is unused and

unchanged. The address of the least significant bit (lsb) of a longword integer is zero, and the most significant bit (msb) is 31. [Figure 1-25](#) illustrates the organization of integer data in data registers.

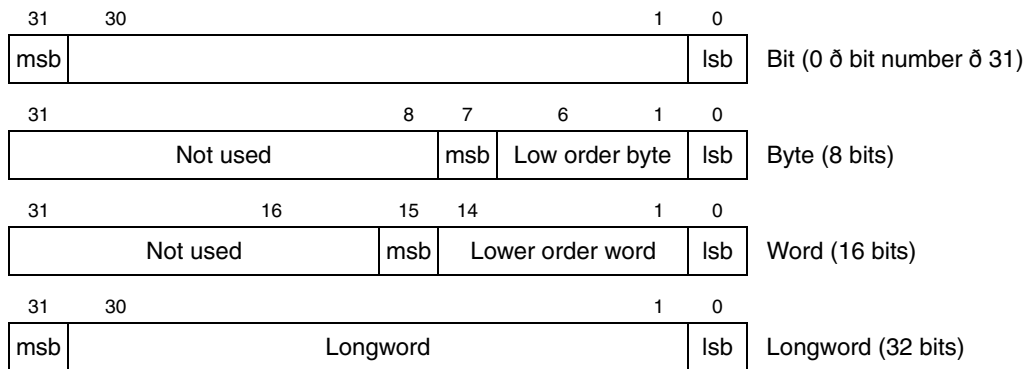

Figure 1-25. Organization of Integer Data Format in Data Registers

Because address registers and stack pointers are 32 bits wide, address registers cannot be used for byte-size operands. When an address register is a source operand, either the low-order word or the entire longword operand is used, depending on the operation size. When an address register is the destination operand, the entire register becomes affected, despite the operation size. If the source operand is a word size, it is sign-extended to 32 bits and then used in the operation to an address-register destination. Address registers are primarily for addresses and address computation support. The instruction set explains how to add to, compare, and move the contents of address registers. [Figure 1-26](#) illustrates the organization of addresses in address registers.

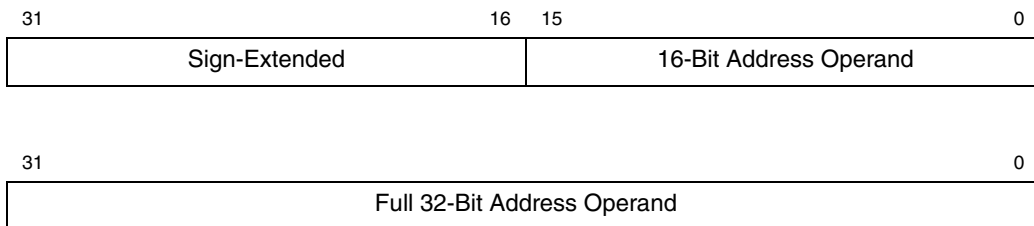

Figure 1-26. Organization of Addresses in Address Registers

Control registers vary in size according to function. Some control registers have undefined bits reserved for future definition by Freescale. Those particular bits read as zeros and must be written as zeros for future compatibility.

All operations to the SR and CCR are word-size operations. For all CCR operations, the upper byte is read as all zeros and is ignored when written, despite privilege mode. The write-only MOVEC instruction writes to the system control registers (VBR, CACR, etc.).

1.9.2 Organization of Integer Data Formats in Memory

The byte-addressable organization of memory allows lower addresses to correspond to higher order bytes. The address N of a longword data item corresponds to the address of the MSB of the highest order word. The lower order word is located at address $N + 2$, leaving the LSB at address $N + 3$ (see [Figure 1-27](#)). The lowest address (nearest $0x00000000$) is the location of the MSB, with each successive LSB located at the next address ($N + 1$, $N + 2$, etc.). The highest address (nearest $0xFFFFFFFF$) is the location of the LSB.

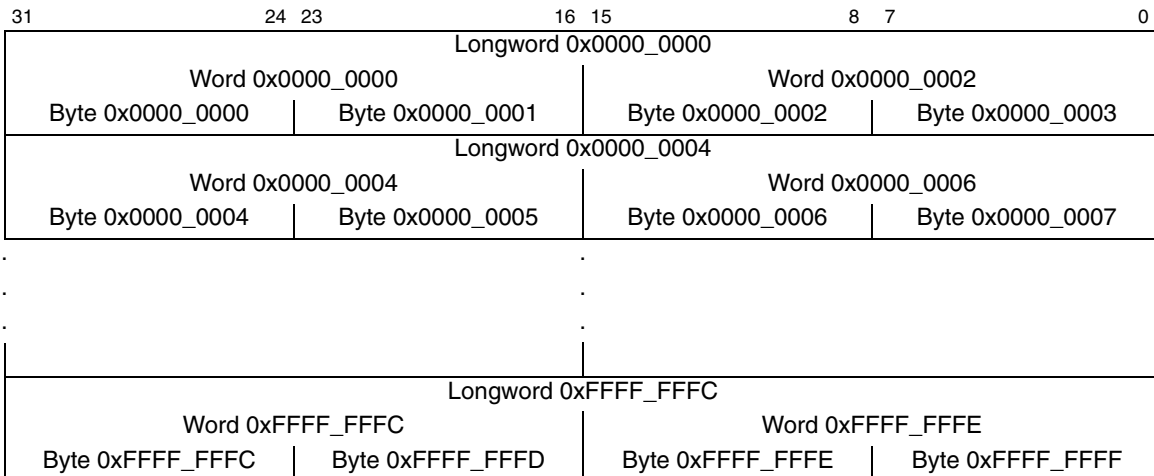

Figure 1-27. Memory Operand Addressing

Figure 1-28 illustrates the organization of data formats in memory. A base address that selects one byte in memory—the base byte—specifies a bit number that selects one bit, the bit operand, in the base byte. The msb of the byte is 7.

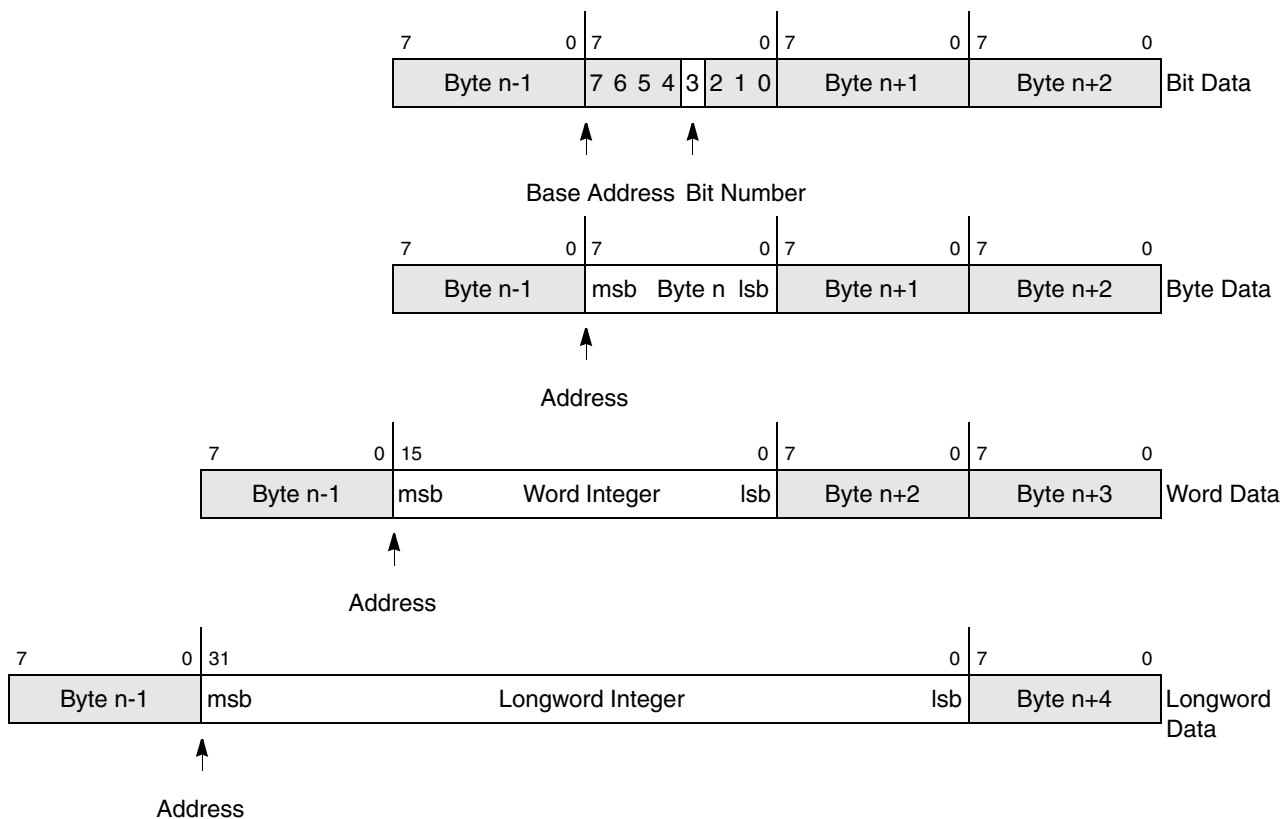

Figure 1-28. Memory Organization for Integer Operands

1.10 Hardware Configuration Information

ColdFire hardware configuration information is loaded into the D0 and D1 general-purpose registers after

system reset. The hardware configuration information is loaded immediately after the reset-in signal is negated, as this allows an emulator to read out the contents of these registers via BDM and determine the hardware configuration. This functionality was not supported in the earliest V2 and V3 implementations, but has since been included in all ColdFire cores. The contents of the D0 register provide the processor configuration and the contents of the D1 register provide information on the local memory configuration. These two registers are generally stored into memory at the very beginning of reset exception processing so the processor configuration can subsequently be examined.

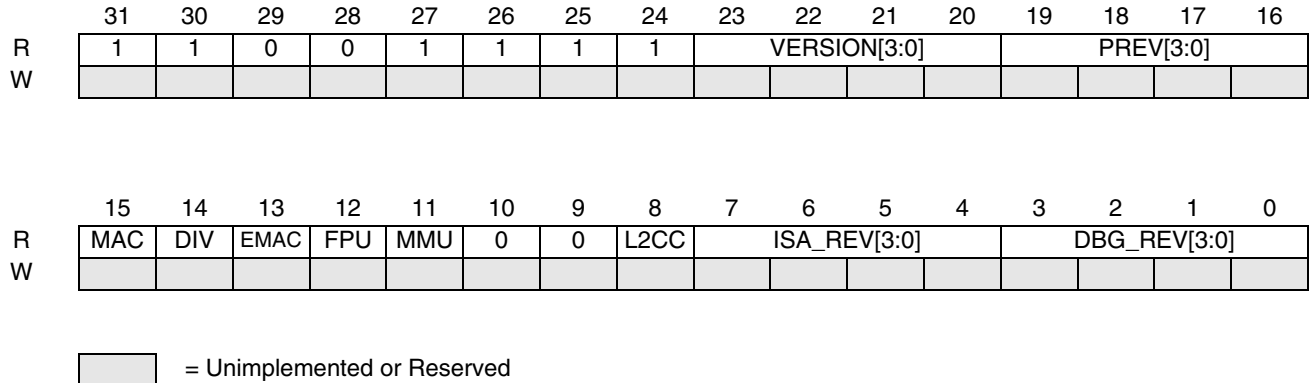

Figure 1-29. D0 Processor Configuration

Table 1-12. D0 Processor Configuration Field Descriptions

Name	Description	Value
VERSION [3:0]	Core Version	This 4-bit field defines the hardware microarchitecture (version) of the ColdFire core. if Version = 0b0010, then Version 2 ColdFire if Version = 0b0011, then Version 3 ColdFire if Version = 0b0100, then Version 4 ColdFire if Version = 0b0101, then Version 5 ColdFire All other values are reserved for future use. The upper 12 bits of the D0 reset value directly identify the ColdFire core version, e.g., "CF2" for a Version 2 core, "CF3" for a Version 3 core, etc.
PREV [3:0]	Processor Revision	This 4-bit field defines processor hardware revision number. The default is 0b0000.
MAC	MAC Present	This bit signals if the optional multiply-accumulate (MAC) execution engine is present in the processor core. 0 = MAC not present 1 = MAC present If an EMAC is present, this bit is cleared.

Table 1-12. D0 Processor Configuration Field Descriptions (Continued)

Name	Description	Value
DIV	Divider Present	This bit signals if the hardware divider (DIV) is present in the processor core. Certain early V2 core implementations, e.g., MCF5202, MCF5204, MCF5206, did not include hardware support for integer divide operations. 0 = DIV not present 1 = DIV present
EMAC	EMAC Present	This bit signals if the optional enhanced multiply-accumulate (EMAC) execution engine is present in the processor core. 0 = EMAC not present 1 = EMAC present If a MAC is present, this bit is cleared.
FPU	FPU Present	This bit signals if the optional floating-point (FPU) execution engine is present in the processor core. 0 = FPU not present 1 = FPU present
MMU	MMU Present	This bit signals if the optional virtual memory management unit is present in the processor core. 0 = MMU not present 1 = MMU present
L2CC	Level 2 Cache Controller Present	This bit signals if the optional Level 2 Cache Controller and attached memory is present in the processor core. 0 = L2CC not present 1 = L2CC present
ISA_REV [3:0]	ISA Revision	This 4-bit field defines the instruction set architecture revision level implemented in the ColdFire processor core. if ISA_REV = 0b0000, then ISA_A if ISA_REV = 0b1000, then ISA_A+ if ISA_REV = 0b0001, then ISA_B if ISA_REV = 0b0010, then ISA_C All other values are reserved for future use.
DBG_REV [3:0]	Debug Module Revision	This 4-bit field defines the revision level of the debug module implemented in the ColdFire processor core. if DBG_REV = 0b0000, then Debug_A if DBG_REV = 0b1000, then Debug_A+ if DBG_REV = 0b0001, then Debug_B if DBG_REV = 0b1001, then Debug_B+ if DBG_REV = 0b0010, then Debug_C if DBG_REV = 0b0011, then Debug_D if DBG_REV = 0b0100, then Debug_E All other values are reserved for future use.

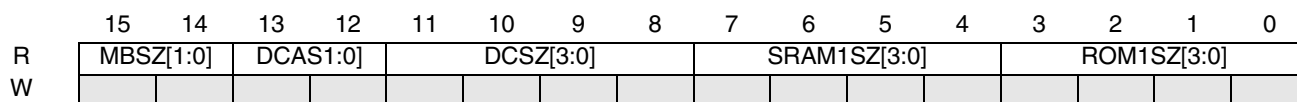
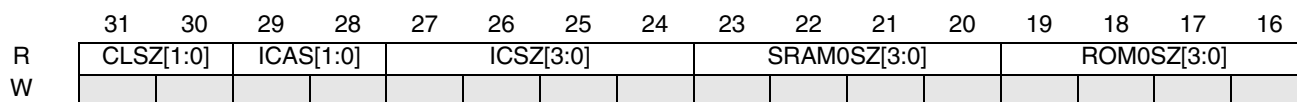

 = Unimplemented or Reserved

Figure 1-30. D1 Local Memory Configuration

Table 1-13. D1 Local Memory Field Descriptions

Name	Description	Value
CLSZ[1:0]	Cache Line Size	This 2-bit field defines the cache line size. if CLSZ = 0b00, then 16-byte cache line size if CLSZ = 0b01, then 32-byte cache line size All other values are reserved for future use.
ICAS[1:0]	I-Cache Associativity	This 2-bit field defines the I-Cache set-associativity. if ICAS = 0b00, then I-Cache is 4-way set-associative organization if ICAS = 0b01, then I-Cache is direct-mapped organization All other values are reserved for future use.
ICSZ[3:0]	I-Cache Size	This 4-bit field defines the I-Cache size. if ICSZ = 0b0000, then no I-Cache if ICSZ = 0b0001, then I-Cache size is 512 bytes if ICSZ = 0b0010, then I-Cache size is 1 Kbytes if ICSZ = 0b0011, then I-Cache size is 2 Kbytes if ICSZ = 0b0100, then I-Cache size is 4 Kbytes if ICSZ = 0b0101, then I-Cache size is 8 Kbytes if ICSZ = 0b0110, then I-Cache size is 16 Kbytes if ICSZ = 0b0111, then I-Cache size is 32 Kbytes if ICSZ = 0b1000, then I-Cache size is 64 Kbytes All other values are reserved for future use.

Table 1-13. D1 Local Memory Field Descriptions (Continued)

Name	Description	Value
SRAM0SZ [3:0]	SRAM0 Size	<p>This 4-bit field defines the SRAM0 size.</p> <p>if SRAM0SZ = 0b0000, then no SRAM0</p> <p>if SRAM0SZ = 0b0001, then SRAM0 size is 512 bytes</p> <p>if SRAM0SZ = 0b0010, then SRAM0 size is 1 Kbytes</p> <p>if SRAM0SZ = 0b0011, then SRAM0 size is 2 Kbytes</p> <p>if SRAM0SZ = 0b0100, then SRAM0 size is 4 Kbytes</p> <p>if SRAM0SZ = 0b0101, then SRAM0 size is 8 Kbytes</p> <p>if SRAM0SZ = 0b0110, then SRAM0 size is 16 Kbytes</p> <p>if SRAM0SZ = 0b0111, then SRAM0 size is 32 Kbytes</p> <p>if SRAM0SZ = 0b1000, then SRAM0 size is 64 Kbytes</p> <p>if SRAM0SZ = 0b1001, then SRAM0 size is 128 Kbytes</p> <p>All other values are reserved for future use.</p>
ROM0SZ [3:0]	ROM0 Size	<p>This 4-bit field defines the ROM0 size.</p> <p>if ROM0SZ = 0b0000, then no ROM0</p> <p>if ROM0SZ = 0b0001, then ROM0 size is 512 bytes</p> <p>if ROM0SZ = 0b0010, then ROM0 size is 1 Kbytes</p> <p>if ROM0SZ = 0b0011, then ROM0 size is 2 Kbytes</p> <p>if ROM0SZ = 0b0100, then ROM0 size is 4 Kbytes</p> <p>if ROM0SZ = 0b0101, then ROM0 size is 8 Kbytes</p> <p>if ROM0SZ = 0b0110, then ROM0 size is 16 Kbytes</p> <p>if ROM0SZ = 0b0111, then ROM0 size is 32 Kbytes</p> <p>if ROM0SZ = 0b1000, then ROM0 size is 64 Kbytes</p> <p>if ROM0SZ = 0b1001, then ROM0 size is 128 Kbytes</p> <p>All other values are reserved for future use.</p>
MBSZ[1:0]	Mbus Size	<p>This 2-bit field defines the width of the ColdFire Master Bus datapath.</p> <p>if MBSZ = 0b00, then 32-bit system bus datapath</p> <p>if MBSZ = 0b01, then 64-bit system bus datapath</p> <p>All other values are reserved for future use.</p>
DCAS[1:0]	D-Cache Associativity	<p>This 2-bit field defines the D-Cache set-associativity.</p> <p>if DCAS = 0b00, then D-Cache is 4-way set-associative organization</p> <p>if DCAS = 0b01, then D-Cache is direct-mapped organization</p> <p>All other values are reserved for future use.</p>

Table 1-13. D1 Local Memory Field Descriptions (Continued)

Name	Description	Value
DCSZ[3:0]	D-Cache Size	<p>This 4-bit field defines the D-Cache size.</p> <p>if DCSZ = 0b0000, then no D-Cache</p> <p>if DCSZ = 0b0001, then D-Cache size is 512 bytes</p> <p>if DCSZ = 0b0010, then D-Cache size is 1 Kbytes</p> <p>if DCSZ = 0b0011, then D-Cache size is 2 Kbytes</p> <p>if DCSZ = 0b0100, then D-Cache size is 4 Kbytes</p> <p>if DCSZ = 0b0101, then D-Cache size is 8 Kbytes</p> <p>if DCSZ = 0b0110, then D-Cache size is 16 Kbytes</p> <p>if DCSZ = 0b0111, then D-Cache size is 32 Kbytes</p> <p>if DCSZ = 0b1000, then D-Cache size is 64 Kbytes</p> <p>All other values are reserved for future use.</p>
SRAM1SZ [3:0]	SRAM1 Size	<p>This 4-bit field defines the SRAM1 size.</p> <p>if SRAM1SZ = 0b0000, then no SRAM1</p> <p>if SRAM1SZ = 0b0001, then SRAM1 size is 512 bytes</p> <p>if SRAM1SZ = 0b0010, then SRAM1 size is 1 Kbytes</p> <p>if SRAM1SZ = 0b0011, then SRAM1 size is 2 Kbytes</p> <p>if SRAM1SZ = 0b0100, then SRAM1 size is 4 Kbytes</p> <p>if SRAM1SZ = 0b0101, then SRAM1 size is 8 Kbytes</p> <p>if SRAM1SZ = 0b0110, then SRAM1 size is 16 Kbytes</p> <p>if SRAM1SZ = 0b0111, then SRAM1 size is 32 Kbytes</p> <p>if SRAM1SZ = 0b1000, then SRAM1 size is 64 Kbytes</p> <p>if SRAM1SZ = 0b1001, then SRAM1 size is 128 Kbytes</p> <p>All other values are reserved for future use.</p>
ROM1SZ [3:0]	ROM1 Size	<p>This 4-bit field defines the ROM1 size.</p> <p>if ROM1SZ = 0b0000, then no ROM1</p> <p>if ROM1SZ = 0b0001, then ROM1 size is 512 bytes</p> <p>if ROM1SZ = 0b0010, then ROM1 size is 1 Kbytes</p> <p>if ROM1SZ = 0b0011, then ROM1 size is 2 Kbytes</p> <p>if ROM1SZ = 0b0100, then ROM1 size is 4 Kbytes</p> <p>if ROM1SZ = 0b0101, then ROM1 size is 8 Kbytes</p> <p>if ROM1SZ = 0b0110, then ROM1 size is 16 Kbytes</p> <p>if ROM1SZ = 0b0111, then ROM1 size is 32 Kbytes</p> <p>if ROM1SZ = 0b1000, then ROM1 size is 64 Kbytes</p> <p>if ROM1SZ = 0b1001, then ROM1 size is 128 Kbytes</p> <p>All other values are reserved for future use.</p>

Note if the processor core implementation includes a Level 2 cache, the memory capacity is available by reading the L2_CACR (Level 2 Cache Control Register).

Revision History

Content Changes by Document Version

Version No. Release Date	Description of Changes	Page Numbers
Rev 3 7-mar-05	General release: each chapter received edits identifying instructions by ISA_x architecture rather than V2, V3, V4 and V5 (previously depicting “ColdFire, version 2”, etc). Correction to ISA_x is due to advanced instructions now back-annotated into all versions of ColdFire cores.	Entire book



THIS PAGE INTENTIONALLY LEFT BLANK

Chapter 2

Addressing Capabilities

Most operations compute a source operand and destination operand and store the result in the destination location. Single-operand operations compute a destination operand and store the result in the destination location. External microprocessor references to memory are either program references that refer to program space or data references that refer to data space. They access either instruction words or operands (data items) for an instruction. Program space is the section of memory that contains the program instructions and any immediate data operands residing in the instruction stream. Data space is the section of memory that contains the program data. The program-counter relative addressing modes can be classified as data references.

2.1 Instruction Format

ColdFire Family instructions consist of 1 to 3 words. [Figure 2-1](#) illustrates the general composition of an instruction. The first word of the instruction, called the operation word or opword, specifies the length of the instruction, the effective addressing mode, and the operation to be performed. The remaining words further specify the instruction and operands. These words can be conditional predicates, immediate operands, extensions to the effective addressing mode specified in the operation word, branch displacements, bit number or special register specifications, trap operands, argument counts, or floating-point command words. The ColdFire architecture instruction word length is limited to 3 sizes: 16, 32, or 48 bits.

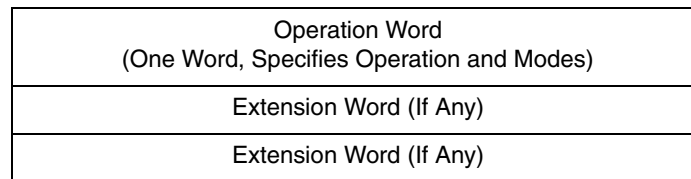

Figure 2-1. Instruction Word General Format

An instruction specifies the function to be performed with an operation code and defines the location of every operand. The operation word format is the basic instruction word (see [Figure 2-2](#)). The encoding of the mode field selects the addressing mode. The register field contains the general register number or a value that selects the addressing mode when the mode field = 111. Some indexed or indirect addressing modes use a combination of the operation word followed by an extension word. [Figure 2-2](#) illustrates two formats used in an instruction word; [Table 2-1](#) lists the field definitions.

Operation Word Format

15	14	13	12	11	10	9	8	7	6	5	4	3	2	1	0
X	X	X	X	X	X	X	X	X	X	Effective Address					
										Mode		Register			

Extension Word Format

15	14	13	12	11	10	9	8	7	6	5	4	3	2	1	0
D/A	Register			W/L	Scale		0	Displacement							

Figure 2-2. Instruction Word Specification Formats

Table 2-1 defines instruction word formats.

Table 2-1. Instruction Word Format Field Definitions

Field	Definition
Instruction	
Mode	Addressing mode (see Table 2-3)
Register	General register number (see Table 2-3)
Extensions	
D/A	Index register type 0 = Dn 1 = An
W/L	Word/longword index size 0 = Address Error Exception 1 = Longword
Scale	Scale factor 00 = 1 01 = 2 10 = 4 11 = 8 (supported only if FPU is present)

2.2 Effective Addressing Modes

Besides the operation code that specifies the function to be performed, an instruction defines the location of every operand for the function. Instructions specify an operand location in one of the three following ways:

- A register field within an instruction can specify the register to be used.
- An instruction's effective address field can contain addressing mode information.
- The instruction's definition can imply the use of a specific register. Other fields within the instruction specify whether the register selected is an address or data register and how the register is to be used.

An instruction's addressing mode specifies the value of an operand, a register that contains the operand, or how to derive the effective address of an operand in memory. Each addressing mode has an assembler

syntax. Some instructions imply the addressing mode for an operand. These instructions include the appropriate fields for operands that use only one addressing mode.

2.2.1 Data Register Direct Mode

In the data register direct mode, the effective address field specifies the data register containing the operand.

Generation	EA = Dn
Assembler Syntax	Dn
EA Mode Field	000
EA Register Field	Register number
Number of Extension Words	0

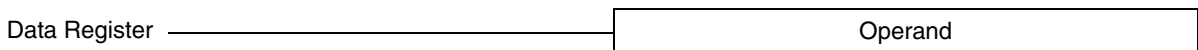

Figure 2-3. Data Register Direct

2.2.2 Address Register Direct Mode

In the address register direct mode, the effective address field specifies the address register containing the operand.

Generation	EA = An
Assembler Syntax	An
EA Mode Field	001
EA Register Field	Register number
Number of Extension Words	0

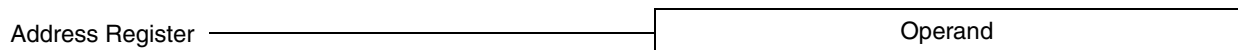

Figure 2-4. Address Register Direct

2.2.3 Address Register Indirect Mode

In the address register indirect mode, the operand is in memory. The effective address field specifies the address register containing the address of the operand in memory.

Generation	EA = (An)
Assembler Syntax	(An)
EA Mode Field	010
EA Register Field	Register number
Number of Extension Words	0

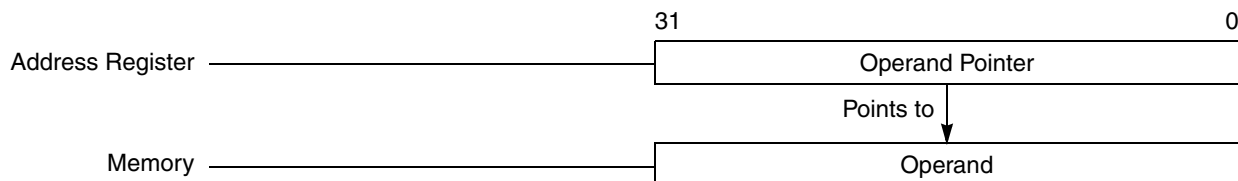

Figure 2-5. Address Register Indirect

2.2.4 Address Register Indirect with Postincrement Mode

In the address register indirect with postincrement mode, the operand is in memory. The effective address field specifies the address register containing the address of the operand in memory. After the operand address is used, it is incremented by one, two, or four, depending on the size of the operand (i.e., byte, word, or longword, respectively). Note that the stack pointer (A7) is treated exactly like any other address register.

Generation	EA = (An); An = An + Size
Assembler Syntax	(An)+
EA Mode Field	011
EA Register Field	Register number
Number of Extension Words	0

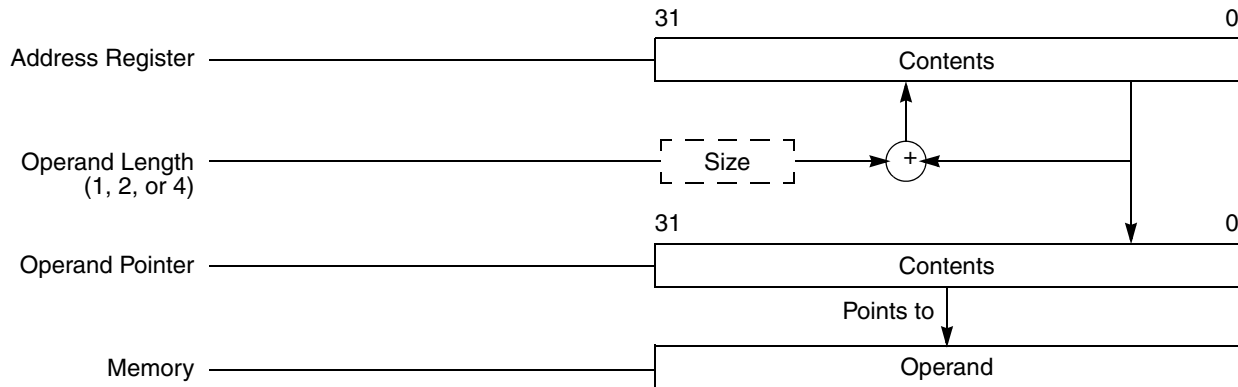

Figure 2-6. Address Register Indirect with Postincrement

2.2.5 Address Register Indirect with Predecrement Mode

In the address register indirect with predecrement mode, the operand is in memory. The effective address field specifies the address register containing the address of the operand in memory. Before the operand address is used, it is decremented by one, two, or four depending on the operand size (i.e., byte, word, or longword, respectively). Note that the stack pointer (A7) is treated just like the other address registers.

Generation	$EA = (An) - Size; An = An - Size;$
Assembler Syntax	$-(An)$
EA Mode Field	100
EA Register Field	Register number
Number of Extension Words	0

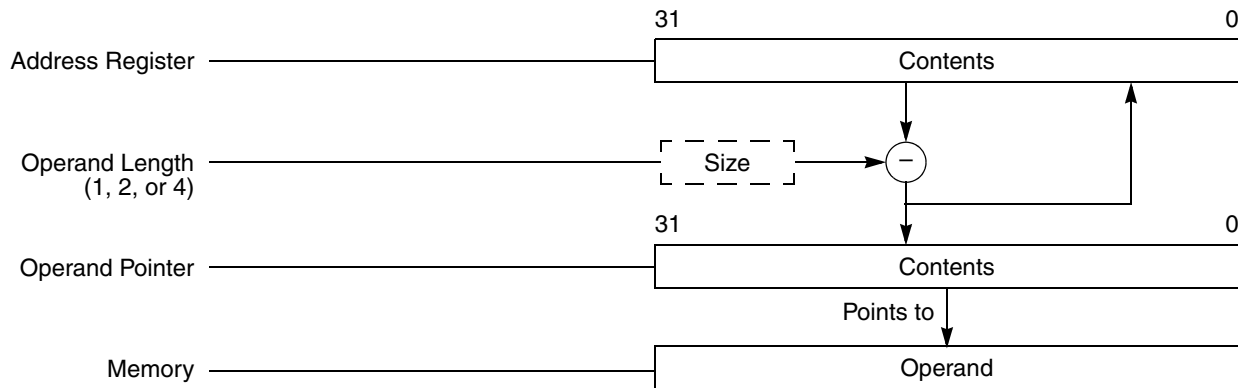

Figure 2-7. Address Register Indirect with Predecrement

2.2.6 Address Register Indirect with Displacement Mode

In the address register indirect with displacement mode, the operand is in memory. The operand address in memory consists of the sum of the address in the address register, which the effective address specifies, and the sign-extended 16-bit displacement integer in the extension word. Displacements are always sign-extended to 32 bits prior to being used in effective address calculations.

Generation	$EA = (An) + d_{16}$
Assembler Syntax	(d_{16}, An)
EA Mode Field	101
EA Register Field	Register number
Number of Extension Words	1

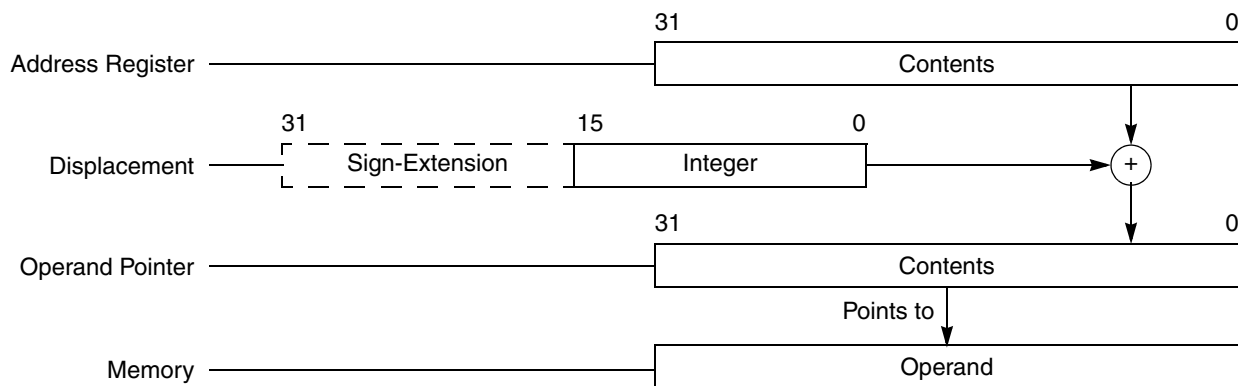

Figure 2-8. Address Register Indirect with Displacement

2.2.7 Address Register Indirect with Scaled Index and 8-Bit Displacement Mode

This addressing mode requires one extension word that contains an index register indicator, possibly scaled, and an 8-bit displacement. The index register indicator includes size and scale information. In this mode, the operand is in memory. The operand address is the sum of the address register contents; the sign-extended displacement value in the extension word's low-order 8 bits; and the scaled index register's sign-extended contents. Users must specify the address register, the displacement, the scale factor and the index register in this mode.

Generation	$EA = (An) + ((Xi) * ScaleFactor)) + \text{Sign-extended } d_8$
Assembler Syntax	$(d_8, An, Xi, Size * Scale)$
EA Mode Field	110
EA Register Field	Register number
Number of Extension Words	1

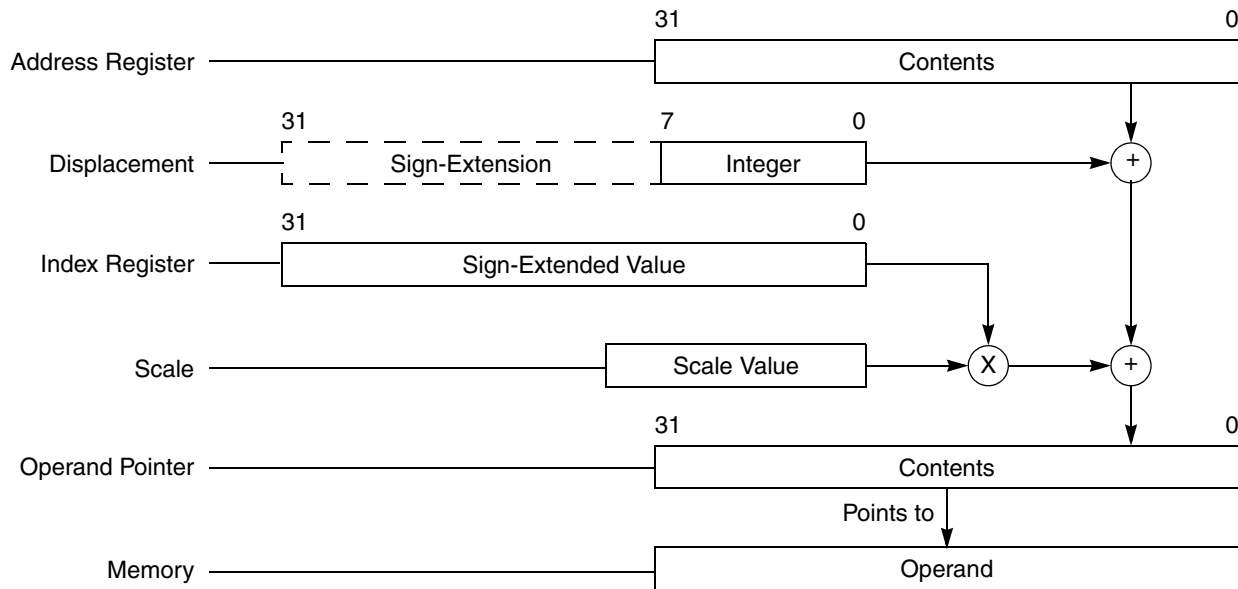

Figure 2-9. Address Register Indirect with Scaled Index and 8-Bit Displacement

2.2.8 Program Counter Indirect with Displacement Mode

In this mode, the operand is in memory. The address of the operand is the sum of the address in the program counter (PC) and the sign-extended 16-bit displacement integer in the extension word. The value in the PC at the time of address generation is $PC+2$, where PC is the address of the instruction operation word. This is a program reference allowed only for reads.

Generation	$EA = (PC) + d_{16}$
Assembler Syntax	(d_{16}, PC)
EA Mode Field	111
EA Register Field	010
Number of Extension Words	1

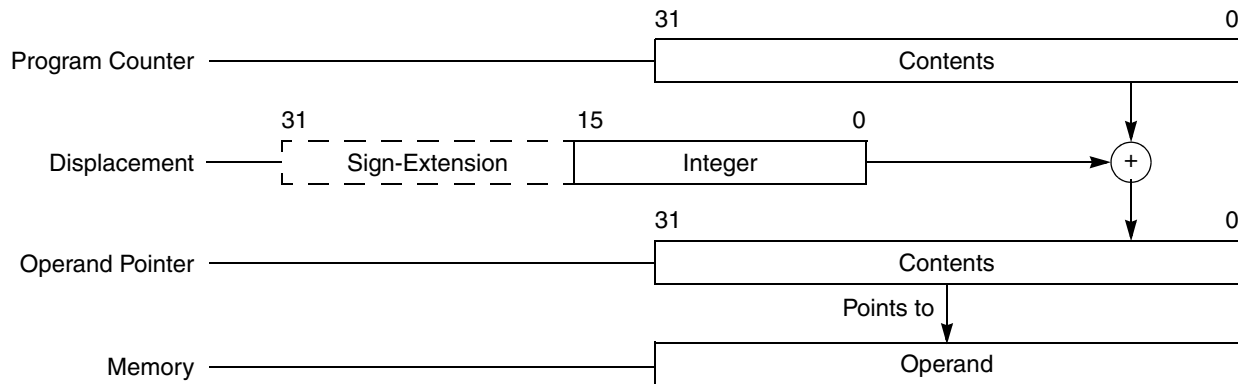

Figure 2-10. Program Counter Indirect with Displacement

2.2.9 Program Counter Indirect with Scaled Index and 8-Bit Displacement Mode

This mode is similar to the mode described in [Section 2.2.7, “Address Register Indirect with Scaled Index and 8-Bit Displacement Mode,”](#) except the PC is the base register. The operand is in memory. The operand address is the sum of the address in the PC, the sign-extended displacement integer in the extension word’s lower 8 bits, and the sized, scaled, and sign-extended index operand. The value in the PC at the time of address generation is $PC+2$, where PC is the address of the instruction operation word. This is a program reference allowed only for reads. Users must include the displacement, the scale, and the index register when specifying this addressing mode.

Generation	$EA = (PC) + ((Xi) * ScaleFactor) + \text{Sign-extended } d_8$
Assembler Syntax	$(d_8, PC, Xi, Size * Scale)$
EA Mode Field	111
EA Register Field	011
Number of Extension Words	1

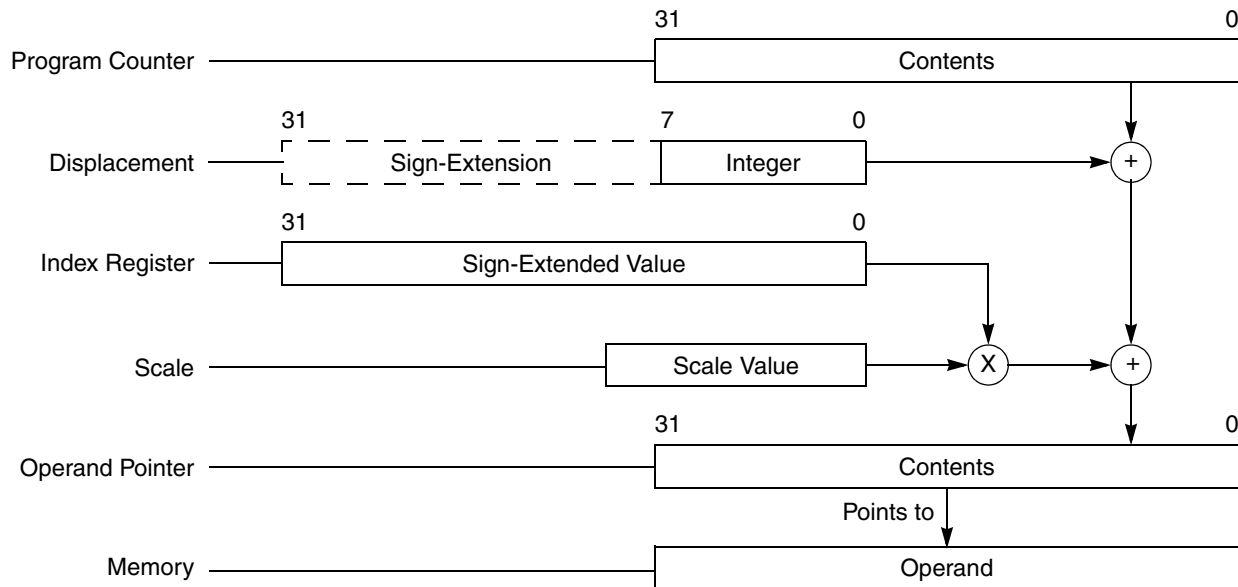

Figure 2-11. Program Counter Indirect with Scaled Index and 8-Bit Displacement

2.2.10 Absolute Short Addressing Mode

In this addressing mode, the operand is in memory, and the address of the operand is in the extension word. The 16-bit address is sign-extended to 32 bits before it is used.

Generation	EA Given
Assembler Syntax	$(xxx).W$
EA Mode Field	111
EA Register Field	000
Number of Extension Words	1

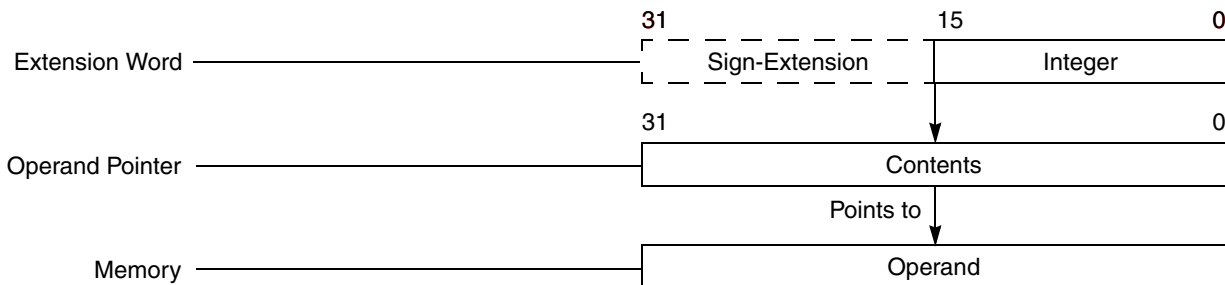

Figure 2-12. Absolute Short Addressing

2.2.11 Absolute Long Addressing Mode

In this addressing mode, the operand is in memory, and the operand address occupies the two extension words following the instruction word in memory. The first extension word contains the high-order part of the address; the second contains the low-order part of the address.

Generation	EA Given
Assembler Syntax	(xxx).L
EA Mode Field	111
EA Register Field	001
Number of Extension Words	2

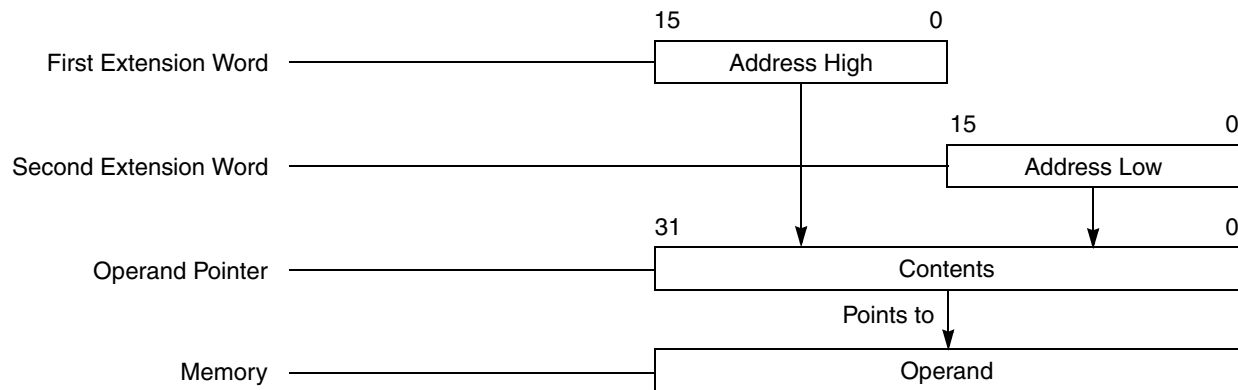

Figure 2-13. Absolute Long Addressing

2.2.12 Immediate Data

In this addressing mode, the operand is in 1 or 2 extension words. Table 2-2 lists the location of the operand within the instruction word format. The immediate data format is as follows:

Table 2-2. Immediate Operand Location

Operation Length	Location
Byte	Low-order byte of the extension word
Word	Entire extension word
Longword	High-order word of the operand is in the first extension word; the low-order word is in the second extension word.

Generation	Operand given
Assembler Syntax	#<xxx>
EA Mode Field	111
EA Register Field	100
Number of Extension Words	1 or 2

Figure 2-14. Immediate Data Addressing

2.2.13 Effective Addressing Mode Summary

Effective addressing modes are grouped according to the mode use. Data-addressing modes refer to data operands. Memory-addressing modes refer to memory operands. Alterable addressing modes refer to alterable (writable) operands. Control-addressing modes refer to memory operands without an associated size.

These categories sometimes combine to form new categories that are more restrictive. Two combined classifications are alterable memory (addressing modes that are both alterable and memory addresses) and data alterable (addressing modes that are both alterable and data). [Table 2-3](#) lists a summary of effective addressing modes and their categories.

Table 2-3. Effective Addressing Modes and Categories

Addressing Modes	Syntax	Mode Field	Reg. Field	Data	Memory	Control	Alterable
Register Direct							
Data	Dn	000	reg. no.	X	—	—	X
Address	An	001	reg. no.	—	—	—	X
Register Indirect							
Address	(An)	010	reg. no.	X	X	X	X
Address with Postincrement	(An)+	011	reg. no.	X	X	—	X
Address with Predecrement	-(An)	100	reg. no.	X	X	—	X
Address with Displacement	(d ₁₆ ,An)	101	reg. no.	X	X	X	X
Address Register Indirect with Scaled Index and 8-Bit Displacement	(d ₈ ,An,Xi*SF)	110	reg. no.	X	X	X	X
Program Counter Indirect with Displacement	(d ₁₆ ,PC)	111	010	X	X	X	—
Program Counter Indirect with Scaled Index and 8-Bit Displacement	(d ₈ ,PC,Xi*SF)	111	011	X	X	X	—
Absolute Data Addressing							
Short	(xxx).W	111	000	X	X	X	—
Long	(xxx).L	111	001	X	X	X	—
Immediate	#<xxx>	111	100	X	X	—	—

2.3 Stack

Address register A7 stacks exception frames, subroutine calls and returns, temporary variable storage, and parameter passing and is affected by instructions such as the LINK, UNLK, RTE, and PEA. To maximize performance, A7 must be longword-aligned at all times. Therefore, when modifying A7, be sure to do so in multiples of 4 to maintain alignment. To further ensure alignment of A7 during exception handling, the ColdFire architecture implements a self-aligning stack when processing exceptions.

Users can employ other address registers to implement other stacks using the address register indirect with postincrement and predecrement addressing modes. With an address register, users can implement a stack that fills either from high memory to low memory or vice versa. Users should keep in mind these important directives:

- Use the predecrement mode to decrement the register before using its contents as the pointer to the stack.
- Use the postincrement mode to increment the register after using its contents as the pointer to the stack.

- Maintain the stack pointer correctly when byte, word, and longword items mix in these stacks.

To implement stack growth from high memory to low memory, use $-(An)$ to push data on the stack and $(An)+$ to pull data from the stack. For this type of stack, after either a push or a pull operation, the address register points to the top item on the stack.

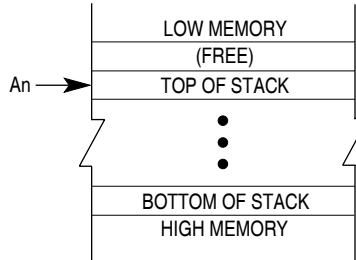

Figure 2-15. Stack Growth from High Memory to Low Memory

To implement stack growth from low memory to high memory, use $(An)+$ to push data on the stack and $-(An)$ to pull data from the stack. After either a push or pull operation, the address register points to the next available space on the stack.

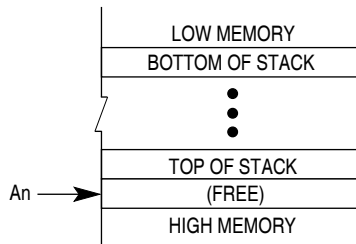

Figure 2-16. Stack Growth from Low Memory to High Memory



THIS PAGE INTENTIONALLY LEFT BLANK

Chapter 3

Instruction Set Summary

This section briefly describes the ColdFire Family instruction set, using Freescale’s assembly language syntax and notation. It includes instruction set details such as notation and format.

3.1 Instruction Summary

Instructions form a set of tools that perform the following types of operations:

- Data movement
- Program control
- Integer arithmetic
- Floating-point arithmetic
- Logical operations
- Shift operations
- Bit manipulation
- System control
- Cache maintenance

NOTE

The DIVS/DIVU and RES/REMU instructions are not implemented on the earliest V2-based devices MCR5202, MCF5204 and MCF5206.

Although MCF5407 device implements ISA_B, support for the User Stack Pointer (Move to/from USP) is not provided.

Table 3-14 shows the entire user instruction set in alphabetical order. Table 3-15 shows the entire supervisor instruction set in alphabetical order.

The following paragraphs detail the instruction for each type of operation. Table 3-1 lists the notations used throughout this manual. In the operand syntax statements of the instruction definitions, the operand on the right is the destination operand.

Table 3-1. Notational Conventions

Single- and Double-Operand Operations	
+	Arithmetic addition or postincrement indicator
–	Arithmetic subtraction or predecrement indicator
*	Arithmetic multiplication
/	Arithmetic division
~	Invert; operand is logically complemented
&	Logical AND
	Logical OR
⊥	Logical exclusive OR
→	Source operand is moved to destination operand

Table 3-1. Notational Conventions (Continued)

←→	Two operands are exchanged
<op>	Any double-operand operation
<operand>tested	Operand is compared to zero, and the condition codes are set appropriately
sign-extended	All bits of the upper portion are made equal to the high-order bit of the lower portion.
Other Operations	
If <condition> then <operations> else <operations>	Test the condition. If true, the operations after “then” are performed. If the condition is false and the optional “else” clause is present, the operations after “else” are performed. If the condition is false and else is omitted, the instruction performs no operation. Refer to the Bcc instruction description as an example.
Register Specifications	
<i>An</i>	Any address register <i>n</i> (example: A3 is address register 3)
<i>Ax, Ay</i>	Destination and source address registers, respectively
<i>Dn</i>	Any data register <i>n</i> (example: D5 is data register 5)
<i>Dx, Dy</i>	Destination and source data registers, respectively
<i>Dw</i>	Data register containing a remainder
<i>Rc</i>	Control register
<i>Rn</i>	Any address or data register
<i>Rx, Ry</i>	Any destination and source registers, respectively
<i>Xi</i>	Index register, can be any address or data register; all 32-bits are used.
Subfields and Qualifiers	
#<data>	Immediate data following the instruction word(s).
()	Identifies an indirect address in a register.
<i>d_n</i>	Displacement value, <i>n</i> bits wide (example: <i>d₁₆</i> is a 16-bit displacement).
<i>sz</i>	Size of operation: Byte (B), Word (W), Longword (L)
<i>lsb, msb</i>	Least significant bit, most significant bit
<i>LSW, MSW</i>	Least significant word, most significant word
<i>SF</i>	Scale factor for an index register
Register Names	
CCR	Condition Code Register (lower byte of status register)
PC	Program Counter
SR	Status Register
USP	User Stack Pointer
ic, dc, bc	Instruction, data, or both caches (unified cache uses bc)
Condition Codes	

Table 3-1. Notational Conventions (Continued)

*	General case
C	Carry bit in CCR
cc	Condition codes from CCR
N	Negative bit in CCR
V	Overflow bit in CCR
X	Extend bit in CCR
Z	Zero bit in CCR
—	Not affected or applicable
Miscellaneous	
<ea>x, <ea>y	Destination and source effective address, respectively
<label>	Assembly program label
#list	List of registers, for example D3–D0
MAC Operations	
ACC, ACCx	MAC accumulator register, a specific EMAC accumulator register
ACCx, ACCy	Destination and source accumulators, respectively
ACCext01	Four extension bytes associated with EMAC accumulators 0 and 1
ACCext23	Four extension bytes associated with EMAC accumulators 2 and 3
EV	Extension overflow flag in MACSR
MACSR	MAC status register
MASK	MAC mask register
PAVx	Product/accumulation overflow flags in MACSR
RxSF	A register containing a MAC operand that is to be scaled
Rw	Destination register for a MAC with load operation
Floating-Point Operations	
fmt	Format of operation: Byte (B), Word (W), Longword (L), Single-precision (S), Double-precision(D)
+inf	Positive infinity
-inf	Negative infinity
FPx, FPy	Destination and source floating-point data registers, respectively
FPCR	Floating-point control register
FPIAR	Floating-point instruction address register
FPSR	Floating-point status register
NAN	Not-a-number

3.1.1 Data Movement Instructions

The MOVE and FMOVE instructions with their associated addressing modes are the basic means of transferring and storing addresses and data. MOVE instructions transfer byte, word, and longword operands from memory to memory, memory to register, register to memory, and register to register. MOVEA instructions transfer word and longword operands and ensure that only valid address manipulations are executed. In addition to the general MOVE instructions, there are several special data movement instructions: MOV3Q, MOVEM, MOVEQ, MVS, MVZ, LEA, PEA, LINK, and UNLK. MOV3Q, MVS, and MVZ are ISA_B additions to the instruction set.

The FMOVE instructions move operands into, out of, and between floating-point data registers. FMOVE also moves operands to and from the FPCR, FPIAR, and FPSR. For operands moved into a floating-point data register, FSMOVE and FDMOVE explicitly select single- and double-precision rounding of the result. FMOVEM moves any combination of floating-point data registers. Table 3-2 lists the general format of these integer and floating-point data movement instructions.

Table 3-2. Data Movement Operation Format

Instruction	Operand Syntax	Operand Size	Operation	First Appeared: ISA, (E)MAC, or FPU
FDMOVE	FPy,FPx	D	Source → Destination; round destination to double	FPU
FMOVE	<ea>y,FPx FPy,<ea>x FPy,FPx FPcr,<ea>x <ea>y,FPcr	B,W,L,S,D B,W,L,S,D D L L	Source → Destination FPcr can be any floating-point control register: FPCR, FPIAR, FPSR	FPU
FMOVEM	#list,<ea>x <ea>y,#list	D	Listed registers → Destination Source → Listed registers	FPU
FSMOVE	<ea>y,FPx	B,W,L,S,D	Source → Destination; round destination to single	FPU
LEA	<ea>y,Ax	L	<ea>y → Ax	ISA_A
LINK	Ay,#<displacement>	W	SP - 4 → SP; Ay → (SP); SP → Ay, SP + d _n → SP	ISA_A
MOV3Q	#<data>,<ea>x	L	Immediate Data → Destination	ISA_B
MOVCLR	ACCy,Rx	L	Accumulator → Destination, 0 → Accumulator	EMAC
MOVE MOVE from CCR MOVE to CCR	<ea>y,<ea>x MACcr,Dx <ea>y,MACcr CCR,Dx <ea>y,CCR	B,W,L L L W W	Source → Destination where MACcr can be any MAC control register: ACCx, ACCext01, ACCext23, MACSR, MASK	ISA_A ¹ MAC ² MAC ² ISA_A ISA_A
MOVEA	<ea>y,Ax	W,L → L	Source → Destination	ISA_A
MOVEM	#list,<ea>x <ea>y,#list	L	Listed Registers → Destination Source → Listed Registers	ISA_A
MOVEQ	#<data>,Dx	B → L	Immediate Data → Destination	ISA_A
MVS	<ea>y,Dx	B,W	Source with sign extension → Destination	ISA_B
MVZ	<ea>y,Dx	B,W	Source with zero fill → Destination	ISA_B

Table 3-2. Data Movement Operation Format

PEA	<ea>y	L	SP - 4 → SP; <ea>y → (SP)	ISA_A
UNLK	Ax	none	Ax → SP; (SP) → Ax; SP + 4 → SP	ISA_A

¹ Support for certain effective addressing modes was introduced with ISA_B. See [Table 3-16](#).

² Supported for certain control registers was introduced with the eEMAC instruction set. See [Table 3-16](#)

3.1.2 Program Control Instructions

A set of subroutine call-and-return instructions and conditional and unconditional branch instructions perform program control operations. Also included are test operand instructions (TST and FTST), which set the integer or floating-point condition codes for use by other program and system control instructions. NOP forces synchronization of the internal pipelines. TPF is a no-operation instruction that does not force pipeline synchronization. [Table 3-3](#) summarizes these instructions.

Table 3-3. Program Control Operation Format

Instruction	Operand Syntax	Operand Size	Operation	First Appeared: ISA, (E)MAC, or FPU
Conditional				
Bcc	<label>	B, W, L	If Condition True, Then PC + d _n → PC	ISA_A ¹
FBcc	<label>	W, L	If Condition True, Then PC + d _n → PC	FPU
Scc	Dx	B	If Condition True, Then 1s → Destination; Else 0s → Destination	ISA_A
Unconditional				
BRA	<label>	B, W, L	PC + d _n → PC	ISA_A ¹
BSR	<label>	B, W, L	SP - 4 → SP; nextPC → (SP); PC + d _n → PC	ISA_A ¹
FNOP	none	none	PC + 2 → PC (FPU pipeline synchronized)	FPU
JMP	<ea>y	none	Source Address → PC	ISA_A
JSR	<ea>y	none	SP - 4 → SP; nextPC → (SP); Source → PC	ISA_A
NOP	none	none	PC + 2 → PC (Integer Pipeline Synchronized)	ISA_A
TPF	none #<data> #<data>	none W L	IPC + 2 → PC PC + 4 → PC PC + 6 → PC	ISA_A
Returns				ISA_A
RTS	none	none	(SP) → PC; SP + 4 → SP	
Test Operand				
TAS	<ea>x	B	Destination Tested → CCR; 1 → bit 7 of Destination	ISA_B

Table 3-3. Program Control Operation Format (Continued)

FTST	<ea>y	B, W, L, S, D	Source Operand Tested → FPCC	FPU
TST	<ea>y	B, W, L	Source Operand Tested → CCR	ISA_A

¹ Support for certain operand sizes was introduced with ISA_B. See [Table 3-16](#).

Letters cc in the integer instruction mnemonics Bcc and Scc specify testing one of the following conditions:

CC—Carry clear	GE—Greater than or equal
LS—Lower or same	PL—Plus
CS—Carry set	GT—Greater than
LT—Less than	T—Always true ¹
EQ—Equal	HI—Higher
MI—Minus	VC—Overflow clear
F—Never true ¹	LE—Less than or equal
NE—Not equal	VS—Overflow set

¹ Not applicable to the Bcc instructions.

For the definition of cc for FBcc, refer to [Section 7.2, “Conditional Testing.”](#)

3.1.3 Integer Arithmetic Instructions

The integer arithmetic operations include 5 basic operations: ADD, SUB, MUL, DIV, and REM. They also include CMP, CLR, and NEG. The instruction set includes ADD, CMP, and SUB instructions for both address and data operations. The CLR instruction applies to all sizes of data operands. Signed and unsigned MUL, DIV, and REM instructions include:

- word multiply to produce a longword product
- longword multiply to produce a longword product
- longword divided by a word with a word quotient and word remainder
- longword divided by a longword with a longword quotient
- longword divided by a longword with a longword remainder (REM)

A set of extended instructions provides multiprecision and mixed-size arithmetic: ADDX, SUBX, EXT, and NEGX. For devices with the optional MAC or EMAC unit, MAC and MSAC instructions are available. Refer to [Table 3-4](#) for a summary of the integer arithmetic operations. In [Table 3-4](#), X refers to the X-bit in the CCR.

Table 3-4. Integer Arithmetic Operation Format

Instruction	Operand Syntax	Operand Size	Operation	First appeared: ISA, (E)MAC or FPU
ADD	Dy,<ea>x	L	Source + Destination → Destination	ISA_A
ADDA	<ea>y,Dx <ea>y,Ax	L L		
ADDI	#<data>,Dx	L	Immediate Data + Destination → Destination	ISA_A
ADDQ	#<data>,<ea>x	L		

Table 3-4. Integer Arithmetic Operation Format (Continued)

ADDX	Dy,Dx	L	Source + Destination + CCR[X] → Destination	ISA_A
CLR	<ea>x	B, W, L	0 → Destination	ISA_A
CMP CMPA	<ea>y,Dx <ea>y,Ax	B, W, L W, L	Destination – Source → CCR	ISA_A ¹
CMPI	#<data>,Dx	B, W, L	Destination – Immediate Data → CCR	ISA_A ¹
DIVS/DIVU	<ea>y,Dx	W, L	Destination / Source → Destination (Signed or Unsigned)	ISA_A
EXT EXTB	Dx Dx Dx	B → W W → L B → L	Sign-Extended Destination → Destination	ISA_A
MAAAC	Ry, RxSF, ACCx, ACCw	W, L	ACCx + (Ry * Rx){<< >>} SF → ACCx ACCw + (Ry * Rx){<< >>} SF → ACCw	ISA_C EMAC_B
MAC	Ry,RxSF,ACCx Ry,RxSF,<ea>y,Rw,ACCx	W, L W, L	ACCx + (Ry * Rx){<< >>} SF → ACCx ACCx + (Ry * Rx){<< >>} SF → ACCx; (<ea>y(&MASK)) → Rw	ISA_A
MASAC	Ry, RxSF, ACCx, ACCw	W, L	ACCx + (Ry * Rx){<< >>} SF → ACCx ACCw - (Ry * Rx){<< >>} SF → ACCw	ISA_C EMAC_B
MSAAC	Ry, RxSF, ACCx, ACCw	W, L	ACCx - (Ry * Rx){<< >>} SF → ACCx ACCw + (Ry * Rx){<< >>} SF → ACCw	ISA_C EMAC_B
MSAC	Ry,RxSF,ACCx Ry,RxSF,<ea>y,Rw,ACCx	W, L W, L	ACCx - (Ry * Rx){<< >>} SF → ACCx ACCx - (Ry * Rx){<< >>} SF → ACCx; (<ea>y(&MASK)) → Rw	ISA_A
MSSAC	Ry, RxSF, ACCx, ACCw	W, L	ACCx - (Ry * Rx){<< >>} SF → ACCx ACCw - (Ry * Rx){<< >>} SF → ACCw	ISA_C EMAC_B
MULS/MULU	<ea>y,Dx	W * W → L L * L → L	Source * Destination → Destination (Signed or Unsigned)	ISA_A
NEG	Dx	L	0 – Destination → Destination	ISA_A
NEGX	Dx	L	0 – Destination – CCR[X] → Destination	ISA_A
REMS/REMU	<ea>y,Dw:Dx	L	Destination / Source → Remainder (Signed or Unsigned)	ISA_A
SATS	Dx	L	If CCR[V] == 1; then if Dx[31] == 0; then Dx[31:0] = 0x80000000; else Dx[31:0] = 0x7FFFFFFF; else Dx[31:0] is unchanged	ISA_B
SUB SUBA	<ea>y,Dx Dy,<ea>x <ea>y,Ax	L L L	Destination - Source → Destination	ISA_A
SUBI SUBQ	#<data>,Dx #<data>,<ea>x	L L	Destination – Immediate Data → Destination	ISA_A
SUBX	Dy,Dx	L	Destination – Source – CCR[X] → Destination	ISA_A

¹ Support for certain operand sizes was introduced with ISA_B. See [Table 3-16](#).

3.1.4 Floating-Point Arithmetic Instructions

The floating-point instructions are organized into two categories: dyadic (requiring two operands) and monadic (requiring one operand). The dyadic floating-point instructions provide several arithmetic functions such as FADD and FSUB. For these operations, the first operand can be located in memory, an integer data register, or a floating-point data register. The second operand is always located in a floating-point data register. The results of the operation are stored in the register specified as the second operand. All FPU arithmetic operations support all data formats. Results are rounded to either single- or double-precision format. [Table 3-5](#) gives the general format for these dyadic instructions. [Table 3-6](#) lists the available operations.

Table 3-5. Dyadic Floating-Point Operation Format

Instruction	Operand Syntax	Operand Size	Operation	First appeared: ISA, (E)MAC or FPU
F<dop>	<ea>y,FPx FPy,FPx	B, W, L, S, D	FPx <Function> Source → FPx	FPU

Table 3-6. Dyadic Floating-Point Operations

Instruction (F<dop>)	Operation
FADD, FSADD, FDADD	Add
FCMP	Compare
FDIV, FSDIV, FDDIV	Divide
FMUL, FSMUL, FDMUL	Multiply
FSUB, FSSUB, FDSUB	Subtract

The monadic floating-point instructions provide several arithmetic functions requiring one input operand such as FABS. Unlike the integer counterparts to these functions (e.g., NEG), a source and a destination can be specified. The operation is performed on the source operand and the result is stored in the destination, which is always a floating-point data register. All data formats are supported. [Table 3-7](#) gives the general format for these monadic instructions. [Table 3-8](#) lists the available operations.

Table 3-7. Monadic Floating-Point Operation Format

Instruction	Operand Syntax	Operand Size	Operation	First appeared: ISA, (E)MAC or FPU
F<mop>	<ea>y,FPx FPy,FPx FPx	B, W, L, S, D	Source → <Function> → FPx FPx → <Function> → FPx	FPU

Table 3-8. Monadic Floating-Point Operations

Instruction (F<mop>)	Operation
FABS, FSABS, FDABS	Absolute Value

Table 3-8. Monadic Floating-Point Operations

FINT	Extract Integer Part
FINTRZ	Extract Integer Part, Rounded to Zero
FNEG, FSNEG, FDNEG	Negate
FSQRT, FSSQRT, FDSQRT	Square Root

3.1.5 Logical Instructions

The instructions AND, OR, EOR, and NOT perform logical operations with longword integer data operands. A similar set of immediate instructions (ANDI, ORI, and EORI) provides these logical operations with longword immediate data. [Table 3-9](#) summarizes the logical operations.

Table 3-9. Logical Operation Format

Instruction	Operand Syntax	Operand Size	Operation	First appeared: ISA, (E)MAC or FPU
AND	<ea>y,Dx Dy,<ea>x	L L	Source & Destination → Destination	ISA_A
ANDI	#<data>, Dx	L	Immediate Data & Destination → Destination	ISA_A
EOR	Dy,<ea>x	L	Source ^ Destination → Destination	ISA_A
EORI	#<data>,Dx	L	Immediate Data ^ Destination → Destination	ISA_A
NOT	Dx	L	~ Destination → Destination	ISA_A
OR	<ea>y,Dx Dy,<ea>x	L L	Source Destination → Destination	ISA_A
ORI	#<data>,Dx	L	Immediate Data Destination → Destination	ISA_A

3.1.6 Shift Instructions

The ASR, ASL, LSR, and LSL instructions provide shift operations in both directions. All shift operations can be performed only on registers.

Register shift operations shift longwords. The shift count can be specified in the instruction operation word (to shift from 1 to 8 places) or in a register (modulo 64 shift count).

The SWAP instruction exchanges the 16-bit halves of a register. [Table 3-10](#) is a summary of the shift operations. In [Table 3-10](#), C and X refer to the C-bit and X-bit in the CCR.

Table 3-10. Shift Operation Format

Instruction	Operand Syntax	Operand Size	Operation	First appeared: ISA, (E)MAC or FPU
ASL	Dy,Dx #<data>,Dx	L L	CCR[X,C] ← (Dx << Dy) ← 0 CCR[X,C] ← (Dx << #<data>) ← 0	ISA_A
ASR	Dy,Dx #<data>,Dx	L L	msb → (Dx >> Dy) → CCR[X,C] msb → (Dx >> #<data>) → CCR[X,C]	ISA_A
LSL	Dy,Dx #<data>,Dx	L L	CCR[X,C] ← (Dx << Dy) ← 0 CCR[X,C] ← (Dx << #<data>) ← 0	ISA_A
LSR	Dy,Dx #<data>,Dx	L L	0 → (Dx >> Dy) → CCR[X,C] 0 → (Dx >> #<data>) → CCR[X,C]	ISA_A
SWAP	Dx	W	MSW of Dx ↔ LSW of Dx	ISA_A

3.1.7 Bit Manipulation Instructions

BTST, BSET, BCLR, and BCHG are bit manipulation instructions. All bit manipulation operations can be performed on either registers or memory. The bit number is specified either as immediate data or in the contents of a data register. Register operands are 32 bits long, and memory operands are 8 bits long. In addition, BITREV, BYTEREV and FF1 instructions provide additional functionality in this category and operate on 32-bit register data values. [Table 3-11](#) summarizes bit manipulation operations.

Table 3-11. Bit Manipulation Operation Format

Instruction	Operand Syntax	Operand Size	Operation	First appeared: ISA, (E)MAC or FPU
BCHG	Dy,<ea>x #<data>,<ea>x	B, L B, L	~ (<bit number> of Destination) → CCR[Z] → <bit number> of Destination	ISA_A
BCLR	Dy,<ea>x #<data>,<ea>x	B, L B, L	~ (<bit number> of Destination) → CCR[Z]; 0 → <bit number> of Destination	ISA_A
BITREV	Dx	L	Bit reversed Dx → Dx	ISA_A+, ISA_C
BSET	Dy,<ea>x #<data>,<ea>x	B, L B, L	~ (<bit number> of Destination) → CCR[Z]; 1 → <bit number> of Destination	ISA_A
BYTEREV	Dx	L	Byte reversed Dx → Dx	ISA_A+, ISA_C
BTST	Dy,<ea>x #<data>,<ea>x	B, L B, L	~ (<bit number> of Destination) → CCR[Z]	ISA_A
FF1	Dx	L	Bit offset of First Logical One “1” in Dx → Dx	ISA_A+, ISA_C

3.1.8 System Control Instructions

This type of instruction includes privileged and trapping instructions as well as instructions that use or modify the CCR. FSAVE and FRESTORE save and restore the nonuser visible portion of the FPU during context switches. [Table 3-12](#) summarizes these instructions.

Table 3-12. System Control Operation Format

Instruction	Operand Syntax	Operand Size	Operation	First appeared: ISA, (E)MAC or FPU
Privileged				
FRESTORE	<ea>y	none	FPU State Frame → Internal FPU State	FPU
FSAVE	<ea>x	none	Internal FPU State → FPU State Frame	FPU
HALT	none	none	Halt processor core (synchronizes pipeline)	ISA_A
MOVE from SR	SR,Dx	W	SR → Destination	ISA_A
MOVE from USP	USP,Dx	L	USP → Destination	ISA_B
MOVE to SR	<ea>y,SR	W	Source → SR; Dy or #<data> source only (synchronizes pipeline)	ISA_A
MOVE to USP	Ay,USP	L	Source → USP	ISA_B
MOVEC	Ry,Rc	L	Ry → Rc (synchronizes pipeline)	ISA_A
RTE	none	none	2 (SP) → SR; 4 (SP) → PC; SP + 8 → SP Adjust stack according to format (synchronizes pipeline)	ISA_A
STOP	#<data>	none	Immediate Data → SR; STOP (synchronizes pipeline)	ISA_A
STLDSR	#<data>	W	SP – 4 → SP; zero-filled SR → (SP); Immediate Data → SR	ISA_A+, ISA_C
WDEBUG	<ea>y	L	Addressed Debug WDMREG Command Executed (synchronizes pipeline)	ISA_A
Debug Functions				
PULSE	none	none	Set PST = 0x4	ISA_A
WDDATA	<ea>y	B, W, L	Source → DDATA port	ISA_A
Trap Generating				
ILLEGAL	none	none	SP – 4 → SP; PC → (SP) → PC; SP – 2 → SP; SR → (SP); SP – 2 → SP; Vector Offset → (SP); (VBR + 0x10) → PC	ISA_A
TRAP	#<vector>	none	1 → S Bit of SR; SP – 4 → SP; nextPC → (SP); SP – 2 → SP; SR → (SP) SP – 2 → SP; Format/Offset → (SP) (VBR + 0x80 + 4*n) → PC, where n is the TRAP number	ISA_A

Certain instructions perform a pipeline synchronization prior to their actual execution. For these opcodes, the instruction enters the OEP and then waits until the following conditions are met:

- The instruction cache is in a quiescent state with all outstanding cache misses completed.
- The data cache is in a quiescent state with all outstanding cache misses completed.
- The push/store buffer is empty.
- The execution of all previous instructions has completed.

Once all these conditions are satisfied, the instruction begins its actual execution. For the instruction timings listed in the timing data, the following assumptions are made for these pipeline synchronization instructions:

- The instruction cache is not processing any cache misses.
- The data cache is not processing any cache misses.
- The push/store buffer is empty.
- The OEP has dispatched an instruction or instruction-pair on the previous cycle.

The following instructions perform this pipeline synchronization:

- cpushl
- halt
- intouch
- move_to_sr
- movec
- nop
- rte
- stop
- wdebug

3.1.9 Cache Maintenance Instructions

The cache instructions provide maintenance functions for managing the caches. CPUSHL is used to push a specific cache line, and possibly invalidate it. INTOUCH can be used to load specific data into the cache. Both of these instructions are privileged instructions. [Table 3-13](#) summarizes these instructions.

Table 3-13. Cache Maintenance Operation Format

Instruction	Operand Syntax	Operand Size	Operation	First appeared: ISA, (E)MAC or FPU
CPUSHL	ic,(Ax) dc,(Ax) bc,(Ax)	none	If data is valid and modified, push cache line; invalidate line if programmed in CACR (synchronizes pipeline)	ISA_A
INTOUCH	Ay	none	Instruction fetch touch at (Ay) (synchronizes pipeline)	ISA_B

3.2 Instruction Set Summary

This section contains tables which summarize the ColdFire instruction set architecture.

[Table 3-14](#) shows the entire user instruction set in alphabetical order. [Table 3-15](#) shows the entire supervisor instruction set in alphabetical order. Recall the major ISA revisions are defined as:

- ISA_A: Original ColdFire instruction set architecture.
- ISA_B: Improved data movement instructions, byte- and word-sized compares, and miscellaneous enhancements are added.
- ISA_C: Instructions are added for improved bit manipulation.
- FPU: Floating-Point Unit instructions.
- MAC: Multiply-Accumulate instructions.
- EMAC: Revised ISA for enhanced Multiply-Accumulate unit.
- EMAC_B: Instructions are added for dual-accumulation operations.

Table 3-14. ColdFire User Instruction Set Summary

Instruction	Operand Syntax	Operand Size	Operation	First appeared: ISA, (E)MAC or FPU
ADD	Dy,<ea>x	L	Source + Destination → Destination	ISA_A
ADDA	<ea>y,Dx <ea>y,Ax	L L		
ADDI	#<data>,Dx	L	Immediate Data + Destination → Destination	ISA_A
ADDQ	#<data>,<ea>x	L		
ADDX	Dy,Dx	L	Source + Destination + CCR[X] → Destination	ISA_A
AND	<ea>y,Dx Dy,<ea>x	L L	Source & Destination → Destination	ISA_A
ANDI	#<data>, Dx	L	Immediate Data & Destination → Destination	ISA_A
ASL	Dy,Dx #<data>,Dx	L L	CCR[X,C] ← (Dx << Dy) ← 0 CCR[X,C] ← (Dx << #<data>) ← 0	ISA_A
ASR	Dy,Dx #<data>,Dx	L L	msb → (Dx >> Dy) → CCR[X,C] msb → (Dx >> #<data>) → CCR[X,C]	ISA_A
Bcc	<label>	B, W	If Condition True, Then PC + d _n → PC	ISA_A
Bcc	<label>	L	If Condition True, Then PC + d _n → PC	ISA_B
BCHG	Dy,<ea>x #<data>,<ea>x	B, L B, L	~ (<bit number> of Destination) → CCR[Z] → <bit number> of Destination	ISA_A
BCLR	Dy,<ea>x #<data>,<ea>x	B, L B, L	~ (<bit number> of Destination) → CCR[Z]; 0 → <bit number> of Destination	ISA_A
BITREV	Dx	L	Destination data register contents are bit-reversed	ISA_A+,ISA_C
BRA	<label>	B, W	PC + d _n → PC	ISA_A
BRA	<label>	L	PC + d _n → PC	ISA_B
BSET	Dy,<ea>x #<data>,<ea>x	B, L B, L	~ (<bit number> of Destination) → CCR[Z]; 1 → <bit number> of Destination	ISA_A
BSR	<label>	B, W	SP - 4 → SP; nextPC → (SP); PC + d _n → PC	ISA_A
BSR	<label>	L	SP - 4 → SP; nextPC → (SP); PC + d _n → PC	ISA_B

Table 3-14. ColdFire User Instruction Set Summary (Continued)

Instruction	Operand Syntax	Operand Size	Operation	First appeared: ISA, (E)MAC or FPU
BTST	Dy,<ea>x #<data>,<ea>x	B, L B, L	~ (<bit number> of Destination) → CCR[Z]	ISA_A
BYTEREV	Dx	L	Destination data register contents are byte-reversed	ISA_A+,ISA_C
CLR	<ea>x	B, W, L	0 → Destination	ISA_A
CMP CMPA	<ea>y,Dx <ea>y,Ax	L L	Destination – Source → CCR	ISA_A
CMP CMPA	<ea>y,Dx <ea>y,Ax	B, W W	Destination – Source → CCR	ISA_B
CMPI	#<data>,Dx	L	Destination – Immediate Data → CCR	ISA_A
CMPI	#<data>,Dx	B, W	Destination – Immediate Data → CCR	ISA_B
DIVS/DIVU	<ea>y,Dx	W, L	Destination / Source → Destination (Signed or Unsigned)	ISA_A
EOR	Dy,<ea>x	L	Source ^ Destination → Destination	ISA_A
EORI	#<data>,Dx	L	Immediate Data ^ Destination → Destination	ISA_A
EXT EXTB	Dx Dx Dx	B → W W → L B → L	Sign-Extended Destination → Destination	ISA_A
FABS	<ea>y,FPx FPy,FPx FPx	B,W,L,S,D D D	Absolute Value of Source → FPx Absolute Value of FPx → FPx	FPU
FADD	<ea>y,FPx FPy,FPx	B,W,L,S,D D	Source + FPx → FPx	FPU
FBcc	<label>	W, L	If Condition True, Then PC + d _n → PC	FPU
FCMP	<ea>y,FPx FPy,FPx	B,W,L,S,D D	FPx - Source	FPU
FDABS	<ea>y,FPx FPy,FPx FPx	B,W,L,S,D D D	Absolute Value of Source → FPx; round destination to double Absolute Value of FPx → FPx; round destination to double	FPU
FDADD	<ea>y,FPx FPy,FPx	B,W,L,S,D D	Source + FPx → FPx; round destination to double	FPU
FDDIV	<ea>y,FPx FPy,FPx	B,W,L,S,D D	FPx / Source → FPx; round destination to double	FPU
FDIV	<ea>y,FPx FPy,FPx	B,W,L,S,D D	FPx / Source → FPx	FPU
FDMOVE	FPy,FPx	D	Source → Destination; round destination to double	FPU

Table 3-14. ColdFire User Instruction Set Summary (Continued)

Instruction	Operand Syntax	Operand Size	Operation	First appeared: ISA, (E)MAC or FPU
FDMUL	<ea>y,FPx FPy,FPx	B,W,L,S,D D	Source * FPx → FPx; round destination to double	FPU
FDNEG	<ea>y,FPx FPy,FPx FPx	B,W,L,S,D D D	- (Source) → FPx; round destination to double - (FPx) → FPx; round destination to double	FPU
FDSQRT	<ea>y,FPx FPy,FPx FPx	B,W,L,S,D D D	Square Root of Source → FPx; round destination to double Square Root of FPx → FPx; round destination to double	FPU
FDSUB	<ea>y,FPx FPy,FPx	B,W,L,S,D D	FPx - Source → FPx; round destination to double	FPU
FF1	Dx	L	Bit offset of First Logical One in Register → Destination	ISA_A+,ISA_C
FINT	<ea>y,FPx FPy,FPx FPx	B,W,L,S,D D D	Integer Part of Source → FPx Integer Part of FPx → FPx	FPU
FINTRZ	<ea>y,FPx FPy,FPx FPx	B,W,L,S,D D D	Integer Part of Source → FPx; round to zero Integer Part of FPx → FPx; round to zero	FPU
FMOVE	<ea>y,FPx FPy,<ea>x FPy,FPx FPcr,<ea>x <ea>y,FPcr	B,W,L,S,D B,W,L,S,D D L L	Source → Destination FPcr can be any floating-point control register: FPCR, FPIAR, FPSR	FPU
FMOVEM	#list,<ea>x <ea>y,#list	D	Listed registers → Destination Source → Listed registers	FPU
FMUL	<ea>y,FPx FPy,FPx	B,W,L,S,D D	Source * FPx → FPx	FPU
FNEG	<ea>y,FPx FPy,FPx FPx	B,W,L,S,D D D	- (Source) → FPx - (FPx) → FPx	FPU
FNOP	none	none	PC + 2 → PC (FPU Pipeline Synchronized)	FPU
FSABS	<ea>y,FPx FPy,FPx FPx	B,W,L,S,D D D	Absolute Value of Source → FPx; round destination to single Absolute Value of FPx → FPx; round destination to single	FPU
FSADD	<ea>y,FPx FPy,FPx	B,W,L,S,D	Source + FPx → FPx; round destination to single	FPU
FSDIV	<ea>y,FPx FPy,FPx	B,W,L,S,D D	FPx / Source → FPx; round destination to single	FPU

Table 3-14. ColdFire User Instruction Set Summary (Continued)

Instruction	Operand Syntax	Operand Size	Operation	First appeared: ISA, (E)MAC or FPU
FSMOVE	<ea>y,FPx	B,W,L,S,D	Source → Destination; round destination to single	FPU
FSMUL	<ea>y,FPx FPy,FPx	B,W,L,S,D D	Source * FPx → FPx; round destination to single	FPU
FSNEG	<ea>y,FPx FPy,FPx FPx	B,W,L,S,D D D	- (Source) → FPx; round destination to single - (FPx) → FPx; round destination to single	FPU
FSQRT	<ea>y,FPx FPy,FPx FPx	B,W,L,S,D D D	Square Root of Source → FPx Square Root of FPx → FPx	FPU
FSSQRT	<ea>y,FPx FPy,FPx FPx	B,W,L,S,D D D	Square Root of Source → FPx; round destination to single Square Root of FPx → FPx; round destination to single	FPU
FSSUB	<ea>y,FPx FPy,FPx	B,W,L,S,D D	FPx - Source → FPx; round destination to single	FPU
FSUB	<ea>y,FPx FPy,FPx	B,W,L,S,D D	FPx - Source → FPx	FPU
FTST	<ea>y	B, W, L, S, D	Source Operand Tested → FPCC	FPU
ILLEGAL	none	none	SP - 4 → SP; PC → (SP) → PC; SP - 2 → SP; SR → (SP); SP - 2 → SP; Vector Offset → (SP); (VBR + 0x10) → PC	ISA_A
JMP	<ea>y	none	Source Address → PC	ISA_A
JSR	<ea>y	none	SP - 4 → SP; nextPC → (SP); Source → PC	ISA_A
LEA	<ea>y,Ax	L	<ea>y → Ax	ISA_A
LINK	Ay,#<displacement>	W	SP - 4 → SP; Ay → (SP); SP → Ay, SP + d _n → SP	ISA_A
LSL	Dy,Dx #<data>,Dx	L L	CCR[X,C] ← (Dx << Dy) ← 0 CCR[X,C] ← (Dx << #<data>) ← 0	ISA_A
LSR	Dy,Dx #<data>,Dx	L L	0 → (Dx >> Dy) → CCR[X,C] 0 → (Dx >> #<data>) → CCR[X,C]	ISA_A
MAAAC	Ry, RxSF, ACCx, ACCw	L	ACCx + (Ry * Rx){<< >>} SF → ACCx ACCw + (Ry * Rx){<< >>} SF → ACCw	ISA_C EMAC_B
MAC	Ry,RxSF,ACCx Ry,RxSF,<ea>y,Rw, ACCx	W, L W, L	ACCx + (Ry * Rx){<< >>}SF → ACCx ACCx + (Ry * Rx){<< >>}SF → ACCx; (<ea>y(&MASK)) → Rw	MAC
MASAC	Ry, RxSF, ACCx, ACCw	L	ACCx + (Ry * Rx){<< >>} SF → ACCx ACCw - (Ry * Rx){<< >>} SF → ACCw	ISA_C EMAC_B
MOV3Q	#<data>,<ea>x	L	Immediate Data → Destination	ISA_B

Table 3-14. ColdFire User Instruction Set Summary (Continued)

Instruction	Operand Syntax	Operand Size	Operation	First appeared: ISA, (E)MAC or FPU
MOVCLR	ACCy,Rx	L	Accumulator → Destination, 0 → Accumulator	EMAC
MOVE	<ea>y,<ea>x	B,W,L	Source → Destination	ISA_A
MOVE from CCR	MACCr,Dx	L	where MACCr can be any MAC control register: ACCx, ACCext01, ACCext23, MACSR, MASK	MAC
MOVE to CCR	<ea>y,MACCr	L		MAC
	CCR,Dx	W		ISA_A
	<ea>y,CCR	W		ISA_A
MOVE	#<data>, d16(Ax)	B,W	Immediate Data → Destination	ISA_B
MOVEA	<ea>y,Ax	W,L → L	Source → Destination	ISA_A
MOVEM	#list,<ea>x <ea>y,#list	L	Listed Registers → Destination Source → Listed Registers	ISA_A
MOVEQ	#<data>,Dx	B → L	Immediate Data → Destination	ISA_A
MSAAC	Ry, RxSF, ACCx, ACCw	L	ACCx - (Ry * Rx){<< >>} SF → ACCx ACCw + (Ry * Rx){<< >>} SF → ACCw	ISA_C EMAC_B
MSAC	Ry,RxSF,ACCx Ry,RxSF,<ea>y,Rw, ACCx	W, L W, L	ACCx - (Ry * Rx){<< >>}SF → ACCx ACCx - (Ry * Rx){<< >>}SF → ACCx; (<ea>y(&MASK)) → Rw	MAC
MSSAC	Ry, RxSF, ACCx, ACCw	L	ACCx - (Ry * Rx){<< >>} SF → ACCx ACCw - (Ry * Rx){<< >>} SF → ACCw	ISA_C EMAC_B
MULS/MULU	<ea>y,Dx	W * W → L L * L → L	Source * Destination → Destination (Signed or Unsigned)	ISA_A
MVS	<ea>y,Dx	B,W	Source with sign extension → Destination	ISA_B
MVZ	<ea>y,Dx	B,W	Source with zero fill → Destination	ISA_B
NEG	Dx	L	0 – Destination → Destination	ISA_A
NEGX	Dx	L	0 – Destination – CCR[X] → Destination	ISA_A
NOP	none	none	PC + 2 → PC (Integer Pipeline Synchronized)	ISA_A
NOT	Dx	L	~ Destination → Destination	ISA_A
OR	<ea>y,Dx Dy,<ea>x	L L	Source Destination → Destination	ISA_A
ORI	#<data>,Dx	L	Immediate Data Destination → Destination	ISA_A
PEA	<ea>y	L	SP – 4 → SP; <ea>y → (SP)	ISA_A
PULSE	none	none	Set PST = 0x4	ISA_A
REMS/REMU	<ea>y,Dw:Dx	L	Destination / Source → Remainder (Signed or Unsigned)	ISA_A
RTS	none	none	(SP) → PC; SP + 4 → SP	ISA_A

Table 3-14. ColdFire User Instruction Set Summary (Continued)

Instruction	Operand Syntax	Operand Size	Operation	First appeared: ISA, (E)MAC or FPU
SATS	Dx	L	If CCR[V] == 1; then if Dx[31] == 0; then Dx[31:0] = 0x80000000; else Dx[31:0] = 0x7FFFFFFF; else Dx[31:0] is unchanged	ISA_B
Scc	Dx	B	If Condition True, Then 1s → Destination; Else 0s → Destination	ISA_A
SUB SUBA	<ea>y,Dx Dy,<ea>x <ea>y,Ax	L L L	Destination - Source → Destination	ISA_A
SUBI SUBQ	#<data>,Dx #<data>,<ea>x	L L	Destination – Immediate Data → Destination	ISA_A
SUBX	Dy,Dx	L	Destination – Source – CCR[X] → Destination	ISA_A
SWAP	Dx	W	MSW of Dx ↔ LSW of Dx	ISA_A
TAS	<ea>x	B	Destination Tested → CCR; 1 → bit 7 of Destination	ISA_B
TPF	none #<data> #<data>	none W L	PC + 2 → PC PC + 4 → PC PC + 6 → PC	ISA_A
TRAP	#<vector>	none	1 → S Bit of SR; SP – 4 → SP; nextPC → (SP); SP – 2 → SP; SR → (SP) SP – 2 → SP; Format/Offset → (SP) (VBR + 0x80 + 4*n) → PC, where n is the TRAP number	ISA_A
TST	<ea>y	B, W, L	Source Operand Tested → CCR	ISA_A
UNLK	Ax	none	Ax → SP; (SP) → Ax; SP + 4 → SP	ISA_A
WDDATA	<ea>y	B, W, L	Source → DDATA port	ISA_A

Table 3-15. ColdFire Supervisor Instruction Set Summary

Instruction	Operand Syntax	Operand Size	Operation	First appeared: ISA, (E)MAC or FPU
CPUSHL	ic,(Ax) dc,(Ax) bc,(Ax)	none	If data is valid and modified, push cache line; invalidate line if programmed in CACR (synchronizes pipeline)	ISA_A
FRESTORE	<ea>y	none	FPU State Frame → Internal FPU State	FPU
FSAVE	<ea>x	none	Internal FPU State → FPU State Frame	FPU

Table 3-15. ColdFire Supervisor Instruction Set Summary

Instruction	Operand Syntax	Operand Size	Operation	First appeared: ISA, (E)MAC or FPU
HALT	none	none	Halt processor core	ISA_A
INTOUCH	Ay	none	Instruction fetch touch at (Ay)	ISA_B
MOVE from SR	SR,Dx	W	SR → Destination	ISA_A
MOVE from USP	USP,Dx	L	USP → Destination	ISA_B
MOVE to SR	<ea>y,SR	W	Source → SR; Dy or #<data> source only	ISA_A
MOVE to USP	Ay,USP	L	Source → USP	ISA_B
MOVEC	Ry,Rc	L	Ry → Rc	ISA_A
RTE	none	none	2 (SP) → SR; 4 (SP) → PC; SP + 8 → SP Adjust stack according to format	ISA_A
STLDSR	#<data>	W	SP – 4 → SP; zero-filled SR → (SP); Immediate Data → SR	ISA_A+,ISA_C
STOP	#<data>	none	Immediate Data → SR; STOP	ISA_A
WDEBUG	<ea>y	L	Addressed Debug WDMREG Command Executed	ISA_A

3.3 ColdFire Core Summary

This chapter provides a quick reference of the entire ColdFire instruction set architecture and the appropriate revision. [Table 3-16](#) provides an alphabetical list of the entire set of instruction mnemonics, and the associated instruction set revisions. For more detailed descriptions of the instructions, see [Table 3-14](#) on page 3-13 and [Table 3-15](#) on page 3-18.

The standard products available at the time of publication of this document and the cores and optional modules that they contain are shown in [Table 3-16](#).

Table 3-16. ColdFire Instruction Set and Processor Cross-Reference

Mnemonic	Description	ISA_A	ISA_A+	ISA_B	ISA_C	FPU	MAC	EMAC	EMAC_B
ADD	Add	X	X	X	X				
ADDA	Add Address	X	X	X	X				
ADDI	Add Immediate	X	X	X	X				
ADDQ	Add Quick	X	X	X	X				
ADDX	Add with Extend	X	X	X	X				
AND	Logical AND	X	X	X	X				
ANDI	Logical AND Immediate	X	X	X	X				
ASL, ASR	Arithmetic Shift Left and Right	X	X	X	X				
Bcc.{B,W}	Branch Conditionally, Byte and Word	X	X	X	X				

Table 3-16. ColdFire Instruction Set and Processor Cross-Reference (Continued)

Mnemonic	Description	ISA_A	ISA_A+	ISA_B	ISA_C	FPU	MAC	EMAC	EMAC_B
Bcc.L	Branch Conditionally, Longword			X	X				
BCHG	Test Bit and Change	X	X	X	X				
BCLR	Test Bit and Clear	X	X	X	X				
BITREV	Bit Reverse		X		X				
BRA.{B,W}	Branch Always, Byte and Word	X	X	X	X				
BRA.L	Branch Always, Longword		X	X					
BSET	Test Bit and Set	X	X	X	X				
BSR.{B,W}	Branch to Subroutine, Byte and Word	X	X	X	X				
BSR.L	Branch to Subroutine, Longword			X	X				
BTST	Test a Bit	X	X	X	X				
BYTEREV	Byte Reverse		X		X				
CLR	Clear	X	X	X	X				
CMP.{B,W}	Compare, Byte and Word			X	X				
CMPL	Compare, Longword	X	X	X	X				
CMPA.W	Compare Address, Word			X	X				
CMPA.L	Compare Address, Longword	X	X	X	X				
CMPI.{B,W}	Compare Immediate, Byte and Word			X	X				
CMPI.L	Compare Immediate, Longword	X	X	X	X				
CPUSHL	Push and Possibly Invalidate Cache	X	X	X	X				
DIVS	Signed Divide	X	X	X	X				
DIVU	Unsigned Divide	X	X	X	X				
EOR	Logical Exclusive-OR	X	X	X	X				
EORI	Logical Exclusive-OR Immediate	X	X	X	X				
EXT, EXTB	Sign Extend	X	X	X	X				
FABS, FSABS FDABS	Floating-Point Absolute Value					X			
FADD, FSADD, FDADD	Floating-Point Add					X			
FBcc	Floating-Point Branch Conditionally					X			
FCMP	Floating-Point Compare					X			
FDIV, FSDIV, FDDIV	Floating-Point Divide					X			
FF1	Find First One		X		X				

Table 3-16. ColdFire Instruction Set and Processor Cross-Reference (Continued)

Mnemonic	Description	ISA_A	ISA_A+	ISA_B	ISA_C	FPU	MAC	EMAC	EMAC_B
FFINT, FSINT, FDINT	Floating-Point Integer					X			
FINTRZ	Floating-Point Integer Round-to-Zero					X			
FMOVE, FSMOVE, FDMOVE	Move Floating-Point Data Register					X			
FMOVE from FPCR	Move from the Floating-Point Control Register					X			
FMOVE from FPIAR	Move from the Floating-Point Instruction Address Register					X			
FMOVE from FPSR	Move from the Floating-Point Status Register					X			
FMOVE to FPCR	Move to the Floating-Point Control Register					X			
FMOVE to FPIAR	Move to the Floating-Point Instruction Address Register					X			
FMOVE to FPSR	Move to the Floating-Point Status Register					X			
FMOVEM	Move Multiple Floating-Point Data Registers					X			
FMUL, FSMUL, FDMUL	Floating-Point Data Registers					X			
FNEG, FSNEG, FDNEG	Floating-Point Negate					X			
FNOP	Floating-Point No Operation					X			
FRESTORE	Restore Internal Floating-Point State					X			
FSAVE	Save Internal Floating-Point State					X			
FSQRT, FSSQRT, FDSQRT	Floating-Point Square Root					X			
FSUB	Floating-Point Subtract					X			
FTST	Test Floating-Point Operand					X			
HALT	Halt CPU	X	X	X	X				
ILLEGAL	Take Illegal Instruction Trap	X	X	X	X				
INTOUCH	Instruction Fetch Touch			X	X				
JMP	Jump	X	X	X	X				

Table 3-16. ColdFire Instruction Set and Processor Cross-Reference (Continued)

Mnemonic	Description	ISA_A	ISA_A+	ISA_B	ISA_C	FPU	MAC	EMAC	EMAC_B
JSR	Jump to Subroutine	X	X	X	X				
LEA	Load Effective Address	X	X	X	X				
LINK	Link and Allocate	X	X	X	X				
LSL, LSR	Logical Shift Left and Right	X	X	X	X				
MAAAC	Multiply and Add to 1st Accumulator, Add to 2nd Accumulator								X
MAC	Multiply and Accumulate						X	X	X
MASAC	Multiply and Add to 1st Accumulator, Subtract from 2nd Accumulator								X
MOV3Q	Move 3-Bit Data Quick			X	X				
MOVCLR	Move from Accumulator and Clear							X	X
MOVE	Move	X	X	X	X				
MOVEI	Move Immediate, Byte and Word to Ax with Displacement			X	X				
MOVE ACC to ACC	Copy Accumulator							X	X
MOVE from ACC	Move from Accumulator						X	X	X
MOVE from ACCext01	Move from Accumulator 0 and 1 Extensions							X	X
MOVE ACCext23	Move from Accumulator 2 and 3 Extensions							X	X
MOVE from CCR	Move from Condition Code Register	X	X	X	X				
MOVE from MACSR	Move from MAC Status Register						X	X	X
MOVE from MACSR to CCR	Move from MAC Status Register to Condition Code Register						X	X	X
MOVE from MASK	Move from MAC Mask Register						X	X	X
MOVE from SR	Move from the Status Register	X	X	X	X				
MOVE from USP	Move from User Stack Pointer		X	X	X				
MOVE to ACC	Move to Accumulator						X	X	X
MOVE to ACCext01	Move to Accumulator 0 and 1 Extensions							X	X

Table 3-16. ColdFire Instruction Set and Processor Cross-Reference (Continued)

Mnemonic	Description	ISA_A	ISA_A+	ISA_B	ISA_C	FPU	MAC	EMAC	EMAC_B
MOVE ACCext23	Move to Accumulator 2 and 3 Extensions							X	X
MOVE to CCR	Move to Condition Code Register	X	X	X	X				
MOVE to MACSR	Move to MAC Status Register						X	X	X
MOVE to MASK	Move to MAC Mask Register						X	X	X
MOVE to SR	Move to the Status Register	X	X	X	X				
MOVE to USP	Move to User Stack Pointer		X	X	X				
MOVEA	Move Address	X	X	X	X				
MOVEC	Move Control Register	X	X	X	X				
MOVEM	Move Multiple Registers	X	X	X	X				
MOVEQ	Move Quick	X	X	X	X				
MSAAC	Multiply and Subtract to 1st Accumulator, Add to 2nd Accumulator								X
MSAC	Multiply and Subtract						X	X	X
MSSAC	Multiply and Subtract to 1st Accumulator, Subtract to 2nd Accumulator								X
MULS	Signed Multiply	X	X	X	X				
MULU	Unsigned Multiply	X	X	X	X				
MVS	Move with Sign Extend			X	X				
MVZ	Move with Zero-Fill			X	X				
NEG	Negate	X	X	X	X				
NEGX	Negate with Extend	X	X	X	X				
NOP	No Operation	X	X	X	X				
NOT	Logical Complement	X	X	X	X				
OR	Logical Inclusive-OR	X	X	X	X				
ORI	Logical Inclusive-OR Immediate	X	X	X	X				
PEA	Push Effective Address	X	X	X	X				
PULSE	Generate Processor Status	X	X	X	X				
REMS	Signed Divide Remainder	X	X	X	X				
REMU	Unsigned Divide Remainder	X	X	X	X				
RTE	Return from Exception	X	X	X	X				

Table 3-16. ColdFire Instruction Set and Processor Cross-Reference (Continued)

Mnemonic	Description	ISA_A	ISA_A+	ISA_B	ISA_C	FPU	MAC	EMAC	EMAC_B
RTS	Return from Subroutine	X	X	X	X				
SATS	Signed Saturate			X	X				
Scc	Set According to Condition	X	X	X	X				
STLDSR	Store and Load Status Register		X		X				
STOP	Load Status Register and Stop	X	X	X	X				
SUB	Subtract	X	X	X	X				
SUBA	Subtract Address	X	X	X	X				
SUBI	Subtract Immediate	X	X	X	X				
SUBQ	Subtract Quick	X	X	X	X				
SUBX	Subtract with Extend	X	X	X	X				
SWAP	Swap Register Words	X	X	X	X				
TAS	Test and Set and Operand			X	X				
TPF	Trap False	X	X	X	X				
TRAP	Trap	X	X	X	X				
TST	Test Operand	X	X	X	X				
UNLK	Unlink	X	X	X	X				
WDDATA	Write Data Control Register	X	X	X	X				
WDEBUG	Write Debug Control Register	X	X	X	X				

Chapter 4

Integer User Instructions

This section describes the integer user instructions for the ColdFire Family. A detailed discussion of each instruction description is arranged in alphabetical order by instruction mnemonic.

Not all instructions are supported by all ColdFire processors. See [Chapter 3, “Instruction Set Summary](#) for specific details on the instruction set definitions.

ADD

Add

ADD

First appeared in ISA_A

Operation: Source + Destination → Destination

Assembler Syntax: ADD.L <ea>y,Dx
ADD.L Dy,<ea>x

Attributes: Size = longword

Description: Adds the source operand to the destination operand using binary addition and stores the result in the destination location. The size of the operation may only be specified as a longword. The mode of the instruction indicates which operand is the source and which is the destination as well as the operand size.

The Dx mode is used when the destination is a data register; the destination <ea>x mode is invalid for a data register.

In addition, ADDA is used when the destination is an address register. ADDI and ADDQ are used when the source is immediate data.

Condition Codes:	X	N	Z	V	C	
	*	*	*	*	*	

X Set the same as the carry bit
 N Set if the result is negative; cleared otherwise
 Z Set if the result is zero; cleared otherwise
 V Set if an overflow is generated; cleared otherwise
 C Set if an carry is generated; cleared otherwise

Instruction Format:	15	14	13	12	11	10	9	8	7	6	5	4	3	2	1	0
	1	1	0	1	Register				Opmode				Effective Address			
													Mode		Register	

Instruction Fields:

- Register field—Specifies the data register.
- Opmode field:

Byte	Word	Longword	Operation
—	—	010	<ea>y + Dx → Dx
—	—	110	Dy + <ea>x → <ea>x

ADD

Add

ADD

Instruction Fields (continued):

- Effective Address field—Determines addressing mode
 - For the source operand <ea>y, use addressing modes listed in the following table:

Addressing Mode	Mode	Register	Addressing Mode	Mode	Register
Dy	000	reg. number:Dy	(xxx).W	111	000
Ay	001	reg. number:Ay	(xxx).L	111	001
(Ay)	010	reg. number:Ay	#<data>	111	100
(Ay) +	011	reg. number:Ay			
– (Ay)	100	reg. number:Ay			
(d ₁₆ ,Ay)	101	reg. number:Ay	(d ₁₆ ,PC)	111	010
(d ₈ ,Ay,Xi)	110	reg. number:Ay	(d ₈ ,PC,Xi)	111	011

- For the destination operand <ea>x, use addressing modes listed in the following table:

Addressing Mode	Mode	Register	Addressing Mode	Mode	Register
Dx	—	—	(xxx).W	111	000
Ax	—	—	(xxx).L	111	001
(Ax)	010	reg. number:Ax	#<data>	—	—
(Ax) +	011	reg. number:Ax			
– (Ax)	100	reg. number:Ax			
(d ₁₆ ,Ax)	101	reg. number:Ax	(d ₁₆ ,PC)	—	—
(d ₈ ,Ax,Xi)	110	reg. number:Ax	(d ₈ ,PC,Xi)	—	—

ADDA

Add Address
First appeared in ISA_A

ADDA

Operation: Source + Destination → Destination

Assembler Syntax: ADDA.L <ea>y,Ax

Attributes: Size = longword

Description: Operates similarly to ADD, but is used when the destination register is an address register rather than a data register. Adds the source operand to the destination address register and stores the result in the address register. The size of the operation is specified as a longword.

Condition Codes: Not affected

Instruction Format:

15	14	13	12	11	10	9	8	7	6	5	4	3	2	1	0	
1	1	0	1	Destination Register, Ax				1	1	1	Source Effective Address					
										Mode			Register			

Instruction Fields:

- Destination Register field—Specifies the destination register, Ax.
- Source Effective Address field— Specifies the source operand; use addressing modes listed in the following table:

Addressing Mode	Mode	Register	Addressing Mode	Mode	Register
Dy	000	reg. number:Dy	(xxx).W	111	000
Ay	001	reg. number:Ay	(xxx).L	111	001
(Ay)	010	reg. number:Ay	#<data>	111	100
(Ay) +	011	reg. number:Ay			
– (Ay)	100	reg. number:Ay			
(d ₁₆ ,Ay)	101	reg. number:Ay	(d ₁₆ ,PC)	111	010
(d ₈ ,Ay,Xi)	110	reg. number:Ay	(d ₈ ,PC,Xi)	111	011

ADDI

Add Immediate First appeared in ISA_A

ADDI

Operation: Immediate Data + Destination → Destination

Assembler Syntax: ADDI.L #<data>,Dx

Attributes: Size = longword

Description: Operates similarly to ADD, but is used when the source operand is immediate data. Adds the immediate data to the destination operand and stores the result in the destination data register, Dx. The size of the operation is specified as longword. The size of the immediate data is specified as a longword. Note that the immediate data is contained in the two extension words, with the first extension word, bits [15:0], containing the upper word, and the second extension word, bits [15:0], containing the lower word.

Condition Codes:

X	N	Z	V	C
*	*	*	*	*

- X Set the same as the carry bit
- N Set if the result is negative; cleared otherwise
- Z Set if the result is zero; cleared otherwise
- V Set if an overflow is generated; cleared otherwise
- C Set if an carry is generated; cleared otherwise

Instruction Format:

15	14	13	12	11	10	9	8	7	6	5	4	3	2	1	0
0	0	0	0	0	1	1	0	1	0	0	0	0	Register, Dx		
Upper Word of Immediate Data															
Lower Word of Immediate Data															

Instruction Fields:

- Destination Register field - Specifies the destination data register, Dx.

ADDQ

Add Quick
First appeared in ISA_A

ADDQ

Operation: Immediate Data + Destination → Destination

Assembler Syntax: ADDQ.L #<data>,<ea>x

Attributes: Size = longword

Description: Operates similarly to ADD, but is used when the source operand is immediate data ranging in value from 1 to 8. Adds the immediate value to the operand at the destination location. The size of the operation is specified as longword. The immediate data is zero-filled to a longword before being added to the destination. When adding to address registers, the condition codes are not altered.

Condition Codes:	X	N	Z	V	C	X	Set the same as the carry bit
	*	*	*	*	*	N	Set if the result is negative; cleared otherwise
						Z	Set if the result is zero; cleared otherwise
						V	Set if an overflow is generated; cleared otherwise
						C	Set if an carry is generated; cleared otherwise

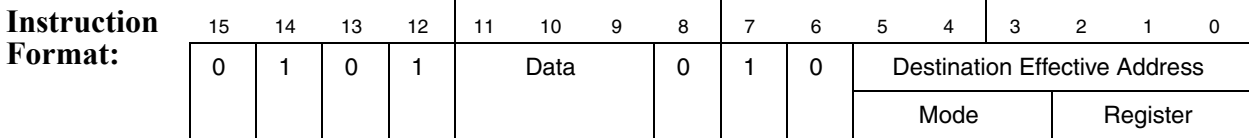

Instruction Fields:

- Data field—3 bits of immediate data representing 8 values (0 – 7), with 1-7 representing values of 1-7 respectively and 0 representing a value of 8.
- Destination Effective Address field—Specifies the destination location, <ea>x; use only those alterable addressing modes listed in the following table:

Addressing Mode	Mode	Register	Addressing Mode	Mode	Register
Dx	000	reg. number:Dx	(xxx).W	111	000
Ax	001	reg. number:Ax	(xxx).L	111	001
(Ax)	010	reg. number:Ax	#<data>	—	—
(Ax) +	011	reg. number:Ax			
– (Ax)	100	reg. number:Ax			
(d ₁₆ ,Ax)	101	reg. number:Ax	(d ₁₆ ,PC)	—	—
(d ₈ ,Ax,Xi)	110	reg. number:Ax	(d ₈ ,PC,Xi)	—	—

ADDX

Add Extended First appeared in ISA_A

ADDX

Operation: Source + Destination + CCR[X] → Destination

Assembler Syntax: ADDX.L Dy,Dx

Attributes: Size = longword

Description: Adds the source operand and CCR[X] to the destination operand and stores the result in the destination location. The size of the operation is specified as a longword.

Condition Codes:	X	N	Z	V	C	X Set the same as the carry bit
	*	*	*	*	*	N Set if the result is negative; cleared otherwise
						Z Cleared if the result is non-zero; unchanged otherwise
						V Set if an overflow is generated; cleared otherwise
						C Set if an carry is generated; cleared otherwise

Normally CCR[Z] is set explicitly via programming before the start of an ADDX operation to allow successful testing for zero results upon completion of multiple-precision operations.

Instruction Format:	15	14	13	12	11	10	9	8	7	6	5	4	3	2	1	0
	1	1	0	1	Register, Dx				1	1	0	0	0	Register, Dy		

Instruction Fields:

- Register Dx field—Specifies the destination data register, Dx.
- Register Dy field—Specifies the source data register, Dy.

AND

AND Logical First appeared in ISA_A

AND

Operation: Source & Destination → Destination

Assembler Syntax: AND.L <ea>y,Dx
AND.L Dy,<ea>x

Attributes: Size = longword

Description: Performs an AND operation of the source operand with the destination operand and stores the result in the destination location. The size of the operation is specified as a longword. Address register contents may not be used as an operand.

The Dx mode is used when the destination is a data register; the destination <ea> mode is invalid for a data register.

ANDI is used when the source is immediate data.

Condition Codes:	X	N	Z	V	C	
	—	*	*	0	0	

X Not affected
N Set if the msb of the result is set; cleared otherwise
Z Set if the result is zero; cleared otherwise
V Always cleared
C Always cleared

Instruction Format:	15	14	13	12	11	10	9	8	7	6	5	4	3	2	1	0
	1	1	0	0	Data Register				Opmode			Effective Address				
													Mode		Register	

Instruction Fields:

- Register field—Specifies any of the 8 data registers.
- Opmode field:

Byte	Word	Longword	Operation
—	—	010	<ea>y & Dx → Dx
—	—	110	Dy & <ea>x → <ea>x

AND

AND Logical

AND

Instruction Fields (continued):

- Effective Address field—Determines addressing mode.
 - For the source operand <ea>y, use addressing modes listed in the following table:

Addressing Mode	Mode	Register	Addressing Mode	Mode	Register
Dy	000	reg. number:Dy	(xxx).W	111	000
Ay	—	—	(xxx).L	111	001
(Ay)	010	reg. number:Ay	#<data>	111	100
(Ay) +	011	reg. number:Ay			
– (Ay)	100	reg. number:Ay			
(d ₁₆ ,Ay)	101	reg. number:Ay	(d ₁₆ ,PC)	111	010
(d ₈ ,Ay,Xi)	110	reg. number:Ay	(d ₈ ,PC,Xi)	111	011

- For the destination operand <ea>x, use addressing modes listed in the following table:

Addressing Mode	Mode	Register	Addressing Mode	Mode	Register
Dx	—	—	(xxx).W	111	000
Ax	—	—	(xxx).L	111	001
(Ax)	010	reg. number:Ax	#<data>	—	—
(Ax) +	011	reg. number:Ax			
– (Ax)	100	reg. number:Ax			
(d ₁₆ ,Ax)	101	reg. number:Ax	(d ₁₆ ,PC)	—	—
(d ₈ ,Ax,Xi)	110	reg. number:Ax	(d ₈ ,PC,Xi)	—	—

ANDI

AND Immediate First appeared in ISA_A

ANDI

Operation: Immediate Data & Destination → Destination

Assembler Syntax: ANDI.L #<data>,Dx

Attributes: Size = longword

Description: Performs an AND operation of the immediate data with the destination operand and stores the result in the destination data register, Dx. The size of the operation is specified as a longword. The size of the immediate data is specified as a longword. Note that the immediate data is contained in the two extension words, with the first extension word, bits [15:0], containing the upper word, and the second extension word, bits [15:0], containing the lower word.

Condition Codes:	X	N	Z	V	C	X Not affected
	—	*	*	0	0	N Set if the msb of the result is set; cleared otherwise
						Z Set if the result is zero; cleared otherwise
						V Always cleared
						C Always cleared

Instruction Format:

15	14	13	12	11	10	9	8	7	6	5	4	3	2	1	0
0	0	0	0	0	0	1	0	1	0	0	0	0	Destination Register, Dx		
Upper Word of Immediate Data															
Lower Word of Immediate Data															

Instruction Fields:

- Destination Register field - specifies the destination data register, Dx.

ASL, ASR

Arithmetic Shift
First appeared in ISA_A

ASL, ASR

Operation: Destination Shifted By Count → Destination

Assembler Syntax: ASd.L Dy,Dx
ASd.L #<data>,Dx
where d is direction, L or R

Attributes: Size = longword

Description: Arithmetically shifts the bits of the destination operand, Dx, in the direction (L or R) specified. The size of the operand is a longword. CCR[C] receives the last bit shifted out of the operand. The shift count is the number of bit positions to shift the destination register and may be specified in two different ways:

1. Immediate—The shift count is specified in the instruction (shift range is 1 – 8).
2. Register—The shift count is the value in the data register, Dy, specified in the instruction (modulo 64).

For ASL, the operand is shifted left; the shift count equals the number of positions shifted. Bits shifted out of the high-order bit go to both the carry and the extend bits; zeros are shifted into the low-order bit. The overflow bit is always zero.

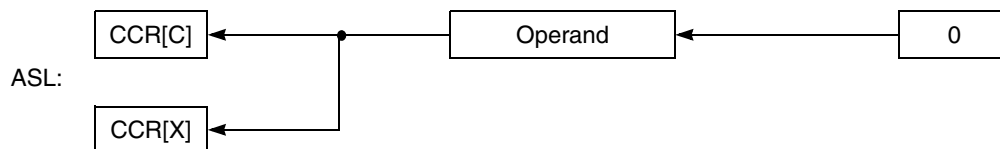

For ASR, the operand is shifted right; the number of positions shifted equals the shift count. Bits shifted out of the low-order bit go to both the carry and the extend bits; the sign bit (msb) is shifted into the high-order bit.

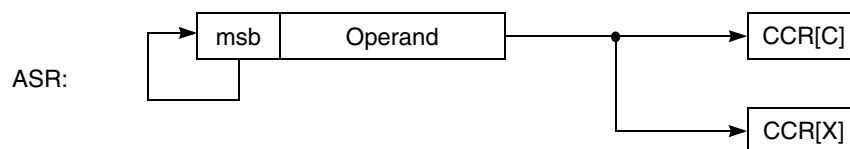

ASL, ASR

Arithmetic Shift

ASL, ASR

Condition Codes:

X	N	Z	V	C
*	*	*	0	*

- X Set according to the last bit shifted out of the operand; unaffected for a shift count of zero
- N Set if the msb of the result is set; cleared otherwise
- Z Set if the result is zero; cleared otherwise
- V Always cleared
- C Set according to the last bit shifted out of the operand; cleared for a shift count of zero

Note that CCR[V] is always cleared by ASL and ASR, unlike on the 68K family processors.

Instruction Format:

15	14	13	12	11	10	9	8	7	6	5	4	3	2	1	0	
1	1	1	0	Count or Register, Dy				dr	1	0	i/r	0	0	Register, Dx		

Instruction Fields:

- Count or Register field—Specifies shift count or register, Dy, that contains the shift count:
 - If i/r = 0, this field contains the shift count; values 1 – 7 represent counts of 1 – 7; a value of zero represents a count of 8.
 - If i/r = 1, this field specifies the data register, Dy, that contains the shift count (modulo 64).
- dr field—specifies the direction of the shift:
 - 0 shift right
 - 1 shift left
- i/r field
 - If i/r = 0, specifies immediate shift count
 - If i/r = 1, specifies register shift count
- Register field—Specifies a data register, Dx, to be shifted.

Bcc

Branch Conditionally

First appeared in ISA_A
.L First appeared in ISA_B

Bcc

Operation: If Condition True
Then $PC + d_n \rightarrow PC$

Assembler Syntax: Bcc.sz <label>

Attributes: Size = byte, word, longword (longword supported starting with ISA_B)

Description: If the condition is true, execution continues at (PC) + displacement. Branches can be forward, with a positive displacement, or backward, with a negative displacement. PC holds the address of the instruction word for the Bcc instruction, plus two. The displacement is a two's-complement integer that represents the relative distance in bytes from the current PC to the destination PC. If the 8-bit displacement field is 0, a 16-bit displacement (the word after the instruction) is used. If the 8-bit displacement field is 0xFF, the 32-bit displacement (longword after the instruction) is used. A branch to the next immediate instruction uses 16-bit displacement because the 8-bit displacement field is 0x00.

Condition code specifies one of the following tests, where C, N, V, and Z stand for the condition code bits CCR[C], CCR[N], CCR[V] and CCR[Z], respectively:

Code	Condition	Encod- ing	Test	Code	Condition	Encod- ing	Test
CC(HS)	Carry clear	0100	\bar{C}	LS	Lower or same	0011	$C Z$
CS(LO)	Carry set	0101	C	LT	Less than	1101	$N \& \bar{V} \bar{N} \& V$
EQ	Equal	0111	Z	MI	Minus	1011	N
GE	Greater or equal	1100	$N \& V \bar{N} \& \bar{V}$	NE	Not equal	0110	\bar{Z}
GT	Greater than	1110	$N \& V \& \bar{Z} \bar{N} \& \bar{V} \& \bar{Z}$	PL	Plus	1010	\bar{N}
HI	High	0010	$\bar{C} \& \bar{Z}$	VC	Overflow clear	1000	\bar{V}
LE	Less or equal	1111	$Z N \& \bar{V} \bar{N} \& V$	VS	Overflow set	1001	V

Condition Codes: Not affected

Bcc

Branch Conditionally

Bcc

Instruction Format:

15	14	13	12	11	10	9	8	7	6	5	4	3	2	1	0
0	1	1	0	Condition				8-bit displacement							
16-bit displacement if 8-bit displacement = 0x00															
32-bit displacement if 8-bit displacement = 0xFF															

Instruction Fields:

- Condition field—Binary encoding for one of the conditions listed in the table.
- 8-bit displacement field—Two's complement integer specifying the number of bytes between the branch and the next instruction to be executed if the condition is met.
- 16-bit displacement field—Used when the 8-bit displacement contains 0x00.
- 32-bit displacement field—Used when the 8-bit displacement contains 0xFF.

BCHG

Test a Bit and Change

BCHG

First appeared in ISA_A

Operation: \sim (<bit number> of Destination) \rightarrow CCR[Z];
 \sim (<bit number> of Destination) \rightarrow <bit number> of Destination

Assembler Syntax: BCHG.sz Dy,<ea>x
BCHG.sz #<data>,<ea>x

Attributes: Size = byte, longword

Description: Tests a bit in the destination operand and sets CCR[Z] appropriately, then inverts the specified bit in the destination. When the destination is a data register, any of the 32 bits can be specified by the modulo 32-bit number. When the destination is a memory location, the operation is a byte operation and the bit number is modulo 8. In all cases, bit zero refers to the least significant bit. The bit number for this operation may be specified in either of two ways:

1. Immediate—Bit number is specified in a second word of the instruction.
2. Register—Specified data register contains the bit number.

Condition Codes:

X	N	Z	V	C
—	—	*	—	—

X Not affected
N Not affected
Z Set if the bit tested is zero; cleared otherwise
V Not affected
C Not affected

Bit Number Static, Specified as Immediate Data:

	15	14	13	12	11	10	9	8	7	6	5	4	3	2	1	0
Instruction Format:	0	0	0	0	1	0	0	0	0	1	Destination Effective Address					
											Mode		Register			
	0	0	0	0	0	0	0	0	Bit Number							

Instruction Fields:

- Destination Effective Address field—Specifies the destination location <ea>x; use only those data alterable addressing modes listed in the following table. Note that longword is allowed only for the Dx mode, all others are byte only.

Addressing Mode	Mode	Register	Addressing Mode	Mode	Register
Dx	000	reg. number:Dx	(xxx).W	—	—
Ax	—	—	(xxx).L	—	—
(Ax)	010	reg. number:Ax	#<data>	—	—
(Ax) +	011	reg. number:Ax			
– (Ax)	100	reg. number:Ax			
(d ₁₆ ,Ax)	101	reg. number:Ax	(d ₁₆ ,PC)	—	—
(d ₈ ,Ax,Xi)	—	—	(d ₈ ,PC,Xi)	—	—

- Bit Number field—Specifies the bit number.

Bit Number Dynamic, Specified in a Register:

Instruction Format:	15	14	13	12	11	10	9	8	7	6	5	4	3	2	1	0
	0	0	0	0	Data Register, Dy				1	0	1	Destination Effective Address				
												Mode		Register		

Instruction Fields:

- Data Register field—Specifies the data register, Dy, that contains the bit number.
- Destination Effective Address field—Specifies the destination location, <ea>x; use only those data alterable addressing modes listed in the following table. Note that longword is allowed only for the Dx mode, all others are byte only.

Addressing Mode	Mode	Register	Addressing Mode	Mode	Register
Dx	000	reg. number:Dx	(xxx).W	111	000
Ax	—	—	(xxx).L	111	001
(Ax)	010	reg. number:Ax	#<data>	—	—
(Ax) +	011	reg. number:Ax			
– (Ax)	100	reg. number:Ax			
(d ₁₆ ,Ax)	101	reg. number:Ax	(d ₁₆ ,PC)	—	—
(d ₈ ,Ax,Xi)	110	reg. number:Ax	(d ₈ ,PC,Xi)	—	—

BCLR

Test a Bit and Clear

First appeared in ISA_A

BCLR

Operation: \sim (<bit number> of Destination) \rightarrow CCR[Z];
0 \rightarrow <bit number> of Destination

Assembler Syntax: BCLR.sz Dy,<ea>x
BCLR.sz #<data>,<ea>x

Attributes: Size = byte, longword

Description: Tests a bit in the destination operand and sets CCR[Z] appropriately, then clears the specified bit in the destination. When a data register is the destination, any of the 32 bits can be specified by a modulo 32-bit number. When a memory location is the destination, the operation is a byte operation and the bit number is modulo 8. In all cases, bit zero refers to the least significant bit. The bit number for this operation can be specified in either of two ways:

1. Immediate—Bit number is specified in a second word of the instruction.
2. Register—Specified data register contains the bit number.

Condition Codes:

X	N	Z	V	C
—	—	*	—	—

X Not affected
N Not affected
Z Set if the bit tested is zero; cleared otherwise
V Not affected
C Not affected

Bit Number Static, Specified as Immediate Data:

Instruction Format:

15	14	13	12	11	10	9	8	7	6	5	4	3	2	1	0
0	0	0	0	1	0	0	0	1	0	Destination Effective Address					
										Mode		Register			
0	0	0	0	0	0	0	0	Bit Number							

BCLR

Test a Bit and Clear

BCLR

Instruction Fields:

- Destination Effective Address field—Specifies the destination location <ea>x; use only those data alterable addressing modes listed in the following table. Note that longword is allowed only for the Dx mode, all others are byte only.

Addressing Mode	Mode	Register	Addressing Mode	Mode	Register
Dx	000	reg. number:Dx	(xxx).W	—	—
Ax	—	—	(xxx).L	—	—
(Ax)	010	reg. number:Ax	#<data>	—	—
(Ax) +	011	reg. number:Ax			
– (Ax)	100	reg. number:Ax			
(d ₁₆ ,Ax)	101	reg. number:Ax	(d ₁₆ ,PC)	—	—
(d ₈ ,Ax,Xi)	—	—	(d ₈ ,PC,Xi)	—	—

- Bit Number field—Specifies the bit number.

Bit Number Dynamic, Specified in a Register:

Instruction Format:

15	14	13	12	11	10	9	8	7	6	5	4	3	2	1	0
0	0	0	0	Data Register, Dy				1	1	0	Destination Effective Address				
										Mode		Register			

Instruction Fields:

- Data Register field—Specifies the data register, Dy, that contains the bit number.
- Destination Effective Address field—Specifies the destination location, <ea>x; use only those data alterable addressing modes listed in the following table. Note that longword is allowed only for the Dx mode, all others are byte only.

Addressing Mode	Mode	Register	Addressing Mode	Mode	Register
Dx	000	reg. number:Dx	(xxx).W	111	000
Ax	—	—	(xxx).L	111	001
(Ax)	010	reg. number:Ax	#<data>	—	—
(Ax) +	011	reg. number:Ax			
– (Ax)	100	reg. number:Ax			
(d ₁₆ ,Ax)	101	reg. number:Ax	(d ₁₆ ,PC)	—	—
(d ₈ ,Ax,Xi)	110	reg. number:Ax	(d ₈ ,PC,Xi)	—	—

BITREV

Bit Reverse Register

First appeared in ISA_C

BITREV

Operation: Bit Reversed Dx → Dx

Assembler Syntax: BITREV.L Dx

Attributes: Size = longword

Description: The contents of the destination data register are bit-reversed, i.e., new Dx[31] = old Dx[0], new Dx[30] = old Dx[1], ..., new Dx[0] = old Dx[31].

Condition Codes: Not affected

Instruction	15	14	13	12	11	10	9	8	7	6	5	4	3	2	1	0
Format:	0	0	0	0	0	0	0	0	1	1	0	0	0	Register, Dx		

Instruction Field:

Register field—Specifies the destination data register, Dx

BRA

Branch Always

First appeared in ISA_A
.L First appeared in ISA_B

BRA

Operation: $PC + d_n \rightarrow PC$

Assembler Syntax: BRA.sz <label>

Attributes: Size = byte, word, longword (longword supported starting with ISA_B)

Description: Program execution continues at location (PC) + displacement. Branches can be forward with a positive displacement, or backward with a negative displacement. The PC contains the address of the instruction word of the BRA instruction plus two. The displacement is a two's complement integer that represents the relative distance in bytes from the current PC to the destination PC. If the 8-bit displacement field in the instruction word is 0, a 16-bit displacement (the word immediately following the instruction) is used. If the 8-bit displacement field in the instruction word is all ones (0xFF), the 32-bit displacement (longword immediately following the instruction) is used. A branch to the next immediate instruction automatically uses the 16-bit displacement format because the 8-bit displacement field contains 0x00 (zero offset).

Condition codes: Not affected

Instruction Format:

15	14	13	12	11	10	9	8	7	6	5	4	3	2	1	0
0	1	1	0	0	0	0	0	8-bit displacement							
16-bit displacement if 8-bit displacement = 0x00															
32-bit displacement if 8-bit displacement = 0xFF															

Instruction Fields:

- 8-bit displacement field—Two's complement integer specifying the number of bytes between the branch instruction and the next instruction to be executed.
- 16-bit displacement field—Used for displacement when the 8-bit displacement contains 0x00.
- 32-bit displacement field—Used for displacement when the 8-bit displacement contains 0xFF.

BSET

Test a Bit and Set First appeared in ISA_A

BSET

Operation: ~ (<bit number> of Destination) → CCR[Z];
1 → <bit number> of Destination

Assembler Syntax: BSET.sz Dy,<ea>x
BSET.sz #<data >,<ea>x

Attributes: Size = byte, longword

Description: Tests a bit in the destination operand and sets CCR[Z] appropriately, then sets the specified bit in the destination operand. When a data register is the destination, any of the 32 bits can be specified by a modulo 32-bit number. When a memory location is the destination, the operation is a byte operation and the bit number is modulo 8. In all cases, bit 0 refers to the least significant bit. The bit number for this operation can be specified in either of two ways:

1. Immediate—Bit number is specified in the second word of the instruction.
2. Register—Specified data register contains the bit number.

Condition Codes:

X	N	Z	V	C
—	—	*	—	—

X Not affected
 N Not affected
 Z Set if the bit tested is zero; cleared otherwise
 V Not affected
 C Not affected

Bit Number Static, Specified as Immediate Data:

	15	14	13	12	11	10	9	8	7	6	5	4	3	2	1	0
Instruction Format:	0	0	0	0	1	0	0	0	1	1	Destination Effective Address					
											Mode		Register			
	0	0	0	0	0	0	0	0	Bit Number							

BSET

Test a Bit and Set

BSET

Instruction Fields:

- Destination Effective Address field—Specifies the destination location <ea>x; use only those data alterable addressing modes listed in the following table. Note that longword is allowed only for the Dx mode; all others are byte only.

Addressing Mode	Mode	Register	Addressing Mode	Mode	Register
Dx	000	reg. number:Dx	(xxx).W	—	—
Ax	—	—	(xxx).L	—	—
(Ax)	010	reg. number:Ax	#<data>	—	—
(Ax) +	011	reg. number:Ax			
– (Ax)	100	reg. number:Ax			
(d ₁₆ ,Ax)	101	reg. number:Ax	(d ₁₆ ,PC)	—	—
(d ₈ ,Ax,Xi)	—	—	(d ₈ ,PC,Xi)	—	—

- Bit Number field—Specifies the bit number.

Bit Number Dynamic, Specified in a Register:

Instruction Format:

15	14	13	12	11	10	9	8	7	6	5	4	3	2	1	0
0	0	0	0	Data Register, Dy				1	1	1	Destination Effective Address				
										Mode		Register			

Instruction Fields:

- Data Register field—Specifies the data register, Dy, that contains the bit number.
- Destination Effective Address field—Specifies the destination location, <ea>x; use only those data alterable addressing modes listed in the following table. Note that longword is allowed only for the Dx mode, all others are byte only.

Addressing Mode	Mode	Register	Addressing Mode	Mode	Register
Dx	000	reg. number:Dx	(xxx).W	111	000
Ax	—	—	(xxx).L	111	001
(Ax)	010	reg. number:Ax	#<data>	—	—
(Ax) +	011	reg. number:Ax			
– (Ax)	100	reg. number:Ax			
(d ₁₆ ,Ax)	101	reg. number:Ax	(d ₁₆ ,PC)	—	—
(d ₈ ,Ax,Xi)	110	reg. number:Ax	(d ₈ ,PC,Xi)	—	—

BSR

Branch to Subroutine

BSR

First appeared in ISA_A
.L First appeared in ISA_B

Operation: $SP - 4 \rightarrow SP$; $nextPC \rightarrow (SP)$; $PC + d_n \rightarrow PC$

Assembler Syntax: `BSR.sz <label>`

Attributes: Size = byte, word, longword (longword supported starting with ISA_B)

Description: Pushes the longword address of the instruction immediately following the BSR instruction onto the system stack. Branches can be forward with a positive displacement, or backward with a negative displacement. The PC contains the address of the instruction word, plus two. Program execution then continues at location (PC) + displacement. The displacement is a two's complement integer that represents the relative distance in bytes from the current PC to the destination PC. If the 8-bit displacement field in the instruction word is 0, a 16-bit displacement (the word immediately following the instruction) is used. If the 8-bit displacement field in the instruction word is all ones (0xFF), the 32-bit displacement (longword immediately following the instruction) is used. A branch to the next immediate instruction automatically uses the 16-bit displacement format because the 8-bit displacement field contains 0x00 (zero offset).

Condition Codes: Not affected

Instruction Format:		15	14	13	12	11	10	9	8	7	6	5	4	3	2	1	0
		0	1	1	0	0	0	0	1	8-bit displacement							
16-bit displacement if 8-bit displacement = 0x00																	
32-bit displacement if 8-bit displacement = 0xFF																	

Instruction Fields:

- 8-bit displacement field—Two's complement integer specifying the number of bytes between the branch instruction and the next instruction to be executed.
- 16-bit displacement field—Used for displacement when the 8-bit displacement contains 0x00.
- 32-bit displacement field—Used for displacement when the 8-bit displacement contains 0xFF.

BTST

Test a Bit First appeared in ISA_A

BTST

Operation: \sim (<bit number> of Destination) \rightarrow CCR[Z]

Assembler Syntax: BTST.sz Dy,<ea>x
BTST.sz #<data>,<ea>x

Attributes: Size = byte, longword

Description: Tests a bit in the destination operand and sets CCR[Z] appropriately. When a data register is the destination, any of the 32 bits can be specified by a modulo 32 bit number. When a memory location is the destination, the operation is a byte operation and the bit number is modulo 8. In all cases, bit 0 refers to the least significant bit. The bit number for this operation can be specified in either of two ways:

1. Immediate—Bit number is specified in a second word of the instruction.
2. Register—Specified data register contains the bit number.

Condition Codes:

X	N	Z	V	C
—	—	*	—	—

X Not affected
 N Not affected
 Z Set if the bit tested is zero; cleared otherwise
 V Not affected
 C Not affected

Bit Number Static, Specified as Immediate Data:

Instruction Format:

	15	14	13	12	11	10	9	8	7	6	5	4	3	2	1	0		
	0	0	0	0	1	0	0	0	0	0	Destination Effective Address							
									Mode		Register							
	0	0	0	0	0	0	0	0	Bit Number									

Instruction Fields:

- Destination Effective Address field—Specifies the destination location <ea>x; use only those data alterable addressing modes listed in the following table. Note that longword is allowed only for the Dx mode, all others are byte only.

Addressing Mode	Mode	Register	Addressing Mode	Mode	Register
Dx	000	reg. number:Dx	(xxx).W	—	—
Ax	—	—	(xxx).L	—	—
(Ax)	010	reg. number:Ax	#<data>	—	—
(Ax) +	011	reg. number:Ax			
– (Ax)	100	reg. number:Ax			
(d ₁₆ ,Ax)	101	reg. number:Ax	(d ₁₆ ,PC)	—	—
(d ₈ ,Ax,Xi)	—	—	(d ₈ ,PC,Xi)	—	—

BTST

Test a Bit

BTST

Instruction Fields (continued):

- Bit Number field—Specifies the bit number.

Bit Number Dynamic, Specified in a Register:

Instruction Format:	15	14	13	12	11	10	9	8	7	6	5	4	3	2	1	0	
	0	0	0	0	Data Register, Dy				1	0	0	Destination Effective Address					
											Mode			Register			

Instruction Fields:

- Data Register field—Specifies the data register, Dy, that contains the bit number.
- Destination Effective Address field—Specifies the destination location, <ea>x; use only those data alterable addressing modes listed in the following table. Note that longword is allowed only for the Dx mode, all others are byte only.

Addressing Mode	Mode	Register	Addressing Mode	Mode	Register
Dx	000	reg. number:Dx	(xxx).W	111	000
Ax	—	—	(xxx).L	111	001
(Ax)	010	reg. number:Ax	#<data>	—	—
(Ax) +	011	reg. number:Ax			
– (Ax)	100	reg. number:Ax			
(d ₁₆ ,Ax)	101	reg. number:Ax	(d ₁₆ ,PC)	111	010
(d ₈ ,Ax,Xi)	110	reg. number:Ax	(d ₈ ,PC,Xi)	111	011

BYTEREV

Byte Reverse Register
First appeared in ISA_C

BYTEREV

Operation: Byte Reversed Dx → Dx

Assembler Syntax: BYTEREV.L Dx

Attributes: Size = longword

Description: The contents of the destination data register are byte-reversed as defined below:

Table 1:

new Dx[31:24]	= old Dx[7:0]
new Dx[23:16]	= old Dx[15:8]
new Dx[15:8]	= old Dx[23:16]
new Dx[7:0]	= old Dx[31:24]

Condition Codes: Not affected

Instruction	15	14	13	12	11	10	9	8	7	6	5	4	3	2	1	0
Format:	0	0	0	0	0	0	1	0	1	1	0	0	0	Register, Dx		

Instruction Field:

- Register field—Specifies the destination data register, Dx.

CLR

Clear an Operand First appeared in ISA_A

CLR

Operation: 0 → Destination

Assembler Syntax: CLR.sz <ea>x

Attributes: Size = byte, word, longword

Description: Clears the destination operand to 0. The size of the operation may be specified as byte, word, or longword.

Condition Codes:

X	N	Z	V	C
—	0	1	0	0

X Not affected
 N Always cleared
 Z Always set
 V Always cleared
 C Always cleared

Instruction Format:

	15	14	13	12	11	10	9	8	7	6	5	4	3	2	1	0
	0	1	0	0	0	0	1	0	Size		Destination Effective Address					
											Mode			Register		

Instruction Fields:

- Size field—Specifies the size of the operation
 - 00 byte operation
 - 01 word operation
 - 10 longword operation
 - 11 reserved
- Effective Address field—Specifies the destination location, <ea>x; use only those data alterable addressing modes listed in the following table:

Addressing Mode	Mode	Register	Addressing Mode	Mode	Register
Dx	000	reg. number:Dx	(xxx).W	111	000
Ax	—	—	(xxx).L	111	001
(Ax)	010	reg. number:Ax	#<data>	—	—
(Ax) +	011	reg. number:Ax			
– (Ax)	100	reg. number:Ax			
(d ₁₆ ,Ax)	101	reg. number:Ax	(d ₁₆ ,PC)	—	—
(d ₈ ,Ax,Xi)	110	reg. number:Ax	(d ₈ ,PC,Xi)	—	—

CMP

Compare

CMP

First appeared in ISA_A
.B and .W First appeared in ISA_B

Operation: Destination – Source → cc

Assembler Syntax: CMP.sz <ea>y,Dx

Attributes: Size = byte, word, longword (byte, word supported starting with ISA_B)

Description: Subtracts the source operand from the destination operand in the data register and sets condition codes according to the result; the data register is unchanged. The operation size may be a byte, word, or longword. CMPA is used when the destination is an address register; CMPI is used when the source is immediate data.

Condition Codes:	X	N	Z	V	C	X	Not affected
	—	*	*	*	*	N	Set if the result is negative; cleared otherwise
						Z	Set if the result is zero; cleared otherwise
						V	Set if an overflow occurs; cleared otherwise
						C	Set if a borrow occurs; cleared otherwise

Instruction Format:	15	14	13	12	11	10	9	8	7	6	5	4	3	2	1	0	
	1	0	1	1	Destination Register, Dx			Opmode			Source Effective Address						
												Mode			Register		

Instruction Fields:

- Register field—Specifies the destination register, Dx.
- Opmode field:

Byte	Word	Longword	Operation
000	001	010	Dx - <ea>y

- Source Effective Address field— Specifies the source operand, <ea>y; use addressing modes listed in the following table:

Addressing Mode	Mode	Register	Addressing Mode	Mode	Register
Dy	000	reg. number:Dy	(xxx).W	111	000
Ay	001	reg. number:Ay	(xxx).L	111	001
(Ay)	010	reg. number:Ay	#<data>	111	100
(Ay) +	011	reg. number:Ay			
– (Ay)	100	reg. number:Ay			
(d ₁₆ ,Ay)	101	reg. number:Ay	(d ₁₆ ,PC)	111	010
(d ₈ ,Ay,Xi)	110	reg. number:Ay	(d ₈ ,PC,Xi)	111	011

CMPA

Compare Address
 First appeared in ISA_A
 .W First appeared in ISA_B

CMPA

Operation: Destination – Source → cc

Assembler Syntax: CMPA.sz <ea>y, Ax

Attributes: Size = word, longword (word supported starting with ISA_B)

Description: Operates similarly to CMP, but is used when the destination register is an address register rather than a data register. The operation size can be word or longword. Word-length source operands are sign-extended to 32 bits for comparison.

Condition Codes:

X	N	Z	V	C	X Not affected
—	*	*	*	*	N Set if the result is negative; cleared otherwise
					Z Set if the result is zero; cleared otherwise
					V Set if an overflow occurs; cleared otherwise
					C Set if a borrow occurs; cleared otherwise

Instruction Format:

15	14	13	12	11	10	9	8	7	6	5	4	3	2	1	0
1	0	1	1	Address Register, Ax				Opmode			Source Effective Address				
										Mode		Register			

Instruction Fields:

- Address Register field—Specifies the destination register, Ax.
- Opmode field:

Byte	Word	Longword	Operation
—	011	111	Ax - <ea>y

- Source Effective Address field specifies the source operand, <ea>y; use addressing modes in the following table:

Addressing Mode	Mode	Register	Addressing Mode	Mode	Register
Dy	000	reg. number:Dy	(xxx).W	111	000
Ay	001	reg. number:Ay	(xxx).L	111	001
(Ay)	010	reg. number:Ay	#<data>	111	100
(Ay) +	011	reg. number:Ay			
– (Ay)	100	reg. number:Ay			
(d ₁₆ ,Ay)	101	reg. number:Ay	(d ₁₆ ,PC)	111	010
(d ₈ ,Ay,Xi)	110	reg. number:Ay	(d ₈ ,PC,Xi)	111	011

CMPI

Compare Immediate

First appeared in ISA_A
.B and .W First appeared in ISA_B

CMPI

Operation: Destination – Immediate Data → cc

Assembler Syntax: CMPI.sz #<data>,Dx

Attributes: Size = byte, word, longword (byte, word supported starting with ISA_B)

Description: Operates similarly to CMP, but is used when the source operand is immediate data. The operation size can be byte, word, or longword. The size of the immediate data matches the operation size. Note that if size = byte, the immediate data is contained in bits [7:0] of the single extension word. If size = word, the immediate data is contained in the single extension word, bits [15:0]. If size = longword, the immediate data is contained in the two extension words, with the first extension word, bits [15:0], containing the upper word, and the second extension word, bits [15:0], containing the lower word.

Condition Codes:	X	N	Z	V	C	X	Not affected
	—	*	*	*	*	N	Set if the result is negative; cleared otherwise
						Z	Set if the result is zero; cleared otherwise
						V	Set if an overflow occurs; cleared otherwise
						C	Set if a borrow occurs; cleared otherwise

Instruction Format:	15	14	13	12	11	10	9	8	7	6	5	4	3	2	1	0
	0	0	0	0	1	1	0	0	Size		0	0	0	Register, Dx		
	Upper Word of Immediate Data															
	Lower Word of Immediate Data															

Instruction Fields:

- Register field—Specifies the destination register, Dx.
- Size field—Specifies the size of the operation
 - 00 byte operation
 - 01 word operation
 - 10 longword operation
 - 11 reserved

DIVS

Signed Divide

DIVS

First appeared in ISA_A

Not implemented in MCF5202, MCF5204 and MCF5206

Operation: Destination/Source → Destination

Assembler Syntax: DIVS.W <ea>y,Dx 32-bit Dx/16-bit <ea>y Æ (16r:16q) in Dx
DIVS.L <ea>y,Dx 32-bit Dx/32-bit <ea>y Æ 32q in Dx
where q indicates the quotient, and r indicates the remainder

Attributes: Size = word, longword

Description: Divide the signed destination operand by the signed source and store the signed result in the destination. For a word-sized operation, the destination operand is a longword and the source is a word; the 16-bit quotient is in the lower word and the 16-bit remainder is in the upper word of the destination. Note that the sign of the remainder is the same as the sign of the dividend. For a longword-sized operation, the destination and source operands are both longwords; the 32-bit quotient is stored in the destination. To determine the remainder on a longword-sized operation, use the REMS instruction.

An attempt to divide by zero results in a divide-by-zero exception and no registers are affected. The resulting exception stack frame points to the offending divide opcode. If overflow is detected, the destination register is unaffected. An overflow occurs if the quotient is larger than a 16-bit (.W) or 32-bit (.L) signed integer.

Condition Codes:	X	N	Z	V	C	X	Not affected
	—	*	*	*	0	N	Cleared if overflow is detected; otherwise set if the quotient is negative, cleared if positive
						Z	Cleared if overflow is detected; otherwise set if the quotient is zero, cleared if nonzero
						V	Set if an overflow occurs; cleared otherwise
						C	Always cleared

Instruction Format: (Word)	15	14	13	12	11	10	9	8	7	6	5	4	3	2	1	0	
	1	0	0	0	Register, Dx				1	1	1	Source Effective Address					
												Mode		Register			

DIVS

Signed Divide First appeared in ISA_A

DIVS

Instruction Fields (Word):

- Register field—Specifies the destination register, Dx.
- Source Effective Address field specifies the source operand, <ea>y; use addressing modes in the following table:

Addressing Mode	Mode	Register	Addressing Mode	Mode	Register
Dy	000	reg. number:Dy	(xxx).W	111	000
Ay	—	—	(xxx).L	111	001
(Ay)	010	reg. number:Ay	#<data>	111	100
(Ay) +	011	reg. number:Ay			
– (Ay)	100	reg. number:Ay			
(d ₁₆ ,Ay)	101	reg. number:Ay	(d ₁₆ ,PC)	111	010
(d ₈ ,Ay,Xi)	110	reg. number:Ay	(d ₈ ,PC,Xi)	111	011

Instruction Format: (Longword)

15	14	13	12	11	10	9	8	7	6	5	4	3	2	1	0
0	1	0	0	1	1	0	0	0	1	Source Effective Address					
								Mode		Register					
0	Register, Dx			1	0	0	0	0	0	0	0	Register, Dx			

Instruction Fields (Longword):

- Register field—Specifies the destination register, Dx. Note that this field appears twice in the instruction format.
- Source Effective Address field— Specifies the source operand, <ea>y; use addressing modes in the following table:

Addressing Mode	Mode	Register	Addressing Mode	Mode	Register
Dy	000	reg. number:Dy	(xxx).W	—	—
Ay	—	—	(xxx).L	—	—
(Ay)	010	reg. number:Ay	#<data>	—	—
(Ay) +	011	reg. number:Ay			
– (Ay)	100	reg. number:Ay			
(d ₁₆ ,Ay)	101	reg. number:Ay	(d ₁₆ ,PC)	—	—
(d ₈ ,Ay,Xi)	—	—	(d ₈ ,PC,Xi)	—	—

DIVU

Unsigned Divide

DIVU

First appeared in ISA_A

Not implemented in MCF5202, MCF5204 and MCF5206

Operation: Destination/Source → Destination

Assembler Syntax: DIVU.W <ea>y,Dx 32-bit Dx/16-bit <ea>y Æ (16r:16q) in Dx
DIVU.L <ea>y,Dx 32-bit Dx/32-bit <ea>y Æ 32q in Dx
where q indicates the quotient, and r indicates the remainder

Attributes: Size = word, longword

Description: Divide the unsigned destination operand by the unsigned source and store the unsigned result in the destination. For a word-sized operation, the destination operand is a longword and the source is a word; the 16-bit quotient is in the lower word and the 16-bit remainder is in the upper word of the destination. For a longword-sized operation, the destination and source operands are both longwords; the 32-bit quotient is stored in the destination. To determine the remainder on a longword-sized operation, use the REMU instruction.

An attempt to divide by zero results in a divide-by-zero exception and no registers are affected. The resulting exception stack frame points to the offending divide opcode. If overflow is detected, the destination register is unaffected. An overflow occurs if the quotient is larger than a 16-bit (.W) or 32-bit (.L) unsigned integer.

Condition Codes:	X	N	Z	V	C	X	Not affected
	—	*	*	*	0	N	Cleared if overflow is detected; otherwise set if the quotient is negative, cleared if positive
						Z	Cleared if overflow is detected; otherwise set if the quotient is zero, cleared if nonzero
						V	Set if an overflow occurs; cleared otherwise
						C	Always cleared

Instruction Format: (Word)	15	14	13	12	11	10	9	8	7	6	5	4	3	2	1	0
	1	0	0	0	Register, Dx			0	1	1	Source Effective Address					
										Mode			Register			

DIVU

Unsigned Divide

DIVU

Instruction Fields (Word):

- Register field—Specifies the destination register, Dx.
- Source Effective Address field specifies the source operand, <ea>y; use addressing modes in the following table:

Addressing Mode	Mode	Register	Addressing Mode	Mode	Register
Dy	000	reg. number:Dy	(xxx).W	111	000
Ay	—	—	(xxx).L	111	001
(Ay)	010	reg. number:Ay	#<data>	111	100
(Ay) +	011	reg. number:Ay			
– (Ay)	100	reg. number:Ay			
(d ₁₆ ,Ay)	101	reg. number:Ay	(d ₁₆ ,PC)	111	010
(d ₈ ,Ay,Xi)	110	reg. number:Ay	(d ₈ ,PC,Xi)	111	011

Instruction Format: (Longword)

15	14	13	12	11	10	9	8	7	6	5	4	3	2	1	0
0	1	0	0	1	1	0	0	0	1	Source Effective Address					
								Mode		Register					
0	Register, Dx			0	0	0	0	0	0	0	0	0	Register, Dx		

Instruction Fields (Longword):

- Register field—Specifies the destination register, Dx. Note that this field appears twice in the instruction format.
- Source Effective Address field— Specifies the source operand, <ea>y; use addressing modes in the following table:

Addressing Mode	Mode	Register	Addressing Mode	Mode	Register
Dy	000	reg. number:Dy	(xxx).W	—	—
Ay	—	—	(xxx).L	—	—
(Ay)	010	reg. number:Ay	#<data>	—	—
(Ay) +	011	reg. number:Ay			
– (Ay)	100	reg. number:Ay			
(d ₁₆ ,Ay)	101	reg. number:Ay	(d ₁₆ ,PC)	—	—
(d ₈ ,Ay,Xi)	—	—	(d ₈ ,PC,Xi)	—	—

EOR

Exclusive-OR Logical First appeared in ISA_A

EOR

Operation: Source \wedge Destination \rightarrow Destination

Assembler Syntax: EOR.L Dy,<ea>x

Attributes: Size = longword

Description: Performs an exclusive-OR operation on the destination operand using the source operand and stores the result in the destination location. The size of the operation is specified as a longword. The source operand must be a data register. The destination operand is specified in the effective address field. EORI is used when the source is immediate data.

Condition Codes:	X	N	Z	V	C	X	Not affected
	—	*	*	0	0	N	Set if the msb of the result is set; cleared otherwise
						Z	Set if the result is zero; cleared otherwise
						V	Always cleared
						C	Always cleared

Instruction Format:	15	14	13	12	11	10	9	8	7	6	5	4	3	2	1	0
	1	0	1	1	Register, Dy				1	1	0	Destination Effective Address				
												Mode		Register		

Instruction Fields:

- Register field—Specifies any of the 8 data registers for the source operand, Dy.
- Destination Effective Address field—Specifies the destination operand, <ea>x; use addressing modes in the following table:

Addressing Mode	Mode	Register	Addressing Mode	Mode	Register
Dx	000	reg. number:Dx	(xxx).W	111	000
Ax	—	—	(xxx).L	111	001
(Ax)	010	reg. number:Ax	#<data>	—	—
(Ax) +	011	reg. number:Ax			
– (Ax)	100	reg. number:Ax			
(d ₁₆ ,Ax)	101	reg. number:Ax	(d ₁₆ ,PC)	—	—
(d ₈ ,Ax,Xi)	110	reg. number:Ax	(d ₈ ,PC,Xi)	—	—

EORI

Exclusive-OR Immediate

First appeared in ISA_A

EORI

Operation: Immediate Data ^ Destination → Destination

Assembler Syntax: EORI.L #<data>,Dx

Attributes: Size = longword

Description: Performs an exclusive-OR operation on the destination operand using the immediate data and the destination operand and stores the result in the destination data register, Dx. The size of the operation is specified as a longword. Note that the immediate data is contained in the two extension words, with the first extension word, bits [15:0], containing the upper word, and the second extension word, bits [15:0], containing the lower word.

Condition Codes:	X	N	Z	V	C	X	Not affected
	—	*	*	0	0	N	Set if the msb of the result is set; cleared otherwise
						Z	Set if the result is zero; cleared otherwise
						V	Always cleared
						C	Always cleared

Instruction Format:	15	14	13	12	11	10	9	8	7	6	5	4	3	2	1	0
	0	0	0	0	1	0	1	0	1	0	0	0	0			Register, Dx
	Upper Word of Immediate Data															
	Lower Word of Immediate Data															

Instruction Fields:

- Register field - Destination data register, Dx.

EXT, EXTB

Sign-Extend
First appeared in ISA_A

EXT, EXTB

Operation: Destination Sign-Extended → Destination

Assembler Syntax: EXT.W Dx extend byte to word
 EXT.L Dx extend word to longword
 EXTB.L Dx extend byte to longword

Attributes: Size = word, longword

Description: Extends a byte in a data register, Dx, to a word or a longword, or a word in a data register to a longword, by replicating the sign bit to the left. When the EXT operation extends a byte to a word, bit 7 of the designated data register is copied to bits 15 – 8 of the data register. When the EXT operation extends a word to a longword, bit 15 of the designated data register is copied to bits 31 – 16 of the data register. The EXTB form copies bit 7 of the designated register to bits 31 – 8 of the data register.

Condition Codes:	X	N	Z	V	C	X Not affected
	—	*	*	0	0	N Set if result is negative; cleared otherwise
						Z Set if the result is zero; cleared otherwise
						V Always cleared
						C Always cleared

Instruction Format:	15	14	13	12	11	10	9	8	7	6	5	4	3	2	1	0
	0	1	0	0	1	0	0	Opmode			0	0	0	Register, Dx		

Instruction Fields:

- Opmode field—Specifies the size of the sign-extension operation:
 - 010 sign-extend low-order byte of data register to word
 - 011 sign-extend low-order word of data register to longword
 - 111 sign-extend low-order byte of data register to longword
- Register field—Specifies the data register, Dx, to be sign-extended.

FF1

Find First One in Register

FF1

First appeared in ISA_C

Operation: Bit Offset of the First Logical One in Register → Destination

Assembler Syntax: FF1.L Dx

Attributes: Size = longword

Description: The data register, Dx, is scanned, beginning from the most-significant bit (Dx[31]) and ending with the least-significant bit (Dx[0]), searching for the first set bit. The data register is then loaded with the offset count from bit 31 where the first set bit appears, as shown below. If the source data is zero, then an offset of 32 is returned.

Table 0–1

Old Dx[31:0]	New Dx[31:0]
0x8000 0000	0x0000 0000
0x4000 0000	0x0000 0001
0x2000 0000	0x0000 0002
...	...
0x0000 0002	0x0000 001E
0x0000 0001	0x0000 001F
0x0000 0000	0x0000 0020

Condition Codes:

X	N	Z	V	C
—	*	*	0	0

- X Not affected
- N Set if the msb of the source operand is set; cleared otherwise
- Z Set if the source operand is zero; cleared otherwise
- V Always cleared
- C Always cleared

Instruction Format:

15	14	13	12	11	10	9	8	7	6	5	4	3	2	1	0
0	0	0	0	0	1	0	0	1	1	0	0	0	Destination Register, Dx		

ILLEGAL

Take Illegal Instruction Trap First appeared in ISA_A

ILLEGAL

Operation: SP - 4 → SP; PC → (SP) (forcing stack to be longword aligned)
SP - 2 → SP; SR → (SP)
SP - 2 → SP; Vector Offset → (SP)
(VBR + 0x10) → PC

Assembler Syntax: ILLEGAL

Attributes: Unsized

Description: Execution of this instruction causes an illegal instruction exception. The opcode for ILLEGAL is 0x4AFC.

Starting with ISA_B (for devices which have an MMU), the Supervisor Stack Pointer (SSP) is used for this instruction.

Condition Codes: Not affected.

Instruction Format:	15	14	13	12	11	10	9	8	7	6	5	4	3	2	1	0
	0	1	0	0	1	0	1	0	1	1	1	1	1	1	0	0

JMP

Jump

JMP

First appeared in ISA_A

Operation: Destination Address → PC

Assembler Syntax: JMP <ea>y

Attributes: Unsized

Description: Program execution continues at the effective address specified by the instruction.

Condition Codes: Not affected.

Instruction Format:	15	14	13	12	11	10	9	8	7	6	5	4	3	2	1	0
	0	1	0	0	1	1	1	0	1	1	Source Effective Address					
											Mode		Register			

Instruction Field:

- Source Effective Address field—Specifies the address of the next instruction, <ea>y; use the control addressing modes in the following table:

Addressing Mode	Mode	Register	Addressing Mode	Mode	Register
Dy	—	—	(xxx).W	111	000
Ay	—	—	(xxx).L	111	001
(Ay)	010	reg. number: Ay	#<data>	—	—
(Ay) +	—	—			
– (Ay)	—	—			
(d ₁₆ ,Ay)	101	reg. number: Ay	(d ₁₆ ,PC)	111	010
(d ₈ ,Ay,Xi)	110	reg. number: Ay	(d ₈ ,PC,Xi)	111	011

JSR

Jump to Subroutine First appeared in ISA_A

JSR

Operation: SP – 4 → SP; nextPC → (SP); Destination Address → PC

Assembler Syntax: JSR <ea>y

Attributes: Unsized

Description: Pushes the longword address of the instruction immediately following the JSR instruction onto the system stack. Program execution then continues at the address specified in the instruction.

Condition Codes: Not affected

Instruction Format:	15	14	13	12	11	10	9	8	7	6	5	4	3	2	1	0
	0	1	0	0	1	1	1	0	1	0	Source Effective Address					
											Mode			Register		

Instruction Field:

- Source Effective Address field—Specifies the address of the next instruction, <ea>y; use the control addressing modes in the following table:

Addressing Mode	Mode	Register	Addressing Mode	Mode	Register
Dy	—	—	(xxx).W	111	000
Ay	—	—	(xxx).L	111	001
(Ay)	010	reg. number: Ay	#<data>	—	—
(Ay) +	—	—			
– (Ay)	—	—			
(d ₁₆ , Ay)	101	reg. number: Ay	(d ₁₆ , PC)	111	010
(d ₈ , Ay, Xi)	110	reg. number: Ay	(d ₈ , PC, Xi)	111	011

LEA

Load Effective Address

First appeared in ISA_A

LEA

Operation: $\langle ea \rangle y \rightarrow Ax$

Assembler Syntax: LEA.L $\langle ea \rangle y, Ax$

Attributes: Size = longword

Description: Loads the effective address into the specified address register, Ax.

Condition Codes: Not affected

Instruction Format:	15	14	13	12	11	10	9	8	7	6	5	4	3	2	1	0	
	0	1	0	0	Register, Ax			1	1	1	Source Effective Address						
												Mode		Register			

Instruction Fields:

- Register field—Specifies the address register, Ax, to be updated with the effective address.
- Source Effective Address field—Specifies the address to be loaded into the destination address register; use the control addressing modes in the following table:

Addressing Mode	Mode	Register	Addressing Mode	Mode	Register
Dy	—	—	(xxx).W	111	000
Ay	—	—	(xxx).L	111	001
(Ay)	010	reg. number: Ay	#<data>	—	—
(Ay) +	—	—			
– (Ay)	—	—			
(d ₁₆ , Ay)	101	reg. number: Ay	(d ₁₆ , PC)	111	010
(d ₈ , Ay, Xi)	110	reg. number: Ay	(d ₈ , PC, Xi)	111	011

LINK

Link and Allocate

First appeared in ISA_A

LINK

Operation: $SP - 4 \rightarrow SP; Ay \rightarrow (SP); SP \rightarrow Ay; SP + d_n \rightarrow SP$

Assembler Syntax: LINK.W Ay,#<displacement>

Attributes: Size = Word

Description: Pushes the contents of the specified address register onto the stack. Then loads the updated stack pointer into the address register. Finally, adds the displacement value to the stack pointer. The displacement is the sign-extended word following the operation word. Note that although LINK is a word-sized instruction, most assemblers also support an unsized LINK.

Condition Codes: Not affected

Instruction Format:	15	14	13	12	11	10	9	8	7	6	5	4	3	2	1	0
	0	1	0	0	1	1	1	0	0	1	0	1	0	Register, Ay		
	Word Displacement															

Instruction Fields:

- Register field—Specifies the address register, Ay, for the link.
- Displacement field—Specifies the two's complement integer to be added to the stack pointer.

LSL, LSR

Logical Shift
First appeared in ISA_A

LSL, LSR

Operation: Destination Shifted By Count → Destination

Assembler Syntax: LSd.L Dy,Dx
LSd.L #<data>,Dx
where d is direction, L or R

Attributes: Size = longword

Description: Shifts the bits of the destination operand, Dx, in the direction (L or R) specified. The size of the operand is a longword. CCR[C] receives the last bit shifted out of the operand. The shift count is the number of bit positions to shift the destination register and may be specified in two different ways:

1. Immediate—The shift count is specified in the instruction (shift range is 1 – 8).
2. Register—The shift count is the value in the data register, Dy, specified in the instruction (modulo 64).

The LSL instruction shifts the operand to the left the number of positions specified as the shift count. Bits shifted out of the high-order bit go to both the carry and the extend bits; zeros are shifted into the low-order bit.

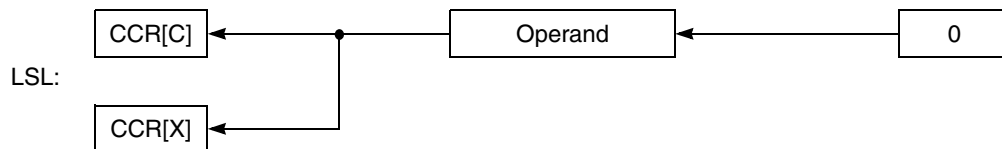

The LSR instruction shifts the operand to the right the number of positions specified as the shift count. Bits shifted out of the low-order bit go to both the carry and the extend bits; zeros are shifted into the high-order bit.

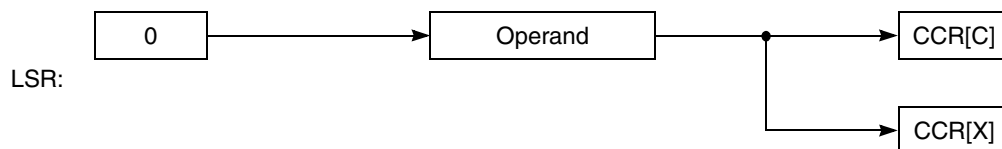

LSL, LSR

Logical Shift

LSL, LSR

Condition Codes:

X	N	Z	V	C
*	*	*	0	*

- X Set according to the last bit shifted out of the operand; unaffected for a shift count of zero
- N Set if result is negative; cleared otherwise
- Z Set if the result is zero; cleared otherwise
- V Always cleared
- C Set according to the last bit shifted out of the operand; cleared for a shift count of zero

Instruction Format:

15	14	13	12	11	10	9	8	7	6	5	4	3	2	1	0	
1	1	1	0	Count or Register, Dy				dr	1	0	i/r	0	1	Register, Dx		

Instruction Fields:

- Count/Register field
 - If $i/r = 0$, this field contains the shift count; values 1 – 7 represent shifts of 1 – 7; value of 0 specifies shift count of 8
 - If $i/r = 1$, data register, Dy, specified in this field contains shift count (modulo 64)
- dr field—Specifies the direction of the shift:
 - 0 shift right
 - 1 shift left
- i/r field
 - 0 immediate shift count
 - 1 register shift count
- Register field—Specifies a data register, Dx, to be shifted.

MOV3Q

Move 3-Bit Data Quick
First appeared in ISA_B

MOV3Q

Operation: 3-bit Immediate Data → Destination

Assembler Syntax: MOV3Q.L #<data>,<ea>x

Attributes: Size = longword

Description: Move the immediate data to the operand at the destination location. The data range is from -1 to 7, excluding 0. The 3-bit immediate operand is sign extended to a longword operand and all 32 bits are transferred to the destination location.

Condition Codes:

X	N	Z	V	C
—	*	*	0	0

X Not affected
 N Set if result is negative; cleared otherwise
 Z Set if the result is zero; cleared otherwise
 V Always cleared
 C Always cleared

Instruction Format:

15	14	13	12	11	10	9	8	7	6	5	4	3	2	1	0	
1	0	1	0	Immediate Data				1	0	1	Destination Effective Address					
										Mode		Register				

Instruction Fields:

- Immediate data field—3 bits of data having a range {-1,1-7} where a data value of 0 represents -1.
- Destination Effective Address field—Specifies the destination operand, <ea>x; use only data addressing modes listed in the following table:

Addressing Mode	Mode	Register	Addressing Mode	Mode	Register
Dx	000	reg. number:Dx	(xxx).W	111	000
Ax	001	reg. number:Ax	(xxx).L	111	001
(Ax)	010	reg. number:Ax	#<data>	—	—
(Ax) +	011	reg. number:Ax			
– (Ax)	100	reg. number:Ax			
(d ₁₆ ,Ax)	101	reg. number:Ax	(d ₁₆ ,PC)	—	—
(d ₈ ,Ax,Xi)	110	reg. number:Ax	(d ₈ ,PC,Xi)	—	—

MOVE

Move Data from Source to Destination
First appeared in ISA_A

MOVE

Operation: Source → Destination

Assembler Syntax: MOVE.sz <ea>y,<ea>x

Attributes: Size = byte, word, longword

Description: Moves the data at the source to the destination location and sets the condition codes according to the data. The size of the operation may be specified as byte, word, or longword. MOVEA is used when the destination is an address register. MOVEQ is used to move an immediate 8-bit value to a data register. MOV3Q (supported starting with ISA_B) is used to move a 3-bit immediate value to any effective destination address.

Condition Codes:

X	N	Z	V	C
—	*	*	0	0

X Not affected
 N Set if result is negative; cleared otherwise
 Z Set if the result is zero; cleared otherwise
 V Always cleared
 C Always cleared

Instruction Format:

15	14	13	12	11	10	9	8	7	6	5	4	3	2	1	0
0	0	Size			Destination Effective Address				Source Effective Address						
				Register		Mode		Mode		Register					

Instruction fields:

- Size field—Specifies the size of the operand to be moved:
 - 01 byte operation
 - 11 word operation
 - 10 longword operation
- Destination Effective Address field—Specifies destination location, <ea>x; the table below lists possible data alterable addressing modes. The restrictions on combinations of source and destination addressing modes are listed in the table at the bottom of the next page.

Addressing Mode	Mode	Register	Addressing Mode	Mode	Register
Dx	000	reg. number:Dx	(xxx).W	111	000
Ax	—	—	(xxx).L	111	001
(Ax)	010	reg. number:Ax	#<data>	—	—
(Ax) +	011	reg. number:Ax			
– (Ax)	100	reg. number:Ax			
(d ₁₆ ,Ax)	101	reg. number:Ax	(d ₁₆ ,PC)	—	—
(d ₈ ,Ax,Xi)	110	reg. number:Ax	(d ₈ ,PC,Xi)	—	—

MOVE

Move Data from Source to Destination

MOVE

Instruction fields (continued):

- Source Effective Address field—Specifies source operand, <ea>y; the table below lists possible addressing modes. The restrictions on combinations of source and destination addressing modes are listed in the table at the bottom of the next page.

Addressing Mode	Mode	Register	Addressing Mode	Mode	Register
Dy	000	reg. number:Dy	(xxx).W	111	000
Ay	001	reg. number:Ay	(xxx).L	111	001
(Ay)	010	reg. number:Ay	#<data>	111	100
(Ay) +	011	reg. number:Ay			
– (Ay)	100	reg. number:Ay			
(d ₁₆ ,Ay)	101	reg. number:Ay	(d ₁₆ ,PC)	111	010
(d ₈ ,Ay,Xi)	110	reg. number:Ay	(d ₈ ,PC,Xi)	111	011

NOTE

Not all combinations of source/destination addressing modes are possible. The table below shows the possible combinations. Starting with ISA_B, the combination of #<xxx>,d₁₆(Ax) can be used with MOVE.B and MOVE.W opcodes.

Source Addressing Mode	Destination Addressing Mode
Dy, Ay, (Ay), (Ay)+,-(Ay)	All possible
(d ₁₆ , Ay), (d16, PC)	All possible except (d ₈ , Ax, Xi), (xxx).W, (xxx).L
(d ₈ , Ay, Xi), (d ₈ , PC, Xi), (xxx).W, (xxx).L, #<xxx>	All possible except (d ₁₆ , Ax), (d ₈ , Ax, Xi), (xxx).W, (xxx).L

MOVEA

Move Address from Source to Destination

MOVEA

First appeared in ISA_A

Operation: Source → Destination

Assembler Syntax: MOVEA.sz <ea>y,Ax

Attributes: Size = word, longword

Description: Moves the address at the source to the destination address register. The size of the operation may be specified as word or longword. Word size source operands are sign extended to 32-bit quantities before the operation is done.

Condition Codes: Not affected

Instruction Format:	15	14	13	12	11	10	9	8	7	6	5	4	3	2	1	0
	0	0	Size		Destination Register, Ax		0	0	1	Source Effective Address						
													Mode		Register	

Instruction fields:

- Size field—Specifies the size of the operand to be moved:
 - 0x reserved
 - 11 word operation
 - 10 longword operation
- Destination Register field — Specifies the destination address register, Ax.
- Source Effective Address field—Specifies the source operand, <ea>y; the table below lists possible modes.

Addressing Mode	Mode	Register	Addressing Mode	Mode	Register
Dy	000	reg. number:Dy	(xxx).W	111	000
Ay	001	reg. number:Ay	(xxx).L	111	001
(Ay)	010	reg. number:Ay	#<data>	111	100
(Ay) +	011	reg. number:Ay			
– (Ay)	100	reg. number:Ay			
(d ₁₆ ,Ay)	101	reg. number:Ay	(d ₁₆ ,PC)	111	010
(d ₈ ,Ay,Xi)	110	reg. number:Ay	(d ₈ ,PC,Xi)	111	011

MOVEM

Move Multiple Registers First appeared in ISA_A

MOVEM

Operation: Registers → Destination;
Source → Registers

Assembler Syntax: MOVEM.L #list,<ea>x
MOVEM.L <ea>y,#list

Attributes: Size = longword

Description: Moves the contents of selected registers to or from consecutive memory locations starting at the location specified by the effective address. A register is selected if the bit in the mask field corresponding to that register is set.

The registers are transferred starting at the specified address, and the address is incremented by the operand length (4) following each transfer. The order of the registers is from D0 to D7, then from A0 to A7.

Condition Codes: Not affected

Instruction Format:	15	14	13	12	11	10	9	8	7	6	5	4	3	2	1	0
	0	1	0	0	1	dr	0	0	1	1	Effective Address					
											Mode		Register			
	Register List Mask															

Instruction Fields:

- dr field—Specifies the direction of the transfer:
 - 0 register to memory
 - 1 memory to register
- Effective Address field—Specifies the memory address for the data transfer. For register-to-memory transfers, use the following table for <ea>x.

Addressing Mode	Mode	Register	Addressing Mode	Mode	Register
Dx	—	—	(xxx).W	—	—
Ax	—	—	(xxx).L	—	—
(Ax)	010	reg. number:Ax	#<data>	—	—
(Ax) +	—	—			
– (Ax)	—	—			
(d ₁₆ ,Ax)	101	reg. number:Ax	(d ₁₆ ,PC)	—	—
(d ₈ ,Ax,Xi)	—	—	(d ₈ ,PC,Xi)	—	—

MOVEM

Move Multiple Registers

MOVEM

Instruction Fields (continued):

- Effective Address field (continued)—For memory-to-register transfers, use the following table for <ea>y.

Addressing Mode	Mode	Register	Addressing Mode	Mode	Register
Dy	—	—	(xxx).W	—	—
Ay	—	—	(xxx).L	—	—
(Ay)	010	reg. number: Ay	#<data>	—	—
(Ay) +	—	—			
– (Ay)	—	—			
(d ₁₆ , Ay)	101	reg. number: Ay	(d ₁₆ , PC)	—	—
(d ₈ , Ay, Xi)	—	—	(d ₈ , PC, Xi)	—	—

- Register List Mask field—Specifies the registers to be transferred. The low-order bit corresponds to the first register to be transferred; the high-order bit corresponds to the last register to be transferred. The mask correspondence is shown below.

15	14	13	12	11	10	9	8	7	6	5	4	3	2	1	0
A7	A6	A5	A4	A3	A2	A1	A0	D7	D6	D5	D4	D3	D2	D1	D0

MOVEQ

Move Quick
First appeared in ISA_A

MOVEQ

Operation: Immediate Data → Destination

Assembler Syntax: MOVEQ.L #<data>,Dx

Attributes: Size = longword

Description: Moves a byte of immediate data to a 32-bit data register, Dx. The data in an 8-bit field within the operation word is sign-extended to a longword operand in the data register as it is transferred.

Condition Codes:	X	N	Z	V	C	X Not affected
	—	*	*	0	0	N Set if result is negative; cleared otherwise
						Z Set if the result is zero; cleared otherwise
						V Always cleared
						C Always cleared

Instruction Format:	15	14	13	12	11	10	9	8	7	6	5	4	3	2	1	0
	0	1	1	1	Register, Dx			0	Immediate Data							

Instruction Fields:

- Register field—Specifies the data register, Dx, to be loaded.
- Data field—8 bits of data, which are sign-extended to a longword operand.

MOVE from CCR

Move from the
Condition Code Register
First appeared in ISA_A

MOVE from CCR

Operation: CCR → Destination

Assembler Syntax: MOVE.W CCR,Dx

Attributes: Size = Word

Description: Moves the condition code bits (zero-extended to word size) to the destination location, Dx. The operand size is a word. Unimplemented bits are read as zeros.

Condition Codes: Not affected

Instruction	15	14	13	12	11	10	9	8	7	6	5	4	3	2	1	0
Format:	0	1	0	0	0	0	1	0	1	1	0	0	0	Register, Dx		

Instruction Field:

- Register field - Specifies destination data register, Dx.

MOVE to CCR

MOVE to CCR

Move to the Condition Code Register

First appeared in ISA_A

Operation: Source → CCR

Assembler Syntax: MOVE.B Dy,CCR
MOVE.B #<data>,CCR

Attributes: Size = Byte

Description: Moves the low-order byte of the source operand to the condition code register. The upper byte of the source operand is ignored; the upper byte of the status register is not altered.

Condition Codes:

X	N	Z	V	C
*	*	*	*	*

X Set to the value of bit 4 of the source operand
 N Set to the value of bit 3 of the source operand
 Z Set to the value of bit 2 of the source operand
 V Set to the value of bit 1 of the source operand
 C Set to the value of bit 0 of the source operand

Instruction Format:

	15	14	13	12	11	10	9	8	7	6	5	4	3	2	1	0
	0	1	0	0	0	1	0	0	1	1	Source Effective Address					
											Mode		Register			

Instruction Field:

- Effective Address field—Specifies the location of the source operand; use only those data addressing modes listed in the following table:

Addressing Mode	Mode	Register	Addressing Mode	Mode	Register
Dy	000	reg. number:Dy	(xxx).W	—	—
Ay	—	—	(xxx).L	—	—
(Ay)	—	—	#<data>	111	100
(Ay) +	—	—			
– (Ay)	—	—			
(d ₁₆ ,Ay)	—	—	(d ₁₆ ,PC)	—	—
(d ₈ ,Ay,Xi)	—	—	(d ₈ ,PC,Xi)	—	—

MULS

Signed Multiply First appeared in ISA_A

MULS

Operation: Source * Destination → Destination

Assembler Syntax: MULS.W <ea>y,Dx 16 x 16 → 32
MULS.L <ea>y,Dx 32 x 32 → 32

Attributes: Size = word, longword

Description: Multiplies two signed operands yielding a signed result. This instruction has a word operand form and a longword operand form.

In the word form, the multiplier and multiplicand are both word operands, and the result is a longword operand. A register operand is the low-order word; the upper word of the register is ignored. All 32 bits of the product are saved in the destination data register.

In the longword form, the multiplier and multiplicand are both longword operands. The destination data register stores the low order 32-bits of the product. The upper 32 bits of the product are discarded.

Note that CCR[V] is always cleared by MULS, unlike the 68K family processors.

Condition Codes:	X	N	Z	V	C	X Not affected
	—	*	*	0	0	N Set if result is negative; cleared otherwise
						Z Set if the result is zero; cleared otherwise
						V Always cleared
						C Always cleared

Instruction Format (Word)	15	14	13	12	11	10	9	8	7	6	5	4	3	2	1	0
	1	1	0	0	Register, Dx				1	1	1	Source Effective Address				
												Mode			Register	

Instruction Fields (Word):

- Register field—Specifies the destination data register, Dx.
- Effective Address field—Specifies the source operand, <ea>y; use only those data addressing modes listed in the following table:

Addressing Mode	Mode	Register	Addressing Mode	Mode	Register
Dy	000	reg. number:Dy	(xxx).W	111	000
Ay	—	—	(xxx).L	111	001
(Ay)	010	reg. number: Ay	#<data>	111	100
(Ay) +	011	reg. number: Ay			
– (Ay)	100	reg. number: Ay			
(d ₁₆ ,Ay)	101	reg. number: Ay	(d ₁₆ ,PC)	111	010
(d ₈ ,Ay,Xi)	110	reg. number: Ay	(d ₈ ,PC,Xi)	111	011

MULS

Signed Multiply

MULS

**Instruction
Format:
(Longword)**

15	14	13	12	11	10	9	8	7	6	5	4	3	2	1	0
0	1	0	0	1	1	0	0	0	0	Source Effective Address					
								Mode			Register				
0	Register, Dx			1	0	0	0	0	0	0	0	0	0	0	0

Instruction Fields (Longword):

- Source Effective Address field—Specifies the source operand; use only data addressing modes listed in the following table:

Addressing Mode	Mode	Register	Addressing Mode	Mode	Register
Dy	000	reg. number:Dy	(xxx).W	—	—
Ay	—	—	(xxx).L	—	—
(Ay)	010	reg. number: Ay	#<data>	—	—
(Ay) +	011	reg. number: Ay			
– (Ay)	100	reg. number: Ay			
(d ₁₆ , Ay)	101	reg. number: Ay	(d ₁₆ , PC)	—	—
(d ₈ , Ay, Xi)	—	—	(d ₈ , PC, Xi)	—	—

- Register field—Specifies a data register, Dx, for the destination operand; the 32-bit multiplicand comes from this register, and the low-order 32 bits of the product are loaded into this register.

MULU

Unsigned Multiply First appeared in ISA_A

MULU

Operation: Source * Destination → Destination

Assembler Syntax: MULU.W <ea>y,Dx 16 x 16 → 32
MULU.L <ea>y,Dx 32 x 32 → 32

Attributes: Size = word, longword

Description: Multiplies two unsigned operands yielding an unsigned result. This instruction has a word operand form and a longword operand form.

In the word form, the multiplier and multiplicand are both word operands, and the result is a longword operand. A register operand is the low-order word; the upper word of the register is ignored. All 32 bits of the product are saved in the destination data register.

In the longword form, the multiplier and multiplicand are both longword operands, and the destination data register stores the low order 32 bits of the product. The upper 32 bits of the product are discarded.

Note that CCR[V] is always cleared by MULU, unlike the 68K family processors.

Condition Codes:	X	N	Z	V	C	X Not affected
	—	*	*	0	0	N Set if result is negative; cleared otherwise
						Z Set if the result is zero; cleared otherwise
						V Always cleared
						C Always cleared

Instruction Format (Word)	15	14	13	12	11	10	9	8	7	6	5	4	3	2	1	0
	1	1	0	0	Register, Dx				0	1	1	Source Effective Address				
												Mode		Register		

Instruction Fields (Word):

- Register field—Specifies the destination data register, Dx.
- Effective Address field—Specifies the source operand, <ea>y; use only those data addressing modes listed in the following table:

Addressing Mode	Mode	Register	Addressing Mode	Mode	Register
Dy	000	reg. number:Dy	(xxx).W	111	000
Ay	—	—	(xxx).L	111	001
(Ay)	010	reg. number: Ay	#<data>	111	100
(Ay) +	011	reg. number: Ay			
– (Ay)	100	reg. number: Ay			
(d ₁₆ ,Ay)	101	reg. number: Ay	(d ₁₆ ,PC)	111	010
(d ₈ ,Ay,Xi)	110	reg. number: Ay	(d ₈ ,PC,Xi)	111	011

MULU

Unsigned Multiply

MULU

**Instruction
Format:
(Longword)**

15	14	13	12	11	10	9	8	7	6	5	4	3	2	1	0
0	1	0	0	1	1	0	0	0	0	Source Effective Address					
								Mode			Register				
0	Register, Dx			0	0	0	0	0	0	0	0	0	0	0	0

Instruction Fields (Longword):

- Source Effective Address field—Specifies the source operand; use only data addressing modes listed in the following table:

Addressing Mode	Mode	Register	Addressing Mode	Mode	Register
Dy	000	reg. number:Dy	(xxx).W	—	—
Ay	—	—	(xxx).L	—	—
(Ay)	010	reg. number: Ay	#<data>	—	—
(Ay) +	011	reg. number: Ay			
– (Ay)	100	reg. number: Ay			
(d ₁₆ , Ay)	101	reg. number: Ay	(d ₁₆ , PC)	—	—
(d ₈ , Ay, Xi)	—	—	(d ₈ , PC, Xi)	—	—

- Register field—Specifies a data register, Dx, for the destination operand; the 32-bit multiplicand comes from this register, and the low-order 32 bits of the product are loaded into this register.

MVS

Move with Sign Extend First appeared in ISA_B

MVS

Operation: Source with sign extension → Destination

Assembler Syntax: MVS.sz <ea>y,Dx

Attributes: Size = byte, word

Description: Sign-extend the source operand and move to the destination register. For the byte operation, bit 7 of the source is copied to bits 31–8 of the destination. For the word operation, bit 15 of the source is copied to bits 31-16 of the destination.

Condition Codes:

X	N	Z	V	C
—	*	*	0	0

X Not affected
 N Set if result is negative; cleared otherwise
 Z Set if the result is zero; cleared otherwise
 V Always cleared
 C Always cleared

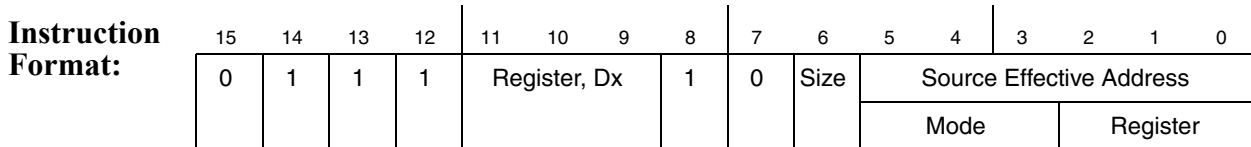

Instruction Fields:

- Register field—Specifies the destination data register, Dx.
- Size field—Specifies the size of the operation
 - 0 byte operation
 - 1 word operation
- Source Effective Address field—specifies the source operand, <ea>y; use only data addressing modes from the following table:

Addressing Mode	Mode	Register	Addressing Mode	Mode	Register
Dy	000	reg. number:Dy	(xxx).W	111	000
Ay	001	reg. number:Ay	(xxx).L	111	001
(Ay)	010	reg. number:Ay	#<data>	111	100
(Ay) +	011	reg. number:Ay			
– (Ay)	100	reg. number:Ay			
(d ₁₆ ,Ay)	101	reg. number:Ay	(d ₁₆ ,PC)	111	010
(d ₈ ,Ay,Xi)	110	reg. number:Ay	(d ₈ ,PC,Xi)	111	011

MVZ

Move with Zero-Fill
First appeared in ISA_B

MVZ

Operation: Source with zero fill → Destination

Assembler Syntax: MVZ.sz <ea>y,Dx

Attributes: Size = byte, word

Description: Zero-fill the source operand and move to the destination register. For the byte operation, the source operand is moved to bits 7–0 of the destination and bits 31–8 are filled with zeros. For the word operation, the source operand is moved to bits 15–0 of the destination and bits 31–16 are filled with zeros.

Condition Codes:	X	N	Z	V	C	X Not affected
	—	0	*	0	0	N Always cleared
						Z Set if the result is zero; cleared otherwise
						V Always cleared
						C Always cleared

Instruction Format:	15	14	13	12	11	10	9	8	7	6	5	4	3	2	1	0
	0	1	1	1	Register, Dx				1	1	Size	Source Effective Address				
												Mode		Register		

Instruction Fields:

- Register field—Specifies the destination data register, Dx.
- Size field—Specifies the size of the operation
 - 0 byte operation
 - 1 word operation
- Source Effective Address field—Specifies the source operand, <ea>y; use the following data addressing modes:

Addressing Mode	Mode	Register	Addressing Mode	Mode	Register
Dy	000	reg. number:Dy	(xxx).W	111	000
Ay	001	reg. number:Ay	(xxx).L	111	001
(Ay)	010	reg. number:Ay	#<data>	111	100
(Ay) +	011	reg. number:Ay			
– (Ay)	100	reg. number:Ay			
(d ₁₆ ,Ay)	101	reg. number:Ay	(d ₁₆ ,PC)	111	010
(d ₈ ,Ay,Xi)	110	reg. number:Ay	(d ₈ ,PC,Xi)	111	011

NEG

Negate

NEG

First appeared in ISA_A

Operation: 0 – Destination → Destination

Assembler Syntax: NEGL Dx

Attributes: Size = longword

Description: Subtracts the destination operand from zero and stores the result in the destination location.
The size of the operation is specified as a longword.

Condition Codes:	X	N	Z	V	C	X	Set the same as the carry bit
	*	*	*	*	*	N	Set if the result is negative; cleared otherwise
						Z	Set if the result is zero; cleared otherwise
						V	Set if an overflow is generated; cleared otherwise
						C	Cleared if the result is zero; set otherwise

Instruction Format:	15	14	13	12	11	10	9	8	7	6	5	4	3	2	1	0
	0	1	0	0	0	1	0	0	1	0	0	0	0	Register, Dx		

Instruction Fields:

- Register field - Specifies data register, Dx.

NEGX

Negate with Extend

First appeared in ISA_A

NEGX

Operation: $0 - \text{Destination} - \text{CCR}[X] \rightarrow \text{Destination}$

Assembler Syntax: NEGX.L Dx

Attributes: Size = longword

Description: Subtracts the destination operand and CCR[X] from zero. Stores the result in the destination location. The size of the operation is specified as a longword.

Condition Codes:	X	N	Z	V	C	X Set the same as the carry bit
	*	*	*	*	*	N Set if the result is negative; cleared otherwise
						Z Cleared if the result is nonzero; unchanged otherwise
						V Set if an overflow is generated; cleared otherwise
						C Set if a borrow occurs; cleared otherwise

Normally CCR[Z] is set explicitly via programming before the start of an NEGX operation to allow successful testing for zero results upon completion of multiple-precision operations.

Instruction Format:	15	14	13	12	11	10	9	8	7	6	5	4	3	2	1	0
	0	1	0	0	0	0	0	0	1	0	0	0	0	Register, Dx		

Instruction Fields:

- Register field - Specifies data register, Dx.

NOP

No Operation
First appeared in ISA_A

NOP

Operation: None

Assembler Syntax: NOP

Attributes: Unsized

Description: Performs no operation. The processor state, other than the program counter, is unaffected. Execution continues with the instruction following the NOP instruction. The NOP instruction does not begin execution until all pending bus cycles have completed, synchronizing the pipeline and preventing instruction overlap.

Because the NOP instruction is specified to perform a pipeline synchronization in addition to performing no operation, the execution time is multiple cycles. In cases where only code alignment is desired, it is preferable to use the TPF instruction, which operates as a 1-cycle no operation instruction. The opcode for NOP is 0x4E71.

Condition Codes: Not affected

Instruction Format:

15	14	13	12	11	10	9	8	7	6	5	4	3	2	1	0
0	1	0	0	1	1	1	0	0	1	1	1	0	0	0	1

NOT

Logical Complement First appeared in ISA_A

NOT

Operation: ~ Destination → Destination

Assembler Syntax: NOT.L Dx

Attributes: Size = longword

Description: Calculates the ones complement of the destination operand and stores the result in the destination location. The size of the operation is specified as a longword.

Condition Codes:	X	N	Z	V	C	X Not affected
	—	*	*	0	0	N Set if result is negative; cleared otherwise
						Z Set if the result is zero; cleared otherwise
						V Always cleared
						C Always cleared

Instruction Format:	15	14	13	12	11	10	9	8	7	6	5	4	3	2	1	0
	0	1	0	0	0	1	1	0	1	0	0	0	0	Register, Dx		

Instruction Fields:

- Register field — Specifies data register, Dx.

OR

Inclusive-OR Logical First appeared in ISA_A

OR

Operation: Source | Destination → Destination

Assembler Syntax: OR.L <ea>y,Dx
OR.L Dy,<ea>x

Attributes: Size = longword

Description: Performs an inclusive-OR operation on the source operand and the destination operand and stores the result in the destination location. The size of the operation is specified as a longword. The contents of an address register may not be used as an operand.

The Dx mode is used when the destination is a data register; the destination <ea> mode is invalid for a data register.

In addition, ORI is used when the source is immediate data.

Condition Codes:	X	N	Z	V	C	X Not affected
	—	*	*	0	0	N Set if the msb of the result is set; cleared otherwise
						Z Set if the result is zero; cleared otherwise
						V Always cleared
						C Always cleared

Instruction Format:	15	14	13	12	11	10	9	8	7	6	5	4	3	2	1	0
	1	0	0	0	Register				Opmode		Effective Address					
													Mode		Register	

Instruction Fields:

- Register field—Specifies the data register.
- Opmode field:

Byte	Word	Longword	Operation
—	—	010	<ea>y Dx → Dx
—	—	110	Dy <ea>x → <ea>x

Instruction Fields (continued):

- Effective Address field—Determines addressing mode
 - For the source operand <ea>y, use addressing modes listed in the following table:

Addressing Mode	Mode	Register	Addressing Mode	Mode	Register
Dy	000	reg. number:Dy	(xxx).W	111	000
Ay	—	—	(xxx).L	111	001
(Ay)	010	reg. number:Ay	#<data>	111	100
(Ay) +	011	reg. number:Ay			
– (Ay)	100	reg. number:Ay			
(d ₁₆ ,Ay)	101	reg. number:Ay	(d ₁₆ ,PC)	111	010
(d ₈ ,Ay,Xi)	110	reg. number:Ay	(d ₈ ,PC,Xi)	111	011

- For the destination operand <ea>x, use addressing modes listed in the following table:

Addressing Mode	Mode	Register	Addressing Mode	Mode	Register
Dx	—	—	(xxx).W	111	000
Ax	—	—	(xxx).L	111	001
(Ax)	010	reg. number:Ax	#<data>	—	—
(Ax) +	011	reg. number:Ax			
– (Ax)	100	reg. number:Ax			
(d ₁₆ ,Ax)	101	reg. number:Ax	(d ₁₆ ,PC)	—	—
(d ₈ ,Ax,Xi)	110	reg. number:Ax	(d ₈ ,PC,Xi)	—	—

ORI

Inclusive-OR First appeared in ISA_A

ORI

Operation: Immediate Data | Destination → Destination

Assembler Syntax: ORI.L #<data>,Dx

Attributes: Size = longword

Description: Performs an inclusive-OR operation on the immediate data and the destination operand and stores the result in the destination data register, Dx. The size of the operation is specified as a longword. The size of the immediate data is specified as a longword. Note that the immediate data is contained in the two extension words, with the first extension word, bits [15:0], containing the upper word, and the second extension word, bits [15:0], containing the lower word.

Condition Codes:	X	N	Z	V	C	X	Not affected
	—	*	*	0	0	N	Set if the msb of the result is set; cleared otherwise
						Z	Set if the result is zero; cleared otherwise
						V	Always cleared
						C	Always cleared

Instruction Format:	15	14	13	12	11	10	9	8	7	6	5	4	3	2	1	0
	0	0	0	0	0	0	0	0	1	0	0	0	0	Register, Dx		
	Upper Word of Immediate Data															
	Lower Word of Immediate Data															

Instruction Fields:

- Destination register field - Specifies the destination data register, Dx.

PEA

Push Effective Address

First appeared in ISA_A

PEA

Operation: $SP - 4 \rightarrow SP; \langle ea \rangle y \rightarrow (SP)$

Assembler Syntax: PEA.L $\langle ea \rangle y$

Attributes: Size = longword

Description: Computes the effective address and pushes it onto the stack. The effective address is a longword address.

Condition Codes: Not affected

Instruction Format:	15	14	13	12	11	10	9	8	7	6	5	4	3	2	1	0
	0	1	0	0	1	0	0	0	0	1	Source Effective Address					
											Mode			Register		

Instruction Field:

- Effective Address field—Specifies the address, $\langle ea \rangle y$, to be pushed onto the stack; use only those control addressing modes listed in the following table:

Addressing Mode	Mode	Register	Addressing Mode	Mode	Register
Dy	—	—	(xxx).W	111	000
Ay	—	—	(xxx).L	111	001
(Ay)	010	reg. number: Ay	#<data>	—	—
(Ay) +	—	—			
– (Ay)	—	—			
(d ₁₆ , Ay)	101	reg. number: Ay	(d ₁₆ , PC)	111	010
(d ₈ , Ay, Xi)	110	reg. number: Ay	(d ₈ , PC, Xi)	111	011

PULSE

Generate Unique Processor Status

PULSE

First appeared in ISA_A

Operation: Set PST = 0x4

Assembler Syntax: PULSE

Attributes: Unsized

Description: Performs no operation. The processor state, other than the program counter, is unaffected. However, PULSE generates a special encoding of the Processor Status (PST) output pins, making it very useful for external triggering purposes. The opcode for PULSE is 0x4ACC.

Condition Codes: Not affected

Instruction Format:

15	14	13	12	11	10	9	8	7	6	5	4	3	2	1	0
0	1	0	0	1	0	1	0	1	1	0	0	1	1	0	0

REMS

Signed Divide Remainder

REMS

First appeared in ISA_A

Not implemented in MCF5202, MCF5204 and MCR5206

Operation: Destination/Source → Remainder

Assembler Syntax: REMS.L <ea>y,Dw:Dx 32-bit Dx/32-bit <ea>y Æ 32r in Dw
where r indicates the remainder

Attributes: Size = longword

Description: Divide the signed destination operand by the signed source and store the signed remainder in another register. If Dw is specified to be the same register as Dx, the DIVS instruction is executed rather than REMS. To determine the quotient, use DIVS.

An attempt to divide by zero results in a divide-by-zero exception and no registers are affected. The resulting exception stack frame points to the offending REMS opcode. If overflow is detected, the destination register is unaffected. An overflow occurs if the quotient is larger than a 32-bit signed integer.

Condition Codes:

X	N	Z	V	C
—	*	*	*	0

X Not affected
 N Cleared if overflow is detected; otherwise set if the quotient is negative, cleared if positive
 Z Cleared if overflow is detected; otherwise set if the quotient is zero, cleared if nonzero
 V Set if an overflow occurs; cleared otherwise
 C Always cleared

Instruction Format:

15	14	13	12	11	10	9	8	7	6	5	4	3	2	1	0
0	1	0	0	1	1	0	0	0	1	Source Effective Address					
										Mode		Register			
0	Register Dx			1	0	0	0	0	0	0	0	0	Register Dw		

Instruction Fields:

- Register Dx field—Specifies the destination register, Dx.
- Source Effective Address field— Specifies the source operand, <ea>y; use addressing modes in the following table:

Addressing Mode	Mode	Register	Addressing Mode	Mode	Register
Dy	000	reg. number:Dy	(xxx).W	—	—
Ay	—	—	(xxx).L	—	—
(Ay)	010	reg. number: Ay	#<data>	—	—
(Ay) +	011	reg. number: Ay			
– (Ay)	100	reg. number: Ay			
(d ₁₆ ,Ay)	101	reg. number: Ay	(d ₁₆ ,PC)	—	—
(d ₈ ,Ay,Xi)	—	—	(d ₈ ,PC,Xi)	—	—

- Register Dw field—Specifies the remainder register, Dw.

REMU

Unsigned Divide Remainder

REMU

First appeared in ISA_A

Not implemented in MCF5202, MCF5204 and MCF5206

Operation: Destination/Source → Remainder

Assembler Syntax: REMU.L <ea>y,Dw:Dx 32-bit Dx/32-bit <ea>y Æ 32r in Dw
where r indicates the remainder

Attributes: Size = longword

Description: Divide the unsigned destination operand by the unsigned source and store the unsigned remainder in another register. If Dw is specified to be the same register as Dx, the DIVU instruction is executed rather than REMU. To determine the quotient, use DIVU.

An attempt to divide by zero results in a divide-by-zero exception and no registers are affected. The resulting exception stack frame points to the offending REMU opcode. If overflow is detected, the destination register is unaffected. An overflow occurs if the quotient is larger than a 32-bit signed integer.

Condition Codes:

X	N	Z	V	C
—	*	*	*	0

X Not affected
 N Cleared if overflow is detected; otherwise set if the quotient is negative, cleared if positive
 Z Cleared if overflow is detected; otherwise set if the quotient is zero, cleared if nonzero
 V Set if an overflow occurs; cleared otherwise
 C Always cleared

Instruction Format:

15	14	13	12	11	10	9	8	7	6	5	4	3	2	1	0
0	1	0	0	1	1	0	0	0	1	Source Effective Address					
										Mode		Register			
0	Register Dx			0	0	0	0	0	0	0	0	0	Register Dw		

Instruction Fields:

- Register Dx field—Specifies the destination register, Dx.
- Source Effective Address field— Specifies the source operand, <ea>y; use addressing modes in the following table:

Addressing Mode	Mode	Register	Addressing Mode	Mode	Register
Dy	000	reg. number:Dy	(xxx).W	—	—
Ay	—	—	(xxx).L	—	—
(Ay)	010	reg. number: Ay	#<data>	—	—
(Ay) +	011	reg. number: Ay			
– (Ay)	100	reg. number: Ay			
(d ₁₆ ,Ay)	101	reg. number: Ay	(d ₁₆ ,PC)	—	—
(d ₈ ,Ay,Xi)	—	—	(d ₈ ,PC,Xi)	—	—

- Register Dw field—Specifies the remainder register, Dw.

RTS

Return from Subroutine

First appeared in ISA_A

RTS

Operation: (SP) → PC; SP + 4 → SP

Assembler Syntax: RTS

Attributes: Unsized

Description: Pulls the program counter value from the stack. The previous program counter value is lost. The opcode for RTS is 0x4E75.

Condition Codes: Not affected

Instruction	15	14	13	12	11	10	9	8	7	6	5	4	3	2	1	0
Format:	0	1	0	0	1	1	1	0	0	1	1	1	0	1	0	1

SATS

Signed Saturate
First appeared in ISA_B

SATS

Operation:

```

If CCR[V] == 1,
    then if Dx[31] == 0,
        then Dx[31:0] = 0x80000000
        else Dx[31:0] = 0x7FFFFFFF
    else Dx[31:0] is unchanged

```

Assembler Syntax: SATS.L Dx

Attributes: Size = longword

Description: Update the destination register only if the overflow bit of the CCR is set. If the operand is negative, then set the result to greatest positive number; otherwise, set the result to the largest negative value. The condition codes are set according to the result.

Condition Codes:

X	N	Z	V	C
—	*	*	0	0

- X Not affected
- N Set if the result is negative; cleared otherwise
- Z Set if the result is zero; cleared otherwise
- V Always cleared
- C Always cleared

Instruction Format:

15	14	13	12	11	10	9	8	7	6	5	4	3	2	1	0
0	1	0	0	1	1	0	0	1	0	0	0	0	Register, Dx		

Instruction Fields:

- Register field—Specifies the destination data register, Dx.

Scc

Set According to Condition

First appeared in ISA_A

Scc

Operation: If Condition True
 Then 1s → Destination
 Else 0s → Destination

Assembler Syntax: Scc.B Dx

Attributes: Size = byte

Description: Tests the specified condition code; if the condition is true, sets the lowest byte of the destination data register to TRUE (all ones). Otherwise, sets that byte to FALSE (all zeros). Condition code cc specifies one of the following conditional tests, where C, N, V, and Z represent CCR[C], CCR[N], CCR[V], and CCR[Z], respectively:

Code	Condition	Encod- ing	Test	Code	Condition	Encod- ing	Test
CC(HS)	Carry clear	0100	\overline{C}	LS	Lower or same	0011	$C Z$
CS(LO)	Carry set	0101	C	LT	Less than	1101	$N \& \overline{V} \overline{N} \& V$
EQ	Equal	0111	Z	MI	Minus	1011	N
F	False	0001	0	NE	Not equal	0110	\overline{Z}
GE	Greater or equal	1100	$N \& V \overline{N} \& \overline{V}$	PL	Plus	1010	\overline{N}
GT	Greater than	1110	$N \& V \& \overline{Z} \overline{N} \& \overline{V} \& \overline{Z}$	T	True	0000	1
HI	High	0010	$\overline{C} \& \overline{Z}$	VC	Overflow clear	1000	\overline{V}
LE	Less or equal	1111	$Z N \& \overline{V} \overline{N} \& V$	VS	Overflow set	1001	V

Condition Codes: Not affected

Instruction	15	14	13	12	11	10	9	8	7	6	5	4	3	2	1	0
Format:	0	1	0	1	Condition				1	1	0	0	0	Register, Dx		

Instruction Fields:

- Condition field—Binary code for one of the conditions listed in the table.
- Register field—Specifies the destination data register, Dx.

SUB

Subtract

SUB

First appeared in ISA_A

Operation: Destination – Source → Destination

Assembler Syntax: SUB.L <ea>y,Dx
SUB.L Dy,<ea>x

Attributes: Size = longword

Description: Subtracts the source operand from the destination operand and stores the result in the destination. The size of the operation is specified as a longword. The mode of the instruction indicates which operand is the source and which is the destination.

The Dx mode is used when the destination is a data register; the destination <ea> mode is invalid for a data register.

In addition, SUBA is used when the destination is an address register. SUBI and SUBQ are used when the source is immediate data.

Condition Codes:	X	N	Z	V	C	
	*	*	*	*	*	

X Set the same as the carry bit
N Set if the result is negative; cleared otherwise
Z Set if the result is zero; cleared otherwise
V Set if an overflow is generated; cleared otherwise
C Set if an carry is generated; cleared otherwise

Instruction Format:	15	14	13	12	11	10	9	8	7	6	5	4	3	2	1	0
	1	0	0	1	Register				Opmode			Effective Address				
													Mode		Register	

Instruction Fields:

- Register field—Specifies the data register.
- Opmode field:

Byte	Word	Longword	Operation
—	—	010	Dx - <ea>y → Dx
—	—	110	<ea>x - Dy → <ea>x

SUB

Subtract

SUB

Instruction Fields (continued):

- Effective Address field—Determines addressing mode
 - For the source operand <ea>y, use addressing modes listed in the following table:

Addressing Mode	Mode	Register	Addressing Mode	Mode	Register
Dy	000	reg. number:Dy	(xxx).W	111	000
Ay	001	reg. number:Ay	(xxx).L	111	001
(Ay)	010	reg. number:Ay	#<data>	111	100
(Ay) +	011	reg. number:Ay			
– (Ay)	100	reg. number:Ay			
(d ₁₆ ,Ay)	101	reg. number:Ay	(d ₁₆ ,PC)	111	010
(d ₈ ,Ay,Xi)	110	reg. number:Ay	(d ₈ ,PC,Xi)	111	011

- For the destination operand <ea>x, use addressing modes listed in the following table:

Addressing Mode	Mode	Register	Addressing Mode	Mode	Register
Dx	—	—	(xxx).W	111	000
Ax	—	—	(xxx).L	111	001
(Ax)	010	reg. number:Ax	#<data>	—	—
(Ax) +	011	reg. number:Ax			
– (Ax)	100	reg. number:Ax			
(d ₁₆ ,Ax)	101	reg. number:Ax	(d ₁₆ ,PC)	—	—
(d ₈ ,Ax,Xi)	110	reg. number:Ax	(d ₈ ,PC,Xi)	—	—

SUBA

Subtract Address First appeared in ISA_A

SUBA

Operation: Destination - Source → Destination

Assembler Syntax: SUBA.L <ea>y,Ax

Attributes: Size = longword

Description: Operates similarly to SUB, but is used when the destination is an address register rather than a data register. Subtracts the source operand from the destination address register and stores the result in the address register. The size of the operation is specified as a longword.

Condition Codes: Not affected

Instruction Format:	15	14	13	12	11	10	9	8	7	6	5	4	3	2	1	0
	1	0	0	1	Destination Register Ax				1	1	1	Source Effective Address				
												Mode		Register		

Instruction Fields:

- Destination Register field—Specifies the destination address register, Ax.
- Source Effective Address field— Specifies the source operand, <ea>y; use addressing modes listed in the following table:

Addressing Mode	Mode	Register	Addressing Mode	Mode	Register
Dy	000	reg. number:Dy	(xxx).W	111	000
Ay	001	reg. number:Ay	(xxx).L	111	001
(Ay)	010	reg. number:Ay	#<data>	111	100
(Ay) +	011	reg. number:Ay			
– (Ay)	100	reg. number:Ay			
(d ₁₆ ,Ay)	101	reg. number:Ay	(d ₁₆ ,PC)	111	010
(d ₈ ,Ay,Xi)	110	reg. number:Ay	(d ₈ ,PC,Xi)	111	011

SUBI

Subtract Immediate

SUBI

First appeared in ISA_A

Operation: Destination - Immediate Data → Destination

Assembler Syntax: SUBI.L #<data>,Dx

Attributes: Size = longword

Description: Operates similarly to SUB, but is used when the source operand is immediate data. Subtracts the immediate data from the destination operand and stores the result in the destination data register, Dx. The size of the operation is specified as longword. Note that the immediate data is contained in the two extension words, with the first extension word, bits [15:0], containing the upper word, and the second extension word, bits [15:0], containing the lower word.

Condition Codes:	X	N	Z	V	C	X	Set the same as the carry bit
	*	*	*	*	*	N	Set if the result is negative; cleared otherwise
						Z	Set if the result is zero; cleared otherwise
						V	Set if an overflow is generated; cleared otherwise
						C	Set if an carry is generated; cleared otherwise

Instruction Format:	15	14	13	12	11	10	9	8	7	6	5	4	3	2	1	0
	0	0	0	0	0	1	0	0	1	0	0	0	0	Register, Dx		
	Upper Word of Immediate Data															
	Lower Word of Immediate Data															

Instruction Fields:

- Destination Register field—Specifies the destination data register, Dx.

SUBQ

Subtract Quick

SUBQ

First appeared in ISA_A

Operation: Destination - Immediate Data → Destination

Assembler Syntax: SUBQ.L #<data>,<ea>x

Attributes: Size = longword

Description: Operates similarly to SUB, but is used when the source operand is immediate data ranging in value from 1 to 8. Subtracts the immediate value from the operand at the destination location. The size of the operation is specified as longword. The immediate data is zero-filled to a longword before being subtracted from the destination. When adding to address registers, the condition codes are not altered.

Condition Codes:

X	N	Z	V	C
*	*	*	*	*

X Set the same as the carry bit
 N Set if the result is negative; cleared otherwise
 Z Set if the result is zero; cleared otherwise
 V Set if an overflow is generated; cleared otherwise
 C Set if an carry is generated; cleared otherwise

Instruction Format:

15	14	13	12	11	10	9	8	7	6	5	4	3	2	1	0
0	1	0	1	Data				1	1	0	Destination Effective Address				
										Mode			Register		

Instruction Fields:

- Data field—3 bits of immediate data representing 8 values (0 – 7), with the immediate values 1-7 representing values of 1-7 respectively and 0 representing a value of 8.
- Destination Effective Address field—specifies the destination location; use only those alterable addressing modes listed in the following table:

Addressing Mode	Mode	Register	Addressing Mode	Mode	Register
Dx	000	reg. number:Dx	(xxx).W	111	000
Ax	001	reg. number:Ax	(xxx).L	111	001
(Ax)	010	reg. number:Ax	#<data>	—	—
(Ax) +	011	reg. number:Ax			
– (Ax)	100	reg. number:Ax			
(d ₁₆ ,Ax)	101	reg. number:Ax	(d ₁₆ ,PC)	—	—
(d ₈ ,Ax,Xi)	110	reg. number:Ax	(d ₈ ,PC,Xi)	—	—

SUBX

Subtract Extended

First appeared in ISA_A

SUBX

Operation: Destination - Source - CCR[X] → Destination

Assembler Syntax: SUBX.L Dy,Dx

Attributes: Size = longword

Description: Subtracts the source operand and CCR[X] from the destination operand and stores the result in the destination location. The size of the operation is specified as a longword.

Condition Codes:	X	N	Z	V	C	X Set the same as the carry bit
	*	*	*	*	*	N Set if the result is negative; cleared otherwise
						Z Cleared if the result is non-zero; unchanged otherwise
						V Set if an overflow is generated; cleared otherwise
						C Set if an carry is generated; cleared otherwise

Normally CCR[Z] is set explicitly via programming before the start of an SUBX operation to allow successful testing for zero results upon completion of multiple-precision operations.

Instruction Format:	15	14	13	12	11	10	9	8	7	6	5	4	3	2	1	0
	1	0	0	1	Register, Dx				1	1	0	0	0	Register, Dy		

Instruction Fields:

- Register Dx field—Specifies the destination data register, Dx.
- Register Dy field—Specifies the source data register, Dy.

SWAP

Swap Register Halves

SWAP

First appeared in ISA_A

Operation: Register[31:16] ↔ Register[15:0]

Assembler Syntax: SWAP.W Dx

Attributes: Size = Word

Description: Exchange the 16-bit words (halves) of a data register.

Condition Codes:	X	N	Z	V	C	X	Not affected
	—	*	*	0	0	N	Set if the msb of the result is set; cleared otherwise
						Z	Set if the result is zero; cleared otherwise
						V	Always cleared
						C	Always cleared

Instruction Format:	15	14	13	12	11	10	9	8	7	6	5	4	3	2	1	0
	0	1	0	0	1	0	0	0	0	1	0	0	0	Register, Dx		

Instruction Fields:

- Register field—Specifies the destination data register, Dx.

TAS

Test and Set an Operand First appeared in ISA_B

TAS

Operation: Destination Tested → CCR; 1 → bit 7 of Destination

Assembler Syntax: TAS.B <ea>x

Attributes: Size = byte

Description: Tests and sets the byte operand addressed by the effective address field. The instruction tests the current value of the operand and sets CCR[N] and CCR[Z] appropriately. TAS also sets the high-order bit of the operand. The operand uses a read-modify-write memory cycle that completes the operation without interruption. This instruction supports use of a flag or semaphore to coordinate several processors. Note that, unlike 68K Family processors, Dx is not a supported addressing mode.

Condition Codes:	X	N	Z	V	C	X	Not affected
	—	*	*	0	0	N	Set if the msb of the operand was set; cleared otherwise
						Z	Set if the operand was zero; cleared otherwise
						V	Always cleared
						C	Always cleared

Instruction Format:	15	14	13	12	11	10	9	8	7	6	5	4	3	2	1	0
	0	1	0	0	1	0	1	0	1	1	Destination Effective Address					
											Mode		Register			

Instruction Fields:

- Destination Effective Address field—Specifies the destination location, <ea>x; the possible data alterable addressing modes are listed in the table below.

Addressing Mode	Mode	Register	Addressing Mode	Mode	Register
Dx	—	—	(xxx).W	111	000
Ax	—	—	(xxx).L	111	001
(Ax)	010	reg. number:Ax	#<data>	—	—
(Ax) +	011	reg. number:Ax			
– (Ax)	100	reg. number:Ax			
(d ₁₆ ,Ax)	101	reg. number:Ax	(d ₁₆ ,PC)	—	—
(d ₈ ,Ax,Xi)	110	reg. number:Ax	(d ₈ ,PC,Xi)	—	—

TPF

Trap False

TPF

First appeared in ISA_A

Operation: No Operation

Assembler Syntax: TPF PC + 2 → PC
 TPF.W #<data> PC + 4 → PC
 TPF.L #<data> PC + 6 → PC

Attributes: Size = unsized, word, longword

Description: Performs no operation. TPF can occupy 16, 32, or 48 bits in instruction space, effectively providing a variable-length, single-cycle, no operation instruction. When code alignment is desired, TPF is preferred over the NOP instruction, as the NOP instruction also synchronizes the processor pipeline, resulting in multiple-cycle operation.

TPF.{W,L} can be used for elimination of unconditional branches, for example:

```

if (a == b)
    z = 1;
else
    z = 2;

```

which typically compiles to:

```

    cmp.l    d0,d1          ; compare a == b
    beq.b   label0        ; branch if equal
    movq.l  #2,d2         ; z = 2
    bra.b   label1        ; continue
label0:
    movq.l  #1,d2         ; z = 1
label1:

```

For this type of sequence, the BRA.B instruction can be replaced with a TPF.W or TPF.L opcode (depending on the length of the instruction at label0 - in this case, a TPF.W opcode would be applicable). The instruction(s) at the first label effectively become packaged as extension words of the TPF instruction, and the branch is completely eliminated.

Condition Codes: Not affected

Instruction	15	14	13	12	11	10	9	8	7	6	5	4	3	2	1	0
Format:	0	1	0	1	0	0	0	1	1	1	1	1	1	Opcode		
	Optional Immediate Word															
	Optional Immediate Word															

Instruction Fields:

- Opcode field—Specifies the number of optional extension words.
 - 010 one extension word
 - 011 two extension words
 - 100 no extension words

TRAP

Trap

First appeared in ISA_A

TRAP

Operation: 1 → S-Bit of SR
SP - 4 → SP; nextPC → (SP); SP - 2 → SP;
SR → (SP); SP - 2 → SP; Format/Offset → (SP);
(VBR + 0x80 + 4*n) → PC
where n is the TRAP vector number

Assembler Syntax: TRAP #<vector>

Attributes: Unsized

Description: Causes a TRAP #<vector> exception. The TRAP vector field is multiplied by 4 and then added to 0x80 to form the exception address. The exception address is then added to the VBR to index into the exception vector table. The vector field value can be 0 – 15, providing 16 vectors.

Note when SR is copied onto the exception stack frame, it represents the value at the beginning of the TRAP instruction's execution. At the conclusion of the exception processing, the SR is updated to clear the T bit and set the S bit.

Condition Codes: Not affected

Instruction Format:	15	14	13	12	11	10	9	8	7	6	5	4	3	2	1	0
	0	1	0	0	1	1	1	0	0	1	0	0	Vector			

Instruction Fields:

- Vector field—Specifies the trap vector to be taken.

TST

Test an Operand First appeared in ISA_A

TST

Operation: Source Operand Tested → CCR

Assembler Syntax: TST.sz <ea>y

Attributes: Size = byte, word, longword

Description: Compares the operand with zero and sets the condition codes according to the results of the test. The size of the operation is specified as byte, word, or longword.

Condition Codes:	X	N	Z	V	C	X	Not affected
	—	*	*	0	0	N	Set if the operand is negative; cleared otherwise
						Z	Set if the operand was zero; cleared otherwise
						V	Always cleared
						C	Always cleared

Instruction Format:	15	14	13	12	11	10	9	8	7	6	5	4	3	2	1	0
	0	1	0	0	1	0	1	0	Size		Destination Effective Address					
											Mode			Register		

Instruction Fields:

- Size field—Specifies the size of the operation:
 - 00 byte operation
 - 01 word operation
 - 10 longword operation
 - 11 word operation
- Destination Effective Address field—Specifies the addressing mode for the destination operand, <ea>x, as listed in the following table:

Addressing Mode	Mode	Register	Addressing Mode	Mode	Register
Dx	000	reg. number:Dx	(xxx).W	111	000
Ax*	001	reg. number:Ax	(xxx).L	111	001
(Ax)	010	reg. number:Ax	#<data>	111	100
(Ax) +	011	reg. number:Ax			
– (Ax)	100	reg. number:Ax			
(d ₁₆ ,Ax)	101	reg. number:Ax	(d ₁₆ ,PC)	111	010
(d ₈ ,Ax,Xi)	110	reg. number:Ax	(d ₈ ,PC,Xi)	111	011

* The Ax addressing mode is allowed only for word and longword operations.

UNLK

Unlink

UNLK

First appeared in ISA_A

Operation: $Ax \rightarrow SP; (SP) \rightarrow Ax; SP + 4 \rightarrow SP$

Assembler Syntax: UNLK Ax

Attributes: Unsized

Description: Loads the stack pointer from the specified address register, then loads the address register with the longword pulled from the top of the stack.

Condition Codes: Not affected

Instruction Format:	15	14	13	12	11	10	9	8	7	6	5	4	3	2	1	0
	0	1	0	0	1	1	1	0	0	1	0	1	1	Register, Ax		

Instruction Field:

- Register field—Specifies the address register, Ax, for the instruction.

WDDATA

Write to Debug Data

First appeared in ISA_A

WDDATA

Operation: Source → DDATA Signal Pins

Assembler Syntax: WDDATA.sz <ea>y

Attributes: Size = byte, word, longword

Description: This instruction fetches the operand defined by the effective address and captures the data in the ColdFire debug module for display on the DDATA output pins. The size of the operand determines the number of nibbles displayed on the DDATA output pins. The value of the debug module configuration/status register (CSR) does not affect the operation of this instruction.

The execution of this instruction generates a processor status encoding matching the PULSE instruction (0x4) before the referenced operand is displayed on the DDATA outputs.

Condition Codes: Not affected

Instruction Format:	15	14	13	12	11	10	9	8	7	6	5	4	3	2	1	0
	1	1	1	1	1	0	1	1	Size		Source Effective Address					
											Mode		Register			

Instruction Fields:

- Size field—specifies the size of the operand data
 - 00 byte operation
 - 01 word operation
 - 10 longword operation
 - 11 reserved
- Source Effective Address field—Determines the addressing mode for the operand, <ea>y, to be written to the DDATA signal pins; use only those memory alterable addressing modes listed in the following table:

Addressing Mode	Mode	Register
Dy	—	—
Ay	—	—
(Ay)	010	reg. number: Ay
(Ay) +	011	reg. number: Ay
– (Ay)	100	reg. number: Ay
(d ₁₆ , Ay)	101	reg. number: Ay
(d ₈ , Ay, Xi)	110	reg. number: Ay

Addressing Mode	Mode	Register
(xxx).W	111	000
(xxx).L	111	001
#<data>	—	—
(d ₁₆ , PC)	—	—
(d ₈ , PC, Xi)	—	—



THIS PAGE INTENTIONALLY LEFT BLANK

Chapter 5

Multiply-Accumulate Unit (MAC) User Instructions

This chapter describes the user instructions for the optional multiply-accumulate (MAC) unit in the ColdFire family of processors. A detailed discussion of each instruction description is arranged in alphabetical order by instruction mnemonic.

For instructions implemented by the Enhanced Multiply-Accumulate Unit (EMAC), refer to [Chapter 6](#), “Enhanced Multiply-Accumulate Unit (EMAC) User Instructions.”

MAC

Multiply Accumulate

MAC

Operation: $ACC + (Ry * Rx) \{\ll \mid \gg\} SF \rightarrow ACC$

Assembler syntax: MAC.sz Ry.{U,L},Rx.{U,L}SF

Attributes: Size = word, longword

Description: Multiply two 16- or 32-bit numbers to yield a 32-bit result, then add this product, shifted as defined by the scale factor, to the accumulator. If 16-bit operands are used, the upper or lower word of each register must be specified.

Condition Codes (MACSR):

N	Z	V
*	*	*

N Set if the msb of the result is set; cleared otherwise
 Z Set if the result is zero; cleared otherwise
 V Set if an overflow is generated; unchanged otherwise

Instruction Format:

	15	14	13	12	11	10	9	8	7	6	5	4	3	2	1	0
	1	0	1	0	Register, Rx			0	0	Rx	0	0	Register, Ry			
	—	—	—	—	sz	Scale Factor		0	U/Lx	U/Ly	—	—	—	—	—	—

Instruction Fields:

- Register Rx[6,11–9] field— Specifies a source register operand, where 0x0 is D0,..., 0x7 is D7, 0x8 is A0,..., 0xF is A7. Note that bit 6 of the operation word is the msb of the register number field.
- Register Ry[3–0] field — Specifies a source register operand, where 0x0 is D0,..., 0x7 is D7, 0x8 is A0,..., 0xF is A7.
- sz field—Specifies the size of the input operands
 - 0 word
 - 1 longword
- Scale Factor field —Specifies the scale factor. This field is ignored when using fractional operands.
 - 00 none
 - 01 product << 1
 - 10 reserved
 - 11 product >> 1

Instruction Fields (continued):

- U/L_x—Specifies which 16-bit operand of the source register, R_x, is used for a word-sized operation.
 - 0 lower word
 - 1 upper word
- U/L_y—Specifies which 16-bit operand of the source register, R_y, is used for a word-sized operation.
 - 0 lower word
 - 1 upper word

MAC

Multiply Accumulate with Load

MAC

Operation: $ACC + (Ry * Rx) \{\ll \mid \gg\} SF \rightarrow ACC$
 $(\langle ea \rangle y) \rightarrow Rw$

Assembler syntax: MAC.sz Ry.{U,L},Rx.{U,L}SF,<ea>y&,Rw
 where & enables the use of the MASK

Attributes: Size = word, longword

Description: Multiply two 16- or 32-bit numbers to yield a 32-bit result, then add this product, shifted as defined by the scale factor, to the accumulator. If 16-bit operands are used, the upper or lower word of each register must be specified. In parallel with this operation, a 32-bit operand is fetched from the memory location defined by <ea>y and loaded into the destination register, Rw. If the MASK register is specified to be used, the <ea>y operand is ANDed with MASK prior to being used by the instruction.

Condition Codes (MACSR):

N	Z	V	N Set if the msb of the result is set; cleared otherwise
*	*	*	Z Set if the result is zero; cleared otherwise
			V Set if an overflow is generated; unchanged otherwise

Instruction Format:

15	14	13	12	11	10	9	8	7	6	5	4	3	2	1	0	
1	0	1	0	Register, Rw				0	1	Rw	Source Effective Address					
											Mode		Register			
Register, Rx				sz	Scale Factor		0	U/Lx	U/Ly	Mask	0	Register, Ry				

Instruction Fields:

- Register Rw[6,11–9] field— Specifies the destination register, Rw, where 0x0 is D0,..., 0x7 is D7, 0x8 is A0,..., 0xF is A7. Note that bit 6 of the operation word is the msb of the register number field.
- Source Effective Address field specifies the source operand, <ea>y; use addressing modes in the following table:

Addressing Mode	Mode	Register	Addressing Mode	Mode	Register
Dy	—	—	(xxx).W	—	—
Ay	—	—	(xxx).L	—	—
(Ay)	010	reg. number: Ay	#<data>	—	—
(Ay) +	011	reg. number: Ay			
– (Ay)	100	reg. number: Ay			
(d ₁₆ ,Ay)	101	reg. number: Ay	(d ₁₆ ,PC)	—	—
(d ₈ ,Ay,Xi)	—	—	(d ₈ ,PC,Xi)	—	—

Instruction Fields (continued):

- Register Rx field — Specifies a source register operand, where 0x0 is D0,..., 0x7 is D7, 0x8 is A0,..., 0xF is A7.
- sz field—Specifies the size of the input operands
 - 0 word
 - 1 longword
- Scale Factor field—Specifies the scale factor. This field is ignored when using fractional operands.
 - 00 none
 - 01 product $\ll 1$
 - 10 reserved
 - 11 product $\gg 1$
- U/Lx, U/Ly—Specifies which 16-bit operand of the source register, Rx/Ry, is used for a word-sized operation.
 - 0 lower word
 - 1 upper word
- Mask field — Specifies whether or not to use the MASK register in generating the source effective address, <ea>y.
 - 0 do not use MASK
 - 1 use MASK
- Register Ry field — Specifies a source register operand, where 0x0 is D0,..., 0x7 is D7, 0x8 is A0,..., 0xF is A7.

MOVE from ACC

Move from
Accumulator

MOVE from ACC

Operation: Accumulator → Destination

Assembler syntax: MOVE.L ACC,Rx

Attributes: Size = longword

Description: Moves a 32-bit value from the accumulator into a general-purpose register, Rx. When operating in fractional mode (MACSR[F/I] = 1), if MACSR[S/U] is set, the accumulator contents are rounded to a 16-bit value and stored in the lower 16-bits of the destination register Rx. The upper 16 bits of the destination register are zero-filled. The value of the accumulator is not affected by this rounding operation.

MACSR: Not affected

Instruction Format:	15	14	13	12	11	10	9	8	7	6	5	4	3	2	1	0
	1	0	1	0	0	0	0	1	1	0	0	0	Register, Rx			

Instruction Field:

- Register Rx field — Specifies a destination register operand, where 0x0 is D0, ..., 0x7 is D7, 0x8 is A0, ..., 0xF is A7.

MOVE from MACSR

Move from the
MACSR

MOVE from MACSR

Operation: MACSR → Destination

Assembler Syntax: MOVE.L MACSR,Rx

Attributes: Size = longword

Description: Moves the MACSR register contents into a general-purpose register, Rx. Rx[31:8] are cleared.

MACSR: Not affected

Instruction Format:	15	14	13	12	11	10	9	8	7	6	5	4	3	2	1	0
	1	0	1	0	1	0	0	1	1	0	0	0	Register, Rx			

Instruction Field:

- Register Rx field — Specifies a source register operand, where 0x0 is D0, ..., 0x7 is D7, 0x8 is A0, ..., 0xF is A7.

MOVE from MASK

Move from the
MAC MASK Register

MOVE from MASK

Operation: MASK → Destination

Assembler Syntax: MOVE.L MASK,Rx

Attributes: Size = longword

Description: Moves the MASK register contents into a general-purpose register, Rx. Rx[31:16] are set to 0xFFFF.

MACSR: Not affected

Instruction Format:	15	14	13	12	11	10	9	8	7	6	5	4	3	2	1	0
	1	0	1	0	1	1	0	1	1	0	0	0	Register, Rx			

Instruction Field:

- Register Rx field — Specifies a source register operand, where 0x0 is D0, ..., 0x7 is D7, 0x8 is A0, ..., 0xF is A7.

MOVE MACSR to CCR

Move from the
MACSR to the CCR

MOVE MACSR to CCR

Operation: MACSR → CCR

Assembler Syntax: MOVE.L MACSR,CCR

Attributes: Size = longword

Description: Moves the MACSR condition codes into the Condition Code Register. The opcode for MOVE MACSR to CCR is 0xA9C0.

MACSR: Not affected

**Condition
Codes:**

X	N	Z	V	C
0	*	*	*	0

X Always cleared
N Set if MACSR[N]=1; cleared otherwise
Z Set if MACSR[Z]=1; cleared otherwise
V Set if MACSR[V]=1; cleared otherwise
C Always cleared

**Instruction
Format:**

15	14	13	12	11	10	9	8	7	6	5	4	3	2	1	0
1	0	1	0	1	0	0	1	1	1	0	0	0	0	0	0

MOVE to ACC

Move to Accumulator

MOVE to ACC

Operation: Source → Accumulator

Assembler syntax: MOVE.L Ry,ACC
MOVE.L #<data>,ACC

Attributes: Size = longword

Description: Moves a 32-bit value from a register or an immediate operand into the accumulator.

Condition Codes (MACSR):

N	Z	V	N Set if the msb of the result is set; cleared otherwise
*	*	0	Z Set if the result is zero; cleared otherwise
			V Always cleared

Instruction Format:

15	14	13	12	11	10	9	8	7	6	5	4	3	2	1	0
1	0	1	0	0	0	0	1	0	0	Source Effective Address					
										Mode		Register			

Instruction Fields:

- Source Effective Address field— Specifies the source operand, <ea>y; use addressing modes listed in the following table:

Addressing Mode	Mode	Register	Addressing Mode	Mode	Register
Dy	000	reg. number:Dy	(xxx).W	—	—
Ay	001	reg. number:Ay	(xxx).L	—	—
(Ay)	—	—	#<data>	111	100
(Ay) +	—	—			
– (Ay)	—	—			
(d ₁₆ ,Ay)	—	—	(d ₁₆ ,PC)	—	—
(d ₈ ,Ay,Xi)	—	—	(d ₈ ,PC,Xi)	—	—

MOVE to MACSR

Move to the MAC Status Register

MOVE to MACSR

Operation: Source → MACSR

Assembler Syntax: MOVE.L Ry,MACSR
MOVE.L #<data>,MACSR

Attributes: Size = longword

Description: Moves a 32-bit value from a register or an immediate operand into the MACSR.

MACSR:

	15	14	13	12	11	10	9	8	7	6	5	4	3	2	1	0
	—	—	—	—	—	—	—	—	OMC	S/U	F/I	R/T	N	Z	V	—
Source <ea> bit:	—	—	—	—	—	—	—	—	[7]	[6]	[5]	[4]	[3]	[2]	[1]	—

Instruction Format:

	15	14	13	12	11	10	9	8	7	6	5	4	3	2	1	0
	1	0	1	0	1	0	0	1	0	0	Source Effective Address					
											Mode		Register			

Instruction Fields:

- Source Effective Address field— Specifies the source operand; use addressing modes listed in the following table:

Addressing Mode	Mode	Register	Addressing Mode	Mode	Register
Dy	000	reg. number:Dy	(xxx).W	—	—
Ay	001	reg. number:Ay	(xxx).L	—	—
(Ay)	—	—	#<data>	111	100
(Ay) +	—	—			
– (Ay)	—	—			
(d ₁₆ ,Ay)	—	—	(d ₁₆ ,PC)	—	—
(d ₈ ,Ay,Xi)	—	—	(d ₈ ,PC,Xi)	—	—

MOVE to MASK

Move to the MAC MASK Register

MOVE to MASK

Operation: Source → MASK

Assembler Syntax: MOVE.L Ry,MASK
MOVE.L #<data>,MASK

Attributes: Size = longword

Description: Moves a 16-bit value from the lower word of a register or an immediate operand into the MASK register.

MACSR: Not affected

Instruction Format:

15	14	13	12	11	10	9	8	7	6	5	4	3	2	1	0
1	0	1	0	1	1	0	1	0	0	Source Effective Address					
										Mode		Register			

Instruction Fields:

- Source Effective Address field— Specifies the source operand; use addressing modes listed in the following table:

Addressing Mode	Mode	Register	Addressing Mode	Mode	Register
Dy	000	reg. number:Dy	(xxx).W	—	—
Ay	001	reg. number:Ay	(xxx).L	—	—
(Ay)	—	—	#<data>	111	100
(Ay) +	—	—			
– (Ay)	—	—			
(d ₁₆ ,Ay)	—	—	(d ₁₆ ,PC)	—	—
(d ₈ ,Ay,Xi)	—	—	(d ₈ ,PC,Xi)	—	—

MSAC

Multiply Subtract

MSAC

Operation: $ACC - (Ry * Rx)\{\ll | \gg\} SF \rightarrow ACC$

Assembler syntax: MSAC.sz Ry.{U,L},Rx.{U,L}SF

Attributes: Size = word, longword

Description: Multiply two 16- or 32-bit numbers to yield a 32-bit result, then subtract this product, shifted as defined by the scale factor, from the accumulator. If 16-bit operands are used, the upper or lower word of each register must be specified.

Condition Codes (MACSR):

N	Z	V
*	*	*

N Set if the msb of the result is set; cleared otherwise
 Z Set if the result is zero; cleared otherwise
 V Set if an overflow is generated; unchanged otherwise

Instruction Format:

	15	14	13	12	11	10	9	8	7	6	5	4	3	2	1	0	
	1	0	1	0	Register, Rx				0	0	Rx	0	0	Register, Ry			
	—	—	—	—	sz	Scale Factor		1	U/Lx	U/Ly	—	—	—	—	—	—	

Instruction Fields:

- Register Rx[6,11–9] field— Specifies a source register operand, where 0x0 is D0,..., 0x7 is D7, 0x8 is A0,..., 0xF is A7. Note that bit 6 of the operation word is the msb of the register number field.
- Register Ry[3–0] field — Specifies a source register operand, where 0x0 is D0,..., 0x7 is D7, 0x8 is A0,..., 0xF is A7.
- sz field—Specifies the size of the input operands
 - 0 word
 - 1 longword
- Scale Factor field —Specifies the scale factor. This field is ignored when using fractional operands.
 - 00 none
 - 01 product << 1
 - 10 reserved
 - 11 product >> 1

Instruction Fields (continued):

- U/L_x—Specifies which 16-bit operand of the source register, R_x, is used for a word-sized operation.
 - 0 lower word
 - 1 upper word
- U/L_y—Specifies which 16-bit operand of the source register, R_y, is used for a word-sized operation.
 - 0 lower word
 - 1 upper word

MSAC

Multiply Subtract with Load

MSAC

Operation: $ACC - (Ry * Rx)\{\ll | \gg\} SF \rightarrow ACC$
 $(\langle ea \rangle y) \rightarrow Rw$

Assembler syntax: MSAC.sz Ry.{U,L},Rx.{U,L}SF,<ea>y&,Rw
 where & enables the use of the MASK

Attributes: Size = word, longword

Description: Multiply two 16- or 32-bit numbers to yield a 32-bit result, then subtract this product, shifted as defined by the scale factor, from the accumulator. If 16-bit operands are used, the upper or lower word of each register must be specified. In parallel with this operation, a 32-bit operand is fetched from the memory location defined by <ea>y and loaded into the destination register, Rw. If the MASK register is specified to be used, the <ea>y operand is ANDed with MASK prior to being used by the instruction.

Condition Codes (MACSR):

N	Z	V
*	*	*

N Set if the msb of the result is set; cleared otherwise
 Z Set if the result is zero; cleared otherwise
 V Set if an overflow is generated; unchanged otherwise

Instruction Format:

15	14	13	12	11	10	9	8	7	6	5	4	3	2	1	0	
1	0	1	0	Register, Rw				0	1	Rw	Source Effective Address					
				Mode		Register										
Register, Rx				sz	Scale Factor	1	U/Lx	U/Ly	Mask	0	Register, Ry					

Instruction Fields:

- Register Rw[6,11–9] field— Specifies the destination register, Rw, where 0x0 is D0,..., 0x7 is D7, 0x8 is A0,..., 0xF is A7. Note that bit 6 of the operation word is the msb of the register number field.
- Source Effective Address field specifies the source operand, <ea>y; use addressing modes in the following table:

Addressing Mode	Mode	Register	Addressing Mode	Mode	Register
Dy	—	—	(xxx).W	—	—
Ay	—	—	(xxx).L	—	—
(Ay)	010	reg. number: Ay	#<data>	—	—
(Ay) +	011	reg. number: Ay			
– (Ay)	100	reg. number: Ay			
(d ₁₆ ,Ay)	101	reg. number: Ay	(d ₁₆ ,PC)	—	—
(d ₈ ,Ay,Xi)	—	—	(d ₈ ,PC,Xi)	—	—

Instruction Fields (continued):

- Register Rx field — Specifies a source register operand, where 0x0 is D0,..., 0x7 is D7, 0x8 is A0,..., 0xF is A7.
- sz field—Specifies the size of the input operands
 - 0 word
 - 1 longword
- Scale Factor field—Specifies the scale factor. This field is ignored when using fractional operands.
 - 00 none
 - 01 product $\ll 1$
 - 10 reserved
 - 11 product $\gg 1$
- U/Lx, U/Ly—Specifies which 16-bit operand of the source register, Rx/Ry, is used for a word-sized operation.
 - 0 lower word
 - 1 upper word
- Mask field — Specifies whether or not to use the MASK register in generating the source effective address, <ea>y.
 - 0 do not use MASK
 - 1 use MASK
- Register Ry field — Specifies a source register operand, where 0x0 is D0,..., 0x7 is D7, 0x8 is A0,..., 0xF is A7.

Chapter 6

Enhanced Multiply-Accumulate Unit (EMAC) User Instructions

This chapter describes the user instructions for the optional enhanced multiply-accumulate (EMAC) unit in the ColdFire family of processors. A detailed discussion of each instruction description is arranged in alphabetical order by instruction mnemonic. This chapter includes descriptions for the original EMAC instruction set as well as four dual-accumulation instructions (MAAAC, MASAC, MSAAC, MSSAC) which first appeared in Revision B of the EMAC definition.

For instructions implemented by the Multiply-Accumulate Unit (MAC), refer to [Chapter 5, “Multiply-Accumulate Unit \(MAC\) User Instructions.”](#)

MAAAC

Multiply and Add to First Accumulator, Add to Second Accumulator

First appeared in EMAC_B

MAAAC

Operation: $ACCx + (Ry * Rx)\{\ll | \gg\} SF \rightarrow ACCx$
 $ACCw + (Ry * Rx)\{\ll | \gg\} SF \rightarrow ACCw$

Assembler syntax: MAAAC.sz Ry,RxSF,ACCx,ACCw

Attributes: Size = word, longword

Description: Multiply two 16 or 32-bit numbers to produce a 40-bit result, then add this product, shifted as defined by the scale factor, to an accumulator, ACCx, and also add it to another accumulator, ACCw.

Condition Codes (MACSR):

N	Z	V	PAVx	EV
*	*	*	*	*

N Set if the msb of the secondary result is set; cleared otherwise
Z Set if the secondary result is zero; cleared otherwise
V Set if a product or secondary accumulation overflow is generated or PAVw=1; cleared otherwise
PAVx,w Set if any product or accumulation overflow is generated; unchanged otherwise
EV Set if secondary accumulation overflows lower 32 bits in integer mode or lower 40 bits in fractional mode; cleared otherwise

Instruction Format:

15	14	13	12	11	10	9	8	7	6	5	4	3	2	1	0
1	0	1	0	Register, Rx			0	ACCx lsb	Rx msb	0	0	Register, Ry			
—	—	—	—	sz	Scale Factor		0	U/Lx	U/Ly	—	ACCx msb	ACCw	0	1	

Instruction Fields:

- Register Rx[6,11–9] field— Specifies a source register operand, where 0x0 is D0,..., 0x7 is D7, 0x8 is A0,..., 0xF is A7. Note that bit 6 of the operation word is the msb of the register number field.
- ACCx field— Specifies the first destination accumulator, ACCx. Bit 4 of the extension word is the msb and bit 7 of the operation word is the lsb. The value of these two bits specify the accumulator number as shown in the following table:

Extword [4]	Op word [7]	Accumulator
0	0	ACC0
0	1	ACC1
1	0	ACC2
1	1	ACC3

Instruction Fields (continued):

- Register Ry[3–0] field — Specifies a source register operand, where 0x0 is D0,..., 0x7 is D7, 0x8 is A0,..., 0xF is A7.
- sz field—Specifies the size of the input operands
 - 0 word
 - 1 longword
- Scale Factor field—Specifies the scale factor. This field is ignored when using fractional operands.
 - 00 none
 - 01 product $\ll 1$
 - 10 reserved
 - 11 product $\gg 1$
- U/Lx—Specifies which 16-bit operand of the source register, Rx, is used for a word-sized operation.
 - 0 lower word
 - 1 upper word
- U/Ly—Specifies which 16-bit operand of the source register, Ry, is used for a word-sized operation.
 - 0 lower word
 - 1 upper word
- ACCw field—Specifies the second destination accumulator, ACCw. 00 = Accumulator 0; 11 = Accumulator 3.

MAC

Multiply Accumulate

MAC

Operation: $ACCx + (Ry * Rx)\{\ll\ |\ \gg\} SF \rightarrow ACCx$

Assembler syntax: MAC.sz Ry.{U,L},Rx.{U,L}SF,ACCx

Attributes: Size = word, longword

Description: Multiply two 16- or 32-bit numbers to yield a 40-bit result, then add this product, shifted as defined by the scale factor, to an accumulator. If 16-bit operands are used, the upper or lower word of each register must be specified.

Condition Codes (MACSR):

N	Z	V	PAVx	EV
*	*	*	*	*

N Set if the msb of the result is set; cleared otherwise
 Z Set if the result is zero; cleared otherwise
 V Set if a product or accumulation overflow is generated or PAVx=1; cleared otherwise
 PAVx Set if a product or accumulation overflow is generated; unchanged otherwise
 EV Set if accumulation overflows lower 32 bits in integer mode or lower 40 bits in fractional mode; cleared otherwise

Instruction Format:

15	14	13	12	11	10	9	8	7	6	5	4	3	2	1	0	
1	0	1	0	Register, Rx				0	ACC lsb	Rx msb	0	0	Register, Ry			
—	—	—	—	sz	Scale Factor		0	U/Lx	U/Ly	—	ACC msb	—	—	—	—	

Instruction Fields:

- Register Rx[6,11–9] field— Specifies a source register operand, where 0x0 is D0,..., 0x7 is D7, 0x8 is A0,..., 0xF is A7. Note that bit 6 of the operation word is the msb of the register number field.
- ACC field— Specifies the destination accumulator, ACCx. Bit 4 of the extension word is the msb and bit 7 of the operation word is the lsb. The value of these two bits specify the accumulator number as shown in the following table:

Extword [4]	Op word [7]	Accumulator
0	0	ACC0
0	1	ACC1
1	0	ACC2
1	1	ACC3

- Register Ry[3–0] field — Specifies a source register operand, where 0x0 is D0,..., 0x7 is D7, 0x8 is A0,..., 0xF is A7.

Instruction Fields (continued):

- sz field—Specifies the size of the input operands
 - 0 word
 - 1 longword
- Scale Factor field —Specifies the scale factor. This field is ignored when using fractional operands.
 - 00 none
 - 01 product $\ll 1$
 - 10 reserved
 - 11 product $\gg 1$
- U/Lx—Specifies which 16-bit operand of the source register, Rx, is used for a word-sized operation.
 - 0 lower word
 - 1 upper word
- U/Ly—Specifies which 16-bit operand of the source register, Ry, is used for a word-sized operation.
 - 0 lower word
 - 1 upper word

MAC

Multiply Accumulate with Load

MAC

Operation: $ACCx + (Ry * Rx) \{\ll\mid\gg\} SF \rightarrow ACCx$
 $(\langle ea \rangle y) \rightarrow Rw$

Assembler syntax: MAC.sz Ry.{U,L},Rx.{U,L}SF,<ea>y&,Rw,ACCx
 where & enables the use of the MASK

Attributes: Size = word, longword

Description: Multiply two 16- or 32-bit numbers to yield a 40-bit result, then add this product, shifted as defined by the scale factor, to an accumulator. If 16-bit operands are used, the upper or lower word of each register must be specified. In parallel with this operation, a 32-bit operand is fetched from the memory location defined by <ea>y and loaded into the destination register, Rw. If the MASK register is specified to be used, the <ea>y operand is ANDed with MASK prior to being used by the instruction.

Condition Codes (MACSR):

N	Z	V	PAVx	EV
*	*	*	*	*

N Set if the msb of the result is set; cleared otherwise
 Z Set if the result is zero; cleared otherwise
 V Set if a product or accumulation overflow is generated or PAVx=1; cleared otherwise
 PAVxSet if a product or accumulation overflow is generated; unchanged otherwise
 EV Set if accumulation overflows lower 32 bits (integer) or lower 40 bits (fractional); cleared otherwise

Instruction Format:

15	14	13	12	11	10	9	8	7	6	5	4	3	2	1	0	
1	0	1	0	Register, Rw				0	ACC lsb	Rw msb	Source Effective Address					
				Mode		Register										
Register, Rx				sz	Scale Factor	0	U/Lx	U/Ly	Mask	ACC msb	Register, Ry					

Instruction Fields:

- Register Rw[6,11–9] field— Specifies the destination register, Rw, where 0x0 is D0,..., 0x7 is D7, 0x8 is A0,..., 0xF is A7. Note that bit 6 of the operation word is the msb of the register number field.
- ACC field—Specifies the destination accumulator, ACCx. Bit 4 of the extension word is the msb and bit 7 of the operation word is the inverse of the lsb (unlike the MAC instruction without a load). The value of these two bits specify the accumulator number as shown in the following table:

Ext word [4]	Op word [7]	Accumulator
0	1	ACC0
0	0	ACC1
1	1	ACC2
1	0	ACC3

Instruction Fields (continued):

- Source Effective Address field specifies the source operand, <ea>y; use addressing modes in the following table:

Addressing Mode	Mode	Register	Addressing Mode	Mode	Register
Dy	—	—	(xxx).W	—	—
Ay	—	—	(xxx).L	—	—
(Ay)	010	reg. number: Ay	#<data>	—	—
(Ay) +	011	reg. number: Ay			
– (Ay)	100	reg. number: Ay			
(d ₁₆ , Ay)	101	reg. number: Ay	(d ₁₆ , PC)	—	—
(d ₈ , Ay, Xi)	—	—	(d ₈ , PC, Xi)	—	—

- Register Rx field — Specifies a source register operand, where 0x0 is D0, ..., 0x7 is D7, 0x8 is A0, ..., 0xF is A7.
- sz field—Specifies the size of the input operands
 - 0 word
 - 1 longword
- Scale Factor field — Specifies the scale factor. This field is ignored when using fractional operands.
 - 00 none
 - 01 product << 1
 - 10 reserved
 - 11 product >> 1
- U/Lx, U/Ly—Specifies which 16-bit operand of the source register, Rx/Ry, is used for a word-sized operation.
 - 0 lower word
 - 1 upper word
- Mask field — Specifies whether or not to use the MASK register in generating the source effective address, <ea>y.
 - 0 do not use MASK
 - 1 use MASK
- Register Ry field — Specifies a source register operand, where 0x0 is D0, ..., 0x7 is D7, 0x8 is A0, ..., 0xF is A7.

MASAC

Multiply and Add to First Accumulator, Subtract from Second Accumulator

First appeared in EMAC_B

MASAC

Operation: $ACCx + (Ry * Rx)\{\ll | \gg\} SF \rightarrow ACCx$
 $ACCw - (Ry * Rx)\{\ll | \gg\} SF \rightarrow ACCw$

Assembler syntax: MASAC.sz Ry,RxSF,ACCx,ACCw

Attributes: Size = word, longword

Description: Multiply two 16 or 32-bit numbers to produce a 40-bit result, then add this product, shifted as defined by the scale factor, to an accumulator, ACCx. Subtract the product, shifted as defined by the scale factor, from another accumulator, ACCw.

Condition Codes (MACSR):

N	Z	V	PAVx	EV
*	*	*	*	*

N Set if the msb of the secondary result is set; cleared otherwise
Z Set if the secondary result is zero; cleared otherwise
V Set if a product or secondary accumulation overflow is generated or PAVw=1; cleared otherwise
PAVx,w Set if any product or accumulation overflow is generated; unchanged otherwise
EV Set if secondary accumulation overflows lower 32 bits in integer mode or lower 40 bits in fractional mode; cleared otherwise

Instruction Format:

15	14	13	12	11	10	9	8	7	6	5	4	3	2	1	0
1	0	1	0	Register, Rx			0	ACCx lsb	Rx msb	0	0	Register, Ry			
—	—	—	—	sz	Scale Factor		0	U/Lx	U/Ly	—	ACCx msb	ACCw	1	1	

Instruction Fields:

- Register Rx[6,11–9] field— Specifies a source register operand, where 0x0 is D0, ..., 0x7 is D7, 0x8 is A0, ..., 0xF is A7. Note that bit 6 of the operation word is the msb of the register number field.
- ACCx field— Specifies the first destination accumulator, ACCx. Bit 4 of the extension word is the msb and bit 7 of the operation word is the lsb. The value of these two bits specify the accumulator number as shown in the following table:

Extword [4]	Op word [7]	Accumulator
0	0	ACC0
0	1	ACC1
1	0	ACC2
1	1	ACC3

Instruction Fields (continued):

- Register Ry[3–0] field — Specifies a source register operand, where 0x0 is D0,..., 0x7 is D7, 0x8 is A0,..., 0xF is A7.
- sz field—Specifies the size of the input operands
 - 0 word
 - 1 longword
- Scale Factor field—Specifies the scale factor. This field is ignored when using fractional operands.
 - 00 none
 - 01 product $\ll 1$
 - 10 reserved
 - 11 product $\gg 1$
- U/Lx—Specifies which 16-bit operand of the source register, Rx, is used for a word-sized operation.
 - 0 lower word
 - 1 upper word
- U/Ly—Specifies which 16-bit operand of the source register, Ry, is used for a word-sized operation.
 - 0 lower word
 - 1 upper word
- ACCw field—Specifies the second destination accumulator, ACCw. 00 = Accumulator 0; 11 = Accumulator 3.

MOVCLR

MOVCLR

Move from Accumulator and Clear

Operation: Accumulator → Destination; 0 → Accumulator

Assembler syntax: MOVCLR.L ACCy,Rx

Attributes: Size = longword

Description: Moves a 32-bit accumulator value into a general-purpose register, Rx. The selected accumulator is cleared after the store to the Rx register is complete. This clearing operation also affects the accumulator extension bytes and the product/accumulation overflow indicator. The store accumulator function is quite complex, and a function of the EMAC configuration defined by the MACSR. The following pseudocode defines its operation; in this description, ACC[47:0] represents the concatenation of the 32-bit accumulator and the 16-bit extension word.

```
if MACSR[S/U,F/I] == 00                                /* signed integer mode
    if MACSR[OMC] == 0
        then ACC[31:0] → Rx                            /* saturation disabled
        else if ACC[47:31] == 0x0000_0 or 0xFFFF_1
            then ACC[31:0] → Rx
            else if ACC[47] == 0
                then 0x7FFF_FFFF → Rx
                else 0x8000_0000 → Rx

if MACSR[S/U,F/I] == 10                                /* unsigned integer mode
    if MACSR[OMC] == 0
        then ACC[31:0] → Rx                            /* saturation disabled
        else if ACC[47:32] == 0x0000
            then ACC[31:0] → Rx
            else 0xFFFF_FFFF → Rx

if MACSR[F/I] == 1                                     /* signed fractional mode
    if MACSR[OMC,S/U,R/T] == 000                       /* no saturation, no 16-bit rnd, no 32-bit rnd
        then ACC[39:8] → Rx
    if MACSR[OMC,S/U,R/T] == 001                       /* no saturation, no 16-bit rnd, 32-bit rnd
        then ACC[39:8] rounded by contents of [7:0] → Rx
    if MACSR[OMC,S/U] == 01                             /* no saturation, 16-bit rounding
        then 0 → Rx[31:16]
            ACC[39:24] rounded by contents of [23:0] → Rx[15:0]
    if MACSR[OMC,S/U,R/T] == 100                       /* saturation, no 16-bit rnd, no 32-bit rnd
        if ACC[47:39] == 0x00_0 or 0xFF_1
            then ACC[39:8] → Rx
            else if ACC[47] == 0
                then 0x7FFF_FFFF → Rx
                else 0x8000_0000 → Rx
    if MACSR[OMC,S/U,R/T] == 101                       /* saturation, no 16-bit rnd, 32-bit rounding
        Temp[47:8] = ACC[47:8] rounded by contents of [7:0]
        if Temp[47:39] == 0x00_0 or 0xFF_1
```

```
then Temp[39:8] → Rx
else if Temp[47] == 0
    then 0x7FFF_FFFF → Rx
    else 0x8000_0000 → Rx
```

MOVCLR

MOVCLR

Move from Accumulator and Clear

```

if MACSR[OMC,S/U] == 11          /* saturation, 16-bit rounding
    Temp[47:24] = ACC[47:24] rounded by the contents of [23:0]
    if Temp[47:39] == 0x00_0 or 0xFF_1
        then 0 → Rx[31:16]
            Temp[39:24] → Rx[15:0]
        else if Temp[47] == 0
            then 0x0000_7FFF → Rx
            else 0x0000_8000 → Rx

```

0 → ACCx, ACCextx, MACSR[PAVx]

Condition Codes (MACSR):	N	Z	V	PAVx	EV	N Not affected
	—	—	—	0	—	Z Not affected
						V Not affected
						PAVxCleared
						EV Not affected

Instruction Format:	15	14	13	12	11	10	9	8	7	6	5	4	3	2	1	0
	1	0	1	0	0	ACC	1	1	1	0	0	Register, Rx				

Instruction Fields:

- ACC—Specifies the destination accumulator. The value of bits [10:9] specify the accumulator number.
- Register Rx field — Specifies a destination register operand, where 0x0 is D0,..., 0x7 is D7, 0x8 is A0,..., 0xF is A7.

MOVE from ACC

Move from Accumulator

MOVE from ACC

Operation: Accumulator → Destination

Assembler syntax: MOVE.L ACCy,Rx

Attributes: Size = longword

Description: Moves a 32-bit value from an accumulator into a general-purpose register, Rx.

The store accumulator function is quite complex, and a function of the EMAC configuration defined by the MACSR. The following pseudocode defines its operation; in this description, ACC[47:0] represents the concatenation of the 32-bit accumulator and the 16-bit extension word.

```
if MACSR[S/U,F/I] == 00                                /* signed integer mode
    if MACSR[OMC] == 0
        then ACC[31:0] → Rx                            /* saturation disabled
        else if ACC[47:31] == 0x0000_0 or 0xFFFF_1
            then ACC[31:0] → Rx
            else if ACC[47] == 0
                then 0x7FFF_FFFF → Rx
                else 0x8000_0000 → Rx

if MACSR[S/U,F/I] == 10                                /* unsigned integer mode
    if MACSR[OMC] == 0
        then ACC[31:0] → Rx                            /* saturation disabled
        else if ACC[47:32] == 0x0000
            then ACC[31:0] → Rx
            else 0xFFFF_FFFF → Rx

if MACSR[F/I] == 1                                     /* signed fractional mode
    if MACSR[OMC,S/U,R/T] == 000                       /* no saturation, no 16-bit rnd, no 32-bit rnd
        then ACC[39:8] → Rx
    if MACSR[OMC,S/U,R/T] == 001                       /* no saturation, no 16-bit rnd, 32-bit rnd
        then ACC[39:8] rounded by contents of [7:0] → Rx
    if MACSR[OMC,S/U] == 01                            /* no saturation, 16-bit rounding
        then 0 → Rx[31:16]
            ACC[39:24] rounded by contents of [23:0] → Rx[15:0]
    if MACSR[OMC,S/U,R/T] == 100                       /* saturation, no 16-bit rnd, no 32-bit rnd
        if ACC[47:39] == 0x00_0 or 0xFF_1
            then ACC[39:8] → Rx
            else if ACC[47] == 0
                then 0x7FFF_FFFF → Rx
                else 0x8000_0000 → Rx

if MACSR[OMC,S/U,R/T] == 101                           /* saturation, no 16-bit rnd, 32-bit rounding
    Temp[47:8] = ACC[47:8] rounded by contents of [7:0]
    if Temp[47:39] == 0x00_0 or 0xFF_1
        then Temp[39:8] → Rx
        else if Temp[47] == 0
```

```
then 0x7FFF_FFFF → Rx  
else 0x8000_0000 → Rx
```

MOVE from ACC

Move from an Accumulator

MOVE from ACC

```

if MACSR[OMC,S/U] == 11          /* saturation, 16-bit rounding
    Temp[47:24] = ACC[47:24] rounded by the contents of [23:0]
    if Temp[47:39] == 0x00_0 or 0xFF_1
        then 0 → Rx[31:16]
            Temp[39:24] → Rx[15:0]
        else if Temp[47] == 0
            then 0x0000_7FFF → Rx
            else 0x0000_8000 → Rx

0 → ACCx, ACCextx, MACSR[PAVx]

```

**Condition
Codes
(MACSR):**

N	Z	V	PAVx	EV
—	—	—	—	—

N Not affected
 Z Not affected
 V Not affected
 PAVx Not affected
 EV Not affected

**Instruction
Format:**

15	14	13	12	11	10	9	8	7	6	5	4	3	2	1	0
1	0	1	0	0	ACC		1	1	0	0	0	Register, Rx			

Instruction Fields:

- **ACC**—Specifies the destination accumulator. The value of bits [10:9] specify the accumulator number.
- **Register Rx field** — Specifies a destination register operand, where 0x0 is D0,..., 0x7 is D7, 0x8 is A0,..., 0xF is A7.

MOVE from ACCext01

Move from Accumulator 0 and 1 Extensions

MOVE from ACCext01

Operation: Accumulator 0 and 1 extension words → Destination

Assembler syntax: MOVE.L ACCext01,Rx

Attributes: Size = longword

Description: Moves the contents of the four extension bytes associated with accumulators 0 and 1 into a general-purpose register. The accumulator extension bytes are stored as shown in the following table. Note the position of the LSB of the extension within the combined 48-bit accumulation logic is dependent on the operating mode of the EMAC (integer versus fractional).

Accumulator Extension Byte	Destination Data Bits
ACCext1[15:8]	[31:24]
ACCext1[7:0]	[23:16]
ACCext0[15:8]	[15:8]
ACCext0[7:0]	[7:0]

MACSR: Not affected

Instruction Format:

15	14	13	12	11	10	9	8	7	6	5	4	3	2	1	0
1	0	1	0	1	0	1	1	1	0	0	0	Register, Rx			

Instruction Field:

- Register Rx field — Specifies a source register operand, where 0x0 is D0,..., 0x7 is D7, 0x8 is A0,..., 0xF is A7.

MOVE from ACCext23

Move from Accumulator 2 and 3 Extensions

MOVE from ACCext23

Operation: Accumulator 2 and 3 extension words → Destination

Assembler syntax: MOVE.L ACCext23,Rx

Attributes: Size = longword

Description: Moves the contents of the four extension bytes associated with accumulators 2 and 3 into a general-purpose register. The accumulator extension bytes are stored as shown in the following table. Note the position of the LSB of the extension within the combined 48-bit accumulation logic is dependent on the operating mode of the EMAC (integer versus fractional).

Accumulator Extension Byte	Destination Data Bits
ACCext3[15:8]	[31:24]
ACCext3[7:0]	[23:16]
ACCext2[15:8]	[15:8]
ACCext2[7:0]	[7:0]

MACSR: Not affected

Instruction Format:

15	14	13	12	11	10	9	8	7	6	5	4	3	2	1	0
1	0	1	0	1	1	1	1	1	0	0	0	Register, Rx			

Instruction Field:

- Register Rx field — Specifies a source register operand, where 0x0 is D0,..., 0x7 is D7, 0x8 is A0,..., 0xF is A7.

MOVE from MACSR

Move from the
MACSR

MOVE from MACSR

Operation: MACSR → Destination

Assembler Syntax: MOVE.L MACSR,Rx

Attributes: Size = longword

Description: Moves the MACSR register contents into a general-purpose register, Rx. Rx[31:12] are cleared.

MACSR: Not affected

Instruction Format:	15	14	13	12	11	10	9	8	7	6	5	4	3	2	1	0
	1	0	1	0	1	0	0	1	1	0	0	0	Register, Rx			

Instruction Field:

- Register Rx field — Specifies a source register operand, where 0x0 is D0, ..., 0x7 is D7, 0x8 is A0, ..., 0xF is A7.

MOVE from MASK

Move from the
MAC MASK Register

MOVE from MASK

Operation: MASK → Destination

Assembler Syntax: MOVE.L MASK,Rx

Attributes: Size = longword

Description: Moves the MASK register contents into a general-purpose register, Rx. Rx[31:16] are set to 0xFFFF.

MACSR: Not affected

Instruction Format:	15	14	13	12	11	10	9	8	7	6	5	4	3	2	1	0
	1	0	1	0	1	1	0	1	1	0	0	0	Register, Rx			

Instruction Field:

- Register Rx field — Specifies a source register operand, where 0x0 is D0, ..., 0x7 is D7, 0x8 is A0, ..., 0xF is A7.

MOVE ACC to ACC

Copy an
Accumulator

MOVE ACC to ACC

Operation: Source Accumulator → Destination Accumulator

Assembler syntax: MOVE.L ACCy,ACCx

Attributes: Size = longword

Description: Moves the 48-bit source accumulator contents and its associated PAV flag into the destination accumulator. This operation is fully pipelined within the EMAC so no pipeline stalls are associated with it. This instruction provides better performance than the two-step process of moving an accumulator to a general-purpose register Rn, then moving Rn into the destination accumulator.

Condition Codes (MACSR):

N	Z	V	PAVx	EV
*	*	*	*	*

N Set if the msb of the result is set; cleared otherwise
 Z Set if the result is zero; cleared otherwise
 V Set if PAVy=1; cleared otherwise
 PAVx Set to the value of the source PAVy flag
 EV Set if the source accumulator overflows lower 32 bits in integer mode or lower 40 bits in fractional mode; cleared otherwise

Instruction Format:

15	14	13	12	11	10	9	8	7	6	5	4	3	2	1	0
1	0	1	0	0	ACCx		1	0	0	0	1	0	0	ACCy	

Instruction Fields:

- ACCx—Specifies the destination accumulator. The value of bits [10:9] specify the accumulator number.
- ACCy—Specifies the source accumulator. The value of bits [1:0] specify the accumulator number.

MOVE MACSR to CCR

MOVE MACSR to CCR

Move from the
MACSR to the CCR

Operation: MACSR → CCR

Assembler Syntax: MOVE.L MACSR,CCR

Attributes: Size = longword

Description: Moves the MACSR condition codes into the Condition Code Register. The opcode for MOVE MACSR to CCR is 0xA9C0.

MACSR: Not affected

**Condition
Codes:**

X	N	Z	V	C
0	*	*	*	*

- X Always cleared
- N Set if MACSR[N]=1; cleared otherwise
- Z Set if MACSR[Z]=1; cleared otherwise
- V Set if MACSR[V]=1; cleared otherwise
- C Set if MACSR[EV]=1; cleared otherwise

**Instruction
Format:**

15	14	13	12	11	10	9	8	7	6	5	4	3	2	1	0
1	0	1	0	1	0	0	1	1	1	0	0	0	0	0	0

MOVE to ACC

Move to Accumulator

MOVE to ACC

Operation: Source → Accumulator

Assembler syntax: MOVE.L Ry,ACCx
MOVE.L #<data>,ACCx

Attributes: Size = longword

Description: Moves a 32-bit value from a register or an immediate operand into an accumulator. If the EMAC is operating in signed integer mode (MACSR[6:5] = 00), the 16-bit accumulator extension is loaded with the sign-extension of bit 31 of the source operand, while operation in unsigned integer mode (MACSR[6:5] = 10) clears the entire 16-bit field. If operating in fractional mode (MACSR[5] = 1, the upper 8 bits of the accumulator extension are loaded with the sign-extension of bit 31 of the source operand, while the low-order 8-bits of the extension are cleared. The appropriate product/accumulation overflow bit is cleared.

Condition Codes (MACSR):

N	Z	V	PAVx	EV
*	*	0	0	0

N Set if the msb of the result is set; cleared otherwise
Z Set if the result is zero; cleared otherwise
V Always cleared
PAVx Always cleared
EV Always cleared

Instruction Format:

15	14	13	12	11	10	9	8	7	6	5	4	3	2	1	0
1	0	1	0	0	ACC	1	0	0	Source Effective Address						
									Mode			Register			

Instruction Fields:

- **ACC**—Specifies the destination accumulator. The value of bits [10:9] specify the accumulator number.
- **Source Effective Address field**— Specifies the source operand, <ea>y; use addressing modes listed in the following table:

Addressing Mode	Mode	Register	Addressing Mode	Mode	Register
Dy	000	reg. number:Dy	(xxx).W	—	—
Ay	001	reg. number:Ay	(xxx).L	—	—
(Ay)	—	—	#<data>	111	100
(Ay) +	—	—			
– (Ay)	—	—			
(d ₁₆ ,Ay)	—	—	(d ₁₆ ,PC)	—	—
(d ₈ ,Ay,Xi)	—	—	(d ₈ ,PC,Xi)	—	—

MOVE to ACCext01

Move to Accumulator
0 and 1 Extensions

MOVE to ACCext01

Operation: Source → Accumulator 0 and 1 extension words

Assembler syntax: MOVE.L Ry,ACCext01
MOVE.L #<data>,ACCext01

Attributes: Size = longword

Description: Moves a 32-bit value from a register or an immediate operand into the four extension bytes associated with accumulators 0 and 1. The accumulator extension bytes are loaded as shown in the following table. Note the position of the LSB of the extension within the combined 48-bit accumulation logic is dependent on the operating mode of the EMAC (integer versus fractional).

Source Data Bits	Accumulator Extension Affected
[31:24]	ACCext1[15:8]
[23:16]	ACCext1[7:0]
[15:8]	ACCext0[15:8]
[7:0]	ACCext0[7:0]

MACSR: Not affected

Instruction Format:

15	14	13	12	11	10	9	8	7	6	5	4	3	2	1	0
1	0	1	0	1	0	1	1	0	0	Source Effective Address					
										Mode		Register			

Instruction Fields:

- Source Effective Address field— Specifies the source operand; use addressing modes listed in the following table:

Addressing Mode	Mode	Register	Addressing Mode	Mode	Register
Dy	000	reg. number:Dy	(xxx).W	—	—
Ay	001	reg. number:Ay	(xxx).L	—	—
(Ay)	—	—	#<data>	111	100
(Ay) +	—	—			
– (Ay)	—	—			
(d ₁₆ ,Ay)	—	—	(d ₁₆ ,PC)	—	—
(d ₈ ,Ay,Xi)	—	—	(d ₈ ,PC,Xi)	—	—

MOVE to ACCext23

Move to Accumulator
2 and 3 Extensions

MOVE to ACCext23

Operation: Source → Accumulator 2 and 3 extension words

Assembler syntax: MOVE.L Ry,ACCext23
MOVE.L #<data>,ACCext23

Attributes: Size = longword

Description: Moves a 32-bit value from a register or an immediate operand into the four extension bytes associated with accumulators 2 and 3. The accumulator extension bytes are loaded as shown in the following table. Note the position of the LSB of the extension within the combined 48-bit accumulation logic is dependent on the operating mode of the EMAC (integer versus fractional).

Source Data Bits	Accumulator Extension Affected
[31:24]	ACCext3[15:8]
[23:16]	ACCext3[7:0]
[15:8]	ACCext2[15:8]
[7:0]	ACCext2[7:0]

MACSR: Not affected

Instruction Format:

15	14	13	12	11	10	9	8	7	6	5	4	3	2	1	0
1	0	1	0	1	1	1	1	0	0	Source Effective Address					
										Mode		Register			

Instruction Fields:

- Source Effective Address field— Specifies the source operand; use addressing modes listed in the following table:

Addressing Mode	Mode	Register	Addressing Mode	Mode	Register
Dy	000	reg. number:Dy	(xxx).W	—	—
Ay	001	reg. number:Ay	(xxx).L	—	—
(Ay)	—	—	#<data>	111	100
(Ay) +	—	—			
– (Ay)	—	—			
(d ₁₆ ,Ay)	—	—	(d ₁₆ ,PC)	—	—
(d ₈ ,Ay,Xi)	—	—	(d ₈ ,PC,Xi)	—	—

MOVE to MACSR

Move to the MAC Status Register

MOVE to MACSR

Operation: Source → MACSR

Assembler Syntax: MOVE.L Ry,MACSR
MOVE.L #<data>,MACSR

Attributes: Size = longword

Description: Moves a 32-bit value from a register or an immediate operand into the MACSR.

MACSR:

	15	14	13	12	11	10	9	8	7	6	5	4	3	2	1	0
	—	—	—	—	PAV3	PAV2	PAV1	PAV0	OMC	S/U	F/I	R/T	N	Z	V	EV
Source <ea> bit:	—	—	—	—	[11]	[10]	[9]	[8]	[7]	[6]	[5]	[4]	[3]	[2]	[1]	[0]

Instruction Format:

15	14	13	12	11	10	9	8	7	6	5	4	3	2	1	0
1	0	1	0	1	0	0	1	0	0	Source Effective Address					
										Mode		Register			

Instruction Fields:

- Source Effective Address field— Specifies the source operand; use addressing modes listed in the following table:

Addressing Mode	Mode	Register	Addressing Mode	Mode	Register
Dy	000	reg. number:Dy	(xxx).W	—	—
Ay	001	reg. number:Ay	(xxx).L	—	—
(Ay)	—	—	#<data>	111	100
(Ay) +	—	—			
– (Ay)	—	—			
(d ₁₆ ,Ay)	—	—	(d ₁₆ ,PC)	—	—
(d ₈ ,Ay,Xi)	—	—	(d ₈ ,PC,Xi)	—	—

MOVE to MASK

Move to the MAC MASK Register

MOVE to MASK

Operation: Source → MASK

Assembler Syntax: MOVE.L Ry,MASK
MOVE.L #<data>,MASK

Attributes: Size = longword

Description: Moves a 16-bit value from the lower word of a register or an immediate operand into the MASK register.

MACSR: Not affected

Instruction Format:

15	14	13	12	11	10	9	8	7	6	5	4	3	2	1	0
1	0	1	0	1	1	0	1	0	0	Source Effective Address					
										Mode		Register			

Instruction Fields:

- Source Effective Address field— Specifies the source operand; use addressing modes listed in the following table:

Addressing Mode	Mode	Register	Addressing Mode	Mode	Register
Dy	000	reg. number:Dy	(xxx).W	—	—
Ay	001	reg. number:Ay	(xxx).L	—	—
(Ay)	—	—	#<data>	111	100
(Ay) +	—	—			
– (Ay)	—	—			
(d ₁₆ ,Ay)	—	—	(d ₁₆ ,PC)	—	—
(d ₈ ,Ay,Xi)	—	—	(d ₈ ,PC,Xi)	—	—

MSAAC

Multiply and Subtract from First Accumulator, Add to Second Accumulator First appeared in EMAC_B

MSAAC

Operation: $ACCx - (Ry * Rx)\{\ll | \gg\} SF \rightarrow ACCx$
 $ACCw + (Ry * Rx)\{\ll | \gg\} SF \rightarrow ACCw$

Assembler syntax: MSAAC.sz Ry,RxSF,ACCx,ACCw

Attributes: Size = word, longword

Description: Multiply two 16 or 32-bit numbers to produce a 40-bit result, then subtract this product, shifted as defined by the scale factor, from an accumulator, ACCx. Add the product, shifted as defined by the scale factor, to another accumulator, ACCw.

Condition Codes (MACSR):

N	Z	V	PAVx	EV
*	*	*	*	*

N Set if the msb of the secondary result is set; cleared otherwise
 Z Set if the secondary result is zero; cleared otherwise
 V Set if a product or secondary accumulation overflow is generated or PAVw=1; cleared otherwise
 PAVx,w Set if any product or accumulation overflow is generated; unchanged otherwise
 EV Set if secondary accumulation overflows lower 32 bits in integer mode or lower 40 bits in fractional mode; cleared otherwise

Instruction Format:

15	14	13	12	11	10	9	8	7	6	5	4	3	2	1	0
1	0	1	0	Register, Rx			0	ACCx lsb	Rx msb	0	0	Register, Ry			
—	—	—	—	sz	Scale Factor		1	U/Lx	U/Ly	—	ACCx msb	ACCw	0	1	

Instruction Fields:

- Register Rx[6,11–9] field— Specifies a source register operand, where 0x0 is D0, ..., 0x7 is D7, 0x8 is A0, ..., 0xF is A7. Note that bit 6 of the operation word is the msb of the register number field.
- ACCx field— Specifies the first destination accumulator, ACCx. Bit 4 of the extension word is the msb and bit 7 of the operation word is the lsb. The value of these two bits specify the accumulator number as shown in the following table:

Extword [4]	Op word [7]	Accumulator
0	0	ACC0
0	1	ACC1
1	0	ACC2
1	1	ACC3

Instruction Fields (continued):

- Register Ry[3–0] field — Specifies a source register operand, where 0x0 is D0,..., 0x7 is D7, 0x8 is A0,..., 0xF is A7.
- sz field—Specifies the size of the input operands
 - 0 word
 - 1 longword
- Scale Factor field—Specifies the scale factor. This field is ignored when using fractional operands.
 - 00 none
 - 01 product $\ll 1$
 - 10 reserved
 - 11 product $\gg 1$
- U/Lx—Specifies which 16-bit operand of the source register, Rx, is used for a word-sized operation.
 - 0 lower word
 - 1 upper word
- U/Ly—Specifies which 16-bit operand of the source register, Ry, is used for a word-sized operation.
 - 0 lower word
 - 1 upper word
- ACCw field—Specifies the second destination accumulator, ACCw. 00 = Accumulator 0; 11 = Accumulator 3.

MSAC

Multiply Subtract

MSAC

Operation: $ACCx - (Ry * Rx)\{\ll | \gg\} SF \rightarrow ACCx$

Assembler syntax: MSAC.sz Ry.{U,L},Rx.{U,L}SF,ACCx

Attributes: Size = word, longword

Description: Multiply two 16- or 32-bit numbers to yield a 40-bit result, then subtract this product, shifted as defined by the scale factor, from an accumulator. If 16-bit operands are used, the upper or lower word of each register must be specified.

Condition Codes (MACSR):

N	Z	V	PAVx	EV
*	*	*	*	*

N Set if the msb of the result is set; cleared otherwise
 Z Set if the result is zero; cleared otherwise
 V Set if a product or accumulation overflow is generated or PAVx=1; cleared otherwise
 PAVx Set if a product or accumulation overflow is generated; unchanged otherwise
 EV Set if accumulation overflows lower 32 bits in integer mode or lower 40 bits in fractional mode; cleared otherwise

Instruction Format:

15	14	13	12	11	10	9	8	7	6	5	4	3	2	1	0	
1	0	1	0	Register, Rx				0	ACC lsb	Rx msb	0	0	Register, Ry			
—	—	—	—	sz	Scale Factor		1	U/Lx	U/Ly	—	ACC msb	—	—	—	—	

Instruction Fields:

- Register Rx[6,11–9] field— Specifies a source register operand, where 0x0 is D0, ..., 0x7 is D7, 0x8 is A0, ..., 0xF is A7. Note that bit 6 of the operation word is the msb of the register number field.
- ACC field— Specifies the destination accumulator, ACCx. Bit 4 of the extension word is the msb and bit 7 of the operation word is the lsb. The value of these two bits specify the accumulator number as shown in the following table.

Extword [4]	Op word [7]	Accumulator
0	0	ACC0
0	1	ACC1
1	0	ACC2
1	1	ACC3

- Register Ry[3–0] field — Specifies a source register operand, where 0x0 is D0, ..., 0x7 is D7, 0x8 is A0, ..., 0xF is A7.

Instruction Fields (continued):

- sz field—Specifies the size of the input operands
 - 0 word
 - 1 longword
- Scale Factor field —Specifies the scale factor. This field is ignored when using fractional operands.
 - 00 none
 - 01 product $\ll 1$
 - 10 reserved
 - 11 product $\gg 1$
- U/Lx—Specifies which 16-bit operand of the source register, Rx, is used for a word-sized operation.
 - 0 lower word
 - 1 upper word
- U/Ly—Specifies which 16-bit operand of the source register, Ry, is used for a word-sized operation.
 - 0 lower word
 - 1 upper word

MSAC

Multiply Subtract with Load

MSAC

Operation: $ACCx - (Ry * Rx)\{\ll | \gg\} SF \rightarrow ACCx$
 $(\langle ea \rangle y) \rightarrow Rw$

Assembler syntax: `MAC.sz Ry.{U,L},Rx.{U,L}SF,<ea>y&,Rw,ACCx`
 where & enables the use of the MASK

Attributes: Size = word, longword

Description: Multiply two 16- or 32-bit numbers to yield a 40-bit result, then subtract this product, shifted as defined by the scale factor, from an accumulator. If 16-bit operands are used, the upper or lower word of each register must be specified. In parallel with this operation, a 32-bit operand is fetched from the memory location defined by <ea>y and loaded into the destination register, Rw. If the MASK register is specified to be used, the <ea>y operand is ANDed with MASK prior to being used by the instruction.

Condition Codes (MACSR):	N	Z	V	PAVx	EV	N	Set if the msb of the result is set; cleared otherwise
	*	*	*	*	*	Z	Set if the result is zero; cleared otherwise
						V	Set if a product or accumulation overflow is generated or PAVx=1; cleared otherwise
						PAVx	Set if a product or accumulation overflow is generated; unchanged otherwise
						EV	Set if accumulation overflows lower 32 bits (integer) or lower 40 bits (fractional); cleared otherwise

Instruction Format:

15	14	13	12	11	10	9	8	7	6	5	4	3	2	1	0	
1	0	1	0	Register, Rw				0	ACC lsb	Rw msb	Source Effective Address					
				Mode		Register										
Register, Rx				sz	Scale Factor		1	U/Lx	U/Ly	Mask	ACC msb	Register, Ry				

Instruction Fields:

- Register Rw[6,11–9] field— Specifies the destination register, Rw, where 0x0 is D0,..., 0x7 is D7, 0x8 is A0,..., 0xF is A7. Note that bit 6 of the operation word is the msb of the register number field.
- ACC field—Specifies the destination accumulator, ACCx. Bit 4 of the extension word is the msb and bit 7 of the operation word is the inverse of the lsb (unlike the MSAC without load). The value of these two bits specify the accumulator number as shown in the following table:

Ext word [4]	Op word [7]	Accumulator
0	1	ACC0
0	0	ACC1
1	1	ACC2
1	0	ACC3

Instruction Fields (continued):

- Source Effective Address field specifies the source operand, <ea>y; use addressing modes in the following table:

Addressing Mode	Mode	Register	Addressing Mode	Mode	Register
Dy	—	—	(xxx).W	—	—
Ay	—	—	(xxx).L	—	—
(Ay)	010	reg. number: Ay	#<data>	—	—
(Ay) +	011	reg. number: Ay			
– (Ay)	100	reg. number: Ay			
(d ₁₆ , Ay)	101	reg. number: Ay	(d ₁₆ , PC)	—	—
(d ₈ , Ay, Xi)	—	—	(d ₈ , PC, Xi)	—	—

- Register Rx field — Specifies a source register operand, where 0x0 is D0, ..., 0x7 is D7, 0x8 is A0, ..., 0xF is A7.
- sz field—Specifies the size of the input operands
 - 0 word
 - 1 longword
- Scale Factor field — Specifies the scale factor. This field is ignored when using fractional operands.
 - 00 none
 - 01 product << 1
 - 10 reserved
 - 11 product >> 1
- U/Lx, U/Ly—Specifies which 16-bit operand of the source register, Rx/Ry, is used for a word-sized operation.
 - 0 lower word
 - 1 upper word
- Mask field — Specifies whether or not to use the MASK register in generating the source effective address, <ea>y.
 - 0 do not use MASK
 - 1 use MASK
- Register Ry field — Specifies a source register operand, where 0x0 is D0, ..., 0x7 is D7, 0x8 is A0, ..., 0xF is A7.

MSSAC

Multiply and Subtract from First Accumulator, Subtract from Second Accumulator

First appeared in EMAC_B

MSSAC

Operation: $ACCx - (Ry * Rx)\{\ll | \gg\} SF \rightarrow ACCx$
 $ACCw - (Ry * Rx)\{\ll | \gg\} SF \rightarrow ACCw$

Assembler syntax: MSSAC.sz Ry,RxSF,ACCx,ACCw

Attributes: Size = word, longword

Description: Multiply two 16 or 32-bit numbers to produce a 40-bit result, then subtract this product, shifted as defined by the scale factor, from an accumulator, ACCx, and also subtract it from another accumulator, ACCw.

Condition Codes (MACSR):

N	Z	V	PAVx	EV
*	*	*	*	*

N Set if the msb of the secondary result is set; cleared otherwise
Z Set if the secondary result is zero; cleared otherwise
V Set if a product or secondary accumulation overflow is generated or PAVw=1; cleared otherwise
PAVx,w Set if any product or accumulation overflow is generated; unchanged otherwise
EV Set if secondary accumulation overflows lower 32 bits in integer mode or lower 40 bits in fractional mode; cleared otherwise

Instruction Format:

15	14	13	12	11	10	9	8	7	6	5	4	3	2	1	0
1	0	1	0	Register, Rx			0	ACCx lsb	Rx msb	0	0	Register, Ry			
—	—	—	—	sz	Scale Factor		1	U/Lx	U/Ly	—	ACCx msb	ACCw	1	1	

Instruction Fields:

- Register Rx[6,11–9] field— Specifies a source register operand, where 0x0 is D0, ..., 0x7 is D7, 0x8 is A0, ..., 0xF is A7. Note that bit 6 of the operation word is the msb of the register number field.
- ACCx field— Specifies the first destination accumulator, ACCx. Bit 4 of the extension word is the msb and bit 7 of the operation word is the lsb. The value of these two bits specify the accumulator number as shown in the following table:

Extword [4]	Op word [7]	Accumulator
0	0	ACC0
0	1	ACC1
1	0	ACC2
1	1	ACC3

Instruction Fields (continued):

- Register Ry[3–0] field — Specifies a source register operand, where 0x0 is D0,..., 0x7 is D7, 0x8 is A0,..., 0xF is A7.
- sz field—Specifies the size of the input operands
 - 0 word
 - 1 longword
- Scale Factor field—Specifies the scale factor. This field is ignored when using fractional operands.
 - 00 none
 - 01 product $\ll 1$
 - 10 reserved
 - 11 product $\gg 1$
- U/Lx—Specifies which 16-bit operand of the source register, Rx, is used for a word-sized operation.
 - 0 lower word
 - 1 upper word
- U/Ly—Specifies which 16-bit operand of the source register, Ry, is used for a word-sized operation.
 - 0 lower word
 - 1 upper word
- ACCw field—Specifies the second destination accumulator, ACCw. 00 = Accumulator 0; 11 = Accumulator 3.

Chapter 7

Floating-Point Unit (FPU)

User Instructions

This chapter contains the instruction descriptions implemented in the optional floating-point unit (FPU). Common information on the effects on the floating-point status register (FPSR) and conditional testing has been consolidated in the front of the chapter.

7.1 Floating-Point Status Register (FPSR)

The FPSR, [Figure 7-1](#), contains a floating-point condition code byte (FPCC), a floating-point exception status byte (EXC), and a floating-point accrued exception byte (AEXC). The user can read or write all FPSR bits. Execution of most floating-point instructions modifies FPSR.

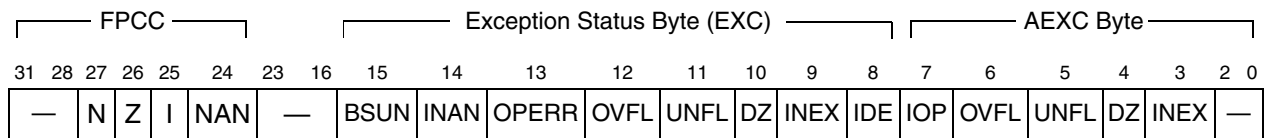

Figure 7-1. Floating-Point Status Register (FPSR)

[Table 7-1](#) describes FPSR fields.

Table 7-1. FPSR Field Descriptions

Bits	Field	Description
31–24	FPCC	Floating-point condition code byte. Contains four condition code bits that are set after completion of all arithmetic instructions involving the floating-point data registers. The floating-point store operation, FMOVEM, and move system control register instructions do not affect the FPCC.
31–28		Reserved, should be cleared.
27	N	Negative
26	Z	Zero
25	I	Infinity
24	NAN	Not-a-number
23–16	—	Reserved, should be cleared.

Table 7-1. FPSR Field Descriptions (Continued)

Bits	Field	Description	
15–8	EXC	Exception status byte. Contains a bit for each floating-point exception that might have occurred during the most recent arithmetic instruction or move operation.	
15		BSUN	Branch/set on unordered
14		INAN	Input not-a-number
13		OPERR	Operand error
12		OVFL	Overflow
11		UNFL	Underflow
10		DZ	Divide by zero
9		INEX	Inexact result
8		IDE	Input is denormalized
7–0	AEXC	Accrued exception byte. At the end of arithmetic operations, EXC bits are logically combined to form an AEXC value that is logically ORed into the existing AEXC byte (FBcc only updates IOP). This operation creates sticky floating-point exception bits in AEXC that the user can poll only at the end of a series of floating-point operations. A sticky bit is one that remains set until the user clears it.	
7		IOP	Invalid operation
6		OVFL	Overflow
5		UNFL	Underflow
4		DZ	Divide by zero
3		INEX	Inexact result
2–0		—	Reserved, should be cleared.

For AEXC[OVFL], AEXC[DZ], and AEXC[INEX], the next value is determined by ORing the current AEXC value with the EXC equivalent, as shown in the following:

- Next AEXC[OVFL] = Current AEXC[OVFL] | EXC[OVFL]
- Next AEXC[DZ] = Current AEXC[DZ] | EXC[DZ]
- Next AEXC[INEX] = Current AEXC[INEX] | EXC[INEX]

For AEXC[IOP] and AEXC[UNFL], the next value is calculated by ORing the current AEXC value with EXC bit combinations, as follows:

- Next AEXC[IOP] = Current AEXC[IOP] | EXC[BSUN | INAN | OPERR]
- Next AEXC[UNFL] = Current AEXC[UNFL] | EXC[UNFL & INEX]

Table 7-2 shows how the FPSR EXC bits are affected by instruction execution.

Table 7-2. FPSR EXC Bits

EXC Bit	Description
BSUN	Branch/set on unordered. Set on FBcc if the NAN bit is set and the condition selected is an IEEE nonaware test; cleared otherwise.
INAN	Input not-a-number. Set if either input operand is a NAN; cleared otherwise.
IDE	Input denormalized number. Set if either input operand is a denormalized number; cleared otherwise.
OPERR	Operand error. Set under the following conditions: FADD[(+∞) + (-∞)] or [(-∞) + (+∞)] FDIV(0 ÷ 0) or (∞ ÷ ∞) FMOVE OUT (to B,W,L)Integer overflow, source is NAN or ±∞ FMULSource is < 0 or -∞ FSQROne operand is 0 and the other is ±∞ FSUB[(+∞) - (+∞)] or [(-∞) - (-∞)] Cleared otherwise.
OVFL	Overflow. Set during arithmetic operations if the destination is a floating-point data register or memory when the intermediate result's exponent is greater than or equal to the maximum exponent value of the selected rounding precision. Cleared otherwise. Overflow occurs only when the destination is S- or D-precision format; overflows for other formats are handled as operand errors.
UNFL	Underflow. Set if the intermediate result of an arithmetic instruction is too small to be represented as a normalized number in a floating-point register or memory using the selected rounding precision, that is, when the intermediate result exponent is less than or equal to the minimum exponent value of the selected rounding precision. Cleared otherwise. Underflow can only occur when the destination format is single or double precision. When the destination is byte, word, or longword, the conversion underflows to zero without causing an underflow or an operand error.
DZ	Set if a FDIV instruction is attempted with a zero divisor; cleared otherwise.
INEX	Set under the following conditions: <ul style="list-style-type: none"> • If the infinitely-precise mantissa of a floating-point intermediate result has more significant bits than can be represented exactly in the selected rounding precision or in the destination format • If an input operand is a denormalized number and the input denorm exception (IDE) is disabled • An overflowed result • An underflowed result with the underflow exception disabled Cleared otherwise.

7.2 Conditional Testing

Unlike operation-dependent integer condition codes, an instruction either always sets FPCC bits in the same way or does not change them at all. Therefore, instruction descriptions do not include FPCC settings. This section describes how FPCC bits are set.

FPCC bits differ slightly from integer condition codes. An FPU operation's final result sets or clears FPCC bits accordingly, independent of the operation itself. Integer condition codes bits CCR[N] and CCR[Z] have this characteristic, but CCR[V] and CCR[C] are set differently for different instructions. [Table 7-3](#) lists FPCC settings for each data type. Loading FPCC with another combination and executing a conditional instruction can produce an unexpected branch condition.

Table 7-3. FPCC Encodings

Data Type	N	Z	I	NAN
+ Normalized or Denormalized	0	0	0	0
– Normalized or Denormalized	1	0	0	0
+ 0	0	1	0	0
– 0	1	1	0	0
+ Infinity	0	0	1	0
– Infinity	1	0	1	0
+ NAN	0	0	0	1
– NAN	1	0	0	1

The inclusion of the NAN data type in the IEEE floating-point number system requires each conditional test to include FPCC[NAN] in its boolean equation. Because it cannot be determined whether a NAN is bigger or smaller than an in-range number (that is, it is unordered), the compare instruction sets FPCC[NAN] when an unordered compare is attempted. All arithmetic instructions that result in a NAN also set the NAN bit. Conditional instructions interpret NAN being set as the unordered condition.

The IEEE-754 standard defines the following four conditions:

- Equal to (EQ)
- Greater than (GT)
- Less than (LT)
- Unordered (UN)

The standard requires only the generation of the condition codes as a result of a floating-point compare operation. The FPU can test for these conditions and 28 others at the end of any operation affecting condition codes. For floating-point conditional branch instructions, the processor logically combines the 4 bits of the FPCC condition codes to form 32 conditional tests, 16 of which cause an exception if an unordered condition is present when the conditional test is attempted (IEEE nonaware tests). The other 16 do not cause an exception (IEEE-aware tests). The set of IEEE nonaware tests is best used in one of the following cases:

- When porting a program from a system that does not support the IEEE standard to a conforming system
- When generating high-level language code that does not support IEEE floating-point concepts (that is, the unordered condition).

An unordered condition occurs when one or both of the operands in a floating-point compare operation is a NAN. The inclusion of the unordered condition in floating-point branches destroys the familiar trichotomy relationship (greater than, equal, less than) that exists for integers. For example, the opposite of floating-point branch greater than (FBGT) is not floating-point branch less than or equal (FBLE). Rather, the opposite condition is floating-point branch not greater than (FBNGT). If the result of the previous instruction was unordered, FBNGT is true; whereas, both FBGT and FBLE would be false because unordered fails both of these tests (and sets BSUN). Because it is common for compilers to invert the sense of conditions, compiler code generators should be particularly careful of the lack of trichotomy in the floating-point branches.

When using the IEEE nonaware tests, the user receives a BSUN exception if a branch is attempted and FPCC[NAN] is set, unless the branch is an FBEG or an FBNE. If the BSUN exception is enabled in FPCR, the exception takes a BSUN trap. Therefore, the IEEE nonaware program is interrupted if an unexpected

condition occurs. Users knowledgeable of the IEEE-754 standard should use IEEE-aware tests in programs that contain ordered and unordered conditions. Because the ordered or unordered attribute is explicitly included in the conditional test, EXC[BSUN] is not set when the unordered condition occurs. Table 7-4 summarizes conditional mnemonics, definitions, equations, predicates, and whether EXC[BSUN] is set for the 32 floating-point conditional tests. The equation column lists FPCC bit combinations for each test in the form of an equation. Condition codes with an overbar indicate cleared bits; all other bits are set.

Table 7-4. Floating-Point Conditional Tests

Mnemonic	Definition	Equation	Predicate ¹	EXC[BSUN] Set
IEEE Nonaware Tests				
EQ	Equal	Z	000001	No
NE	Not equal	\bar{Z}	001110	No
GT	Greater than	$\overline{NAN \mid Z \mid \bar{N}}$	010010	Yes
NGT	Not greater than	$NAN \mid Z \mid N$	011101	Yes
GE	Greater than or equal	$Z \mid \overline{(NAN \mid \bar{N})}$	010011	Yes
NGE	Not greater than or equal	$NAN \mid (N \ \& \ \bar{Z})$	011100	Yes
LT	Less than	$N \ \& \ \overline{(NAN \mid \bar{Z})}$	010100	Yes
NLT	Not less than	$NAN \mid (Z \mid \bar{N})$	011011	Yes
LE	Less than or equal	$Z \mid (N \ \& \ \overline{NAN})$	010101	Yes
NLE	Not less than or equal	$NAN \mid (\bar{N} \mid \bar{Z})$	011010	Yes
GL	Greater or less than	$\overline{NAN \mid \bar{Z}}$	010110	Yes
NGL	Not greater or less than	$NAN \mid Z$	011001	Yes
GLE	Greater, less or equal	\overline{NAN}	010111	Yes
NGLE	Not greater, less or equal	NAN	011000	Yes
IEEE-Aware Tests				
EQ	Equal	Z	000001	No
NE	Not equal	\bar{Z}	001110	No
OGT	Ordered greater than	$\overline{NAN \mid Z \mid \bar{N}}$	000010	No
ULE	Unordered or less or equal	$NAN \mid Z \mid N$	001101	No
OGE	Ordered greater than or equal	$Z \mid \overline{(NAN \mid \bar{N})}$	000011	No
ULT	Unordered or less than	$NAN \mid (N \ \& \ \bar{Z})$	001100	No
OLT	Ordered less than	$N \ \& \ \overline{(NAN \mid \bar{Z})}$	000100	No
UGE	Unordered or greater or equal	$NAN \mid (Z \mid \bar{N})$	001011	No
OLE	Ordered less than or equal	$Z \mid (N \ \& \ \overline{NAN})$	000101	No
UGT	Unordered or greater than	$NAN \mid (\bar{N} \mid \bar{Z})$	001010	No
OGL	Ordered greater or less than	$\overline{NAN \mid \bar{Z}}$	000110	No

Table 7-4. Floating-Point Conditional Tests (Continued)

Mnemonic	Definition	Equation	Predicate ¹	EXC[BSUN] Set
UEQ	Unordered or equal	$\text{NAN} \mid Z$	001001	No
OR	Ordered	$\overline{\text{NAN}}$	000111	No
UN	Unordered	NAN	001000	No
Miscellaneous Tests				
F	False	False	000000	No
T	True	True	001111	No
SF	Signaling false	False	010000	Yes
ST	Signaling true	True	011111	Yes
SEQ	Signaling equal	Z	010001	Yes
SNE	Signaling not equal	\overline{Z}	011110	Yes

¹ This column refers to the value in the instruction's conditional predicate field that specifies this test.

7.3 Instruction Results when Exceptions Occur

Instruction execution results may be different depending on whether exceptions are enabled in the FPCR, as shown in [Table 7-5](#). An exception is enabled when the value of the EXC bit is 1, disabled when the value is 0. Note that if an exception is enabled and occurs on a FMOVE OUT, the destination is unaffected.

Table 7-5. FPCR EXC Byte Exception Enabled/Disabled Results

EXC Bit	Exception	Description
BSUN	Disabled	The floating-point condition is evaluated as if it were the equivalent IEEE-aware conditional predicate. No exceptions are taken.
	Enabled	The processor takes a floating-point pre-instruction exception.
INAN	Disabled	If the destination data format is single- or double-precision, a NAN is generated with a mantissa of all ones and a sign of zero transferred to the destination. If the destination data format is B, W, or L, a constant of all ones is written to the destination.
	Enabled	The result written to the destination is the same as the exception disabled case unless the exception occurs on a FMOVE OUT, in which case the destination is unaffected.
IDE	Disabled	The operand is treated as zero, INEX is set, and processing continues.
	Enabled	If an operand is denormalized, an IDE exception is taken but INEX is not set so that the handler can set INEX appropriately. The destination is overwritten with the same value as if IDE were disabled unless the exception occurred on a FMOVE OUT, in which case the destination is unaffected.

Table 7-5. FPCR EXC Byte Exception Enabled/Disabled Results (Continued)

EXC Bit	Exception	Description
OPERR	Disabled	When the destination is a floating-point data register, the result is a double-precision NAN, with its mantissa set to all ones and the sign set to zero (positive). For a FMOVE OUT instruction with the format S or D, an OPERR is impossible. With the format B, W, or L, an OPERR is possible only on a conversion to integer overflow, or if the source is either an infinity or a NAN. On integer overflow and infinity source cases, the largest positive or negative integer that can fit in the specified destination format (B, W, or L) is stored. In the NAN source case, a constant of all ones is written to the destination.
	Enabled	The result written to the destination is the same as for the exception disabled case unless the exception occurred on a FMOVE OUT, in which case the destination is unaffected.
OVFL	Disabled	The values stored in the destination based on the rounding mode defined in FPCR[MODE]. RN Infinity, with the sign of the intermediate result. RZ Largest magnitude number, with the sign of the intermediate result. RM For positive overflow, largest positive normalized number For negative overflow, $-\infty$. RP For positive overflow, $+\infty$ For negative overflow, largest negative normalized number.
	Enabled	The result written to the destination is the same as for the exception disabled case unless the exception occurred on a FMOVE OUT, in which case the destination is unaffected.
UNFL	Disabled	The stored result is defined below. UNFL also sets INEX if the UNFL exception is disabled. RN Zero, with the sign of the intermediate result. RZ Zero, with the sign of the intermediate result. RM For positive underflow, + 0 For negative underflow, smallest negative normalized number. RP For positive underflow, smallest positive normalized number For negative underflow, - 0
	Enabled	The result written to the destination is the same as for the exception disabled case unless the exception occurs on a FMOVE OUT, in which case the destination is unaffected.
DZ	Disabled	The destination floating-point data register is written with infinity with the sign set to the exclusive OR of the signs of the input operands.
	Enabled	The destination floating-point data register is written as in the exception is disabled case.
INEX	Disabled	The result is rounded and then written to the destination.
	Enabled	The result written to the destination is the same as for the exception disabled case unless the exception occurred on a FMOVE OUT, in which case the destination is unaffected.

7.4 Key Differences between ColdFire and MC680x0 FPU Programming Models

This section is intended for compiler developers and developers porting assembly language routines from 68K to ColdFire. It highlights major differences between the ColdFire FPU instruction set architecture (ISA) and the equivalent 68K family ISA, using the MC68060 as the reference. The internal FPU datapath width is the most obvious difference. ColdFire uses 64-bit double-precision and the 68K Family uses 80-bit extended precision. Other differences pertain to supported addressing modes, both across all FPU instructions as well as specific opcodes. [Table 7-6](#) lists key differences. Because all ColdFire implementations support instruction sizes of 48 bits or less, 68K operations requiring larger instruction lengths cannot be supported.

Table 7-6. Key Programming Model Differences

Feature	68K	ColdFire
Internal datapath width	80 bits	64 bits
Support for fpGEN $d_8(A_n, X_i), FP_x$	Yes	No
Support for fpGEN $xxx.\{w,l\}, FP_x$	Yes	No
Support for fpGEN $d_8(PC, X_i), FP_x$	Yes	No
Support for fpGEN $\#xxx, FP_x$	Yes	No
Support for fmovem (Ay)+, #list	Yes	No
Support for fmovem #list, -(Ax)	Yes	No
Support for fmovem FP Control Registers	Yes	No

Some differences affect function activation and return. 68K subroutines typically began with FMOVEM #list, -(a7) to save registers on the system stack, with each register occupying 3 longwords. In ColdFire, each register occupies 2 longwords and the stack pointer must be adjusted before the FMOVEM instruction. A similar sequence generally occurs at the end of the function, preparing to return control to the calling routine.

The examples in [Table 7-7](#), [Table 7-8](#), and [Table 7-9](#) show a 68K operation and the equivalent ColdFire sequence.

Table 7-7. 68K/ColdFire Operation Sequence 1¹

68K	ColdFire Equivalent
fmovem.x #list, -(a7)	lea -8*n(a7), a7; allocate stack space fmovem.d #list, (a7) ; save FPU registers
fmovem.x (a7)+, #list	fmovem.d (a7), #list ; restore FPU registers lea 8*n(a7), a7 ; deallocate stack space

¹ n is the number of FP registers to be saved/restored.

If the subroutine includes LINK and UNLK instructions, the stack space needed for FPU register storage can be factored into these operations and LEA instructions are not required.

The 68K FPU supports loads and stores of multiple control registers (FPCR, FPSR, and FPIAR) with one instruction. For ColdFire, only one can be moved at a time.

For instructions that require an unsupported addressing mode, the operand address can be formed with a LEA instruction immediately before the FPU operation. See [Table 7-8](#).

Table 7-8. 68K/ColdFire Operation Sequence 2

68K	ColdFire Equivalent
fadd.s label, fp2	lea label, a0; form pointer to data fadd.s (a0), fp2
fmul.d (d8, a1, d7), fp5	lea (d8, a1, d7), a0; form pointer to data fmul.d (a0), fp5
fcmp.l (d8, pc, d2), fp3	lea (d8, pc, d2), a0; form pointer to data fcmp.l (a0), fp3

The 68K FPU allows floating-point instructions to directly specify immediate values; the ColdFire FPU does not support these types of immediate constants. It is recommended that floating-point immediate values be moved into a table of constants that can be referenced using PC-relative addressing or as an offset from another address pointer. See [Table 7-9](#). Note for ColdFire that if a PC-relative effective address is specified for an FPU instruction, the PC always holds the address of the 16-bit operation word plus 2.

Table 7-9. 68K/ColdFire Operation Sequence 3

68K	ColdFire Equivalent
fadd.l #imm1,fp3	fadd.l (imm1_label,pc),fp3
fsub.s #imm2,fp4	fsub.s (imm2_label,pc),fp3
fdiv.d #imm3,fp5	fdiv.d (imm3_label,pc),fp3 align 4 imm1_label: long imm1 ;integer longword imm2_label: long imm2 ;single-precision align 8 imm3_label: long imm3_upper, imm3_lower ;double-precision

Finally, ColdFire and the 68K differ in how exceptions are made pending. In the ColdFire exception model, asserting both an FPSR exception indicator bit and the corresponding FPCR enable bit makes an exception pending. Thus, a pending exception state can be created by loading FPSR and/or FPCR. On the 68K, this type of pending exception is not possible.

Analysis of compiled floating-point applications indicates these differences account for most of the changes between 68K-compatible text and the equivalent ColdFire program.

7.5 Instruction Descriptions

This section describes floating-point instructions in alphabetical order by mnemonic. Operation tables list results for each situation that can be encountered in each instruction. The top and left side of each table represent possible operand inputs, both positive and negative; results are shown in other entries. In most cases, results are floating-point values (numbers, infinities, zeros, or NaNs), but for FCMP and FTST, the only result is the setting of condition code bits. When none is stated, no condition code bits are set. Note that if a PC-relative effective address is specified for an FPU instruction, the PC always holds the address of the 16-bit operation word plus 2.

To understand the results of floating-point instructions under exceptional conditions (overflow, NAN operand, etc.), refer to [Table 7-5](#).

[Table 7-10](#) shows data format encoding used for source data and for destination data for FMOVE register-to-memory operations.

Table 7-10. Data Format Encoding

Source Data Format	Description
000	Longword integer (L)
001	Single-precision real (S)
100	Word integer (W)
101	Double-precision real (D)
110	Byte integer (B)

FABS

Floating-Point Absolute Value

FABS

Operation: Absolute value of source → FPx

Assembler Syntax: FABS.fmt <ea>y,FPx
 FABS.D FPy,FPx
 FABS.D FPx
 FrABS.fmt <ea>y,FPx
 FrABS.D FPy,FPx
 FrABS.D FPx

where r is rounding precision, S or D

Attributes: Format = byte, word, longword, single-precision, double-precision

Description: Converts the source operand to double-precision (if necessary) and stores its absolute value in the destination floating-point data register.

FABS rounds the result to the precision selected in FPCR. FSABS and FDABS round to single- or double-precision, respectively, regardless of the rounding precision selected in FPCR.

Operation Table:

Destination	Source ¹							
	+	In Range	-	+	Zero	-	+	Infinity
Result	Absolute Value		Absolute Value		Absolute Value			

¹ If the source operand is a NAN, refer to [Section 1.7.1.4, “Not-A-Number.”](#)

FPSR[FPCC]: See [Section 7.2, “Conditional Testing.”](#)

FPSR [EXC]:	BSUN	INAN	IDE	OPERR	OVFL	UNFL	DZ	INEX
	0	See Table 7-2		0	0	0	0	0

FPSR[AEXC]: See [Section 7.1, “Floating-Point Status Register \(FPSR\)”](#)

Instruction Format:

15	14	13	12	11	10	9	8	7	6	5	4	3	2	1	0
1	1	1	1	0	0	1	0	0	0	Source Effective Address					
										Mode		Register			
0	R/M	0	Source Specifier			Destination Register, FPx		Opmode							

Instruction fields:

- Source Effective Address field—Determines the addressing mode for external operands.
 - If R/M = 1, this field specifies the location of the source operand, <ea>y. Only the addressing modes listed in the following table can be used.

Addressing Mode	Mode	Register	Addressing Mode	Mode	Register
Dy ¹	000	reg. number:Dy	(xxx).W	—	—
Ay	—	—	(xxx).L	—	—
(Ay)	010	reg. number: Ay	# <data>	—	—
(Ay)+	011	reg. number: Ay			
-(Ay)	100	reg. number: Ay			
(d ₁₆ ,Ay)	101	reg. number: Ay	(d ₁₆ ,PC)	111	010
(d ₈ ,Ay,Xi)	—	—	(d ₈ ,PC,Xi)	—	—

¹ Only if format is byte, word, longword or single-precision.

- If R/M = 0, this field is unused and must be all zeros.
- R/M field—Specifies the source operand address mode.
 - 1: The operation is <ea>y to register.
 - 0: The operation is register to register.
- Source Specifier field—Specifies the source register or data format.
 - If R/M = 1, specifies the source data format. [Table 7-10](#) shows source data format encoding.
 - If R/M = 0, specifies the source floating-point data register, FPy.
- Destination Register field—Specifies the destination floating-point data register, FPx.
- Opmode field—Specifies the instruction and rounding precision.

Opmode	Instruction	Rounding Precision
0011000	FABS	Rounding precision specified by FPCR
1011000	FSABS	Single-precision rounding
1011100	FDABS	Double-precision rounding

FADD

Floating-Point Add

FADD

Operation: Source + FP_x → FP_x

Assembler Syntax: FADD.fmt <ea>y,FP_x
 FADD.D FP_y,FP_x
 FrADD.fmt <ea>y,FP_x
 FrADD.D FP_y,FP_x
 where r is rounding precision, S or D

Attributes: Format = byte, word, longword, single-precision, double-precision

Description: Converts the source operand to double-precision (if necessary) and adds that number to the number in the destination floating-point data register. Stores the result in the destination floating-point data register.

FADD rounds the result to the precision selected in FPCR. FSADD and FDADD round the result to single- or double-precision, respectively, regardless of the rounding precision selected in FPCR.

Operation Table:

Destination	Source ¹									
	+	In Range	-	+	Zero	-	+	Infinity	-	
In Range	+	Add	-	+	Add	-	+	+inf	-	-inf
Zero	+	Add	-	+	+0.0 0.0 ²	-	+	0.0 ² -0.0	-	+inf -inf
Infinity	+	+inf -inf	-	+	+inf -inf	-	+	+inf NAN ³	-	NAN ³ -inf

¹ If the source operand is a NAN, refer to [Section 1.7.1.4, “Not-A-Number.”](#)

² Returns +0.0 in rounding modes RN, RZ, and RP; returns -0.0 in RM.

³ Sets the OPERR bit in the FPSR exception byte.

FPSR[FPCC]: See [Section 7.2, “Conditional Testing.”](#)

FPSR [EXC]:	BSUN	INAN	IDE	OPERR	OVFL	UNFL	DZ	INEX
0		See Table 7-2		Set if source and destination are opposite-signed infinities; cleared otherwise.		See Table 7-2	0	See Table 7-2

FPSR[AEXC]: See [Section 7.1, “Floating-Point Status Register \(FPSR\)”](#)

FADD

Floating-Point Add

FADD

Instruction Format:

15	14	13	12	11	10	9	8	7	6	5	4	3	2	1	0
1	1	1	1	0	0	1	0	0	0	Source Effective Address					
										Mode		Register			
0	R/M	0	Source Specifier			Destination Register, FPx		Opmode							

Instruction fields:

- Source Effective Address field—Determines the addressing mode.
 - If R/M = 1, this field specifies the location of the source operand, <ea>y. Only the addressing modes listed in the following table can be used.

Addressing Mode	Mode	Register	Addressing Mode	Mode	Register
Dy ¹	000	reg. number:Dy	(xxx).W	—	—
Ay	—	—	(xxx).L	—	—
(Ay)	010	reg. number: Ay	# <data>	—	—
(Ay)+	011	reg. number: Ay			
-(Ay)	100	reg. number: Ay			
(d ₁₆ ,Ay)	101	reg. number: Ay	(d ₁₆ ,PC)	111	010
(d ₈ ,Ay,Xi)	—	—	(d ₈ ,PC,Xi)	—	—

¹ Only if format is byte, word, longword or single-precision.

- If R/M = 0, this field is unused and must be all zeros.
- R/M field—Specifies the source operand address mode.
 - 1: The operation is <ea>y to register.
 - 0: The operation is register to register.
- Source Specifier field—Specifies the source register or data format.
 - If R/M = 1, specifies the source data format. See [Table 7-10](#).
 - If R/M = 0, specifies the source floating-point data register, FPy.
- Destination Register field—Specifies the destination floating-point register, FPx.
- Opmode field—Specifies the instruction and rounding precision.

Opmode	Instruction	Rounding Precision
0100010	FADD	Rounding precision specified by FPCR
1100010	FSADD	Single-precision rounding
1100110	FDADD	Double-precision rounding

FBcc Floating-Point Branch Conditionally FBcc

Operation: If Condition True
Then $PC + d_n \rightarrow PC$

Assembler Syntax: FBcc.fmt <label>

Attributes: Format = word, longword

Description: If the specified condition is met, execution continues at (PC) + displacement, a 2's-complement integer that counts relative distance in bytes. The PC value determining the destination is the branch address plus 2. For word displacement, a 16-bit value is stored in the word after the instruction operation word. For longword displacement, a 32-bit value is stored in the longword after the instruction operation word. The specifier cc selects a test described in [Section 7.2, "Conditional Testing."](#)

FPSR[FPCC]: Not affected.

FPSR [EXC]:	BSUN	INAN	IDE	OPERR	OVFL	UNFL	DZ	INEX
Set if the NAN bit is set and the condition selected is an IEEE nonaware test.	Not affected							

FPSR [AEXC]:	IOP	OVFL	UNFL	DZ	INEX
Set if EXC[BSUN] is set.	Not affected				

Instruction Format:	15	14	13	12	11	10	9	8	7	6	5	4	3	2	1	0
		1	1	1	1	0	0	1	0	1	Size	Conditional Predicate				
16-Bit Displacement or Most Significant Word of 32-bit Displacement																
Least Significant Word of 32-bit Displacement (if needed)																

Instruction fields:

- Size field—Specifies the size of the signed displacement.
 - If size = 1, displacement is 32 bits.
 - If size = 0, displacement is 16 bits and is sign-extended before use.
- Conditional predicate field—Specifies a conditional test defined in [Table 7-4](#).

NOTE

A BSUN exception causes a pre-instruction exception to be taken. If the handler does not update the stack frame PC image to point to the instruction after FBcc, it must clear the NAN bit or disable the BSUN trap, or the exception recurs on returning.

FCMP

Floating-Point Compare

FCMP

Operation: FPx – Source

Assembler Syntax: FCMP.fmt <ea>y,FPx
FCMP.D FPy,FPx

Attributes: Format = byte, word, longword, single-precision, double-precision

Description: Converts the source operand to double-precision (if necessary) and subtracts the operand from the destination floating-point data register. The result of the subtraction is not retained but is used to set floating-point condition codes as described in [Section 7.2, “Conditional Testing.”](#)

Note that if either operand is denormalized, it is treated as zero. Thus, two denormalized operands will compare as equal (set FPCC[Z]) even if they are not identical. This situation can be detected with INEX or IDE.

The entries in this table differ from those for most floating-point instructions. For each combination of input operand types, condition code bits that may be set are indicated. If a condition code bit name is given and is not enclosed in brackets, it is always set. If the name is enclosed in brackets, the bit is set or cleared, as appropriate. If the name is not given, the operation always clears the bit. FCMP always clears the infinity bit because it is not used by any conditional predicate equations.

Operation Table:	Destination	Source ¹					
		+ In Range -		+ Zero -		+ Infinity -	
In Range	+ {NZ} - N	none {NZ}	none N	none N	none N	N N	none none
Zero	+ N - N	none none	Z NZ	Z NZ	N N	none none	
Infinity	+ none - N	none N	none N	none N	none N	Z N	none NZ

¹ If the source operand is a NAN, refer to [Section 1.7.1.4, “Not-A-Number.”](#)

NOTE

The NAN bit is not shown because NANs are always handled in the same manner (see [Section 1.7.1.4, “Not-A-Number.”](#))

FPSR[FPCC]: See preceding operation table.

FPSR [EXC]:	BSUN	INAN	IDE	OPERR	OVFL	UNFL	DZ	INEX
0	0	See Table 7-2	0	0	0	0	0	Set if either operand is denormalized and the operands are not exactly the same and IDE is disabled, cleared otherwise.

FCMP

Floating-Point Compare

FCMP

FPSR[AEXC]: See [Section 7.1, “Floating-Point Status Register \(FPSR\)”](#)

Instruction Format:		15	14	13	12	11	10	9	8	7	6	5	4	3	2	1	0
1	1	1	1	0	0	1	0	0	0	Source Effective Address							
										Mode			Register				
0	R/M	0	Source Specifier			Destination Register, FPx			0	1	1	1	0	0	0		

Instruction fields:

- Effective Address field—Specifies the addressing mode for external operands. If R/M = 1, this field specifies the location of the source operand, <ea>y. Only the addressing modes listed in the following table can be used:

Addressing Mode	Mode	Register	Addressing Mode	Mode	Register
Dy ¹	000	reg. number:Dy	(xxx).W	—	—
Ay	—	—	(xxx).L	—	—
(Ay)	010	reg. number:Ay	# <data>	—	—
(Ay)+	011	reg. number:Ay			
-(Ay)	100	reg. number:Ay			
(d ₁₆ ,Ay)	101	reg. number:Ay	(d ₁₆ ,PC)	111	010
(d ₈ ,Ay,Xi)	—	—	(d ₈ ,PC,Xi)	—	—

¹ Only if format is byte, word, longword or single-precision.

If R/M = 0, this field is unused and must be all zeros.

- R/M field—Specifies the source operand address mode.
 - 1: The operation is <ea>y to register.
 - 0: The operation is register to register.
- Source specifier field—Specifies the source register or data format. If R/M = 1, specifies the source data format. See [Table 7-10](#). If R/M = 0, specifies the source floating-point data register, FPy.
- Destination register field—Specifies the destination floating-point register, FPx. FCMP does not overwrite the register specified by this field.

FDIV

Floating-Point Divide

FDIV

Operation: FPx / Source → FPx

Assembler Syntax: FDIV.fmt <ea>y,FPx
 FDIV.D FPy,FPx
 FrDIV.fmt <ea>y,FPx
 FrDIV.D FPy,FPx
 where r is rounding precision, S or D

Attributes: Format = byte, word, longword, single-precision, double-precision

Description: Converts the source operand to double-precision (if necessary) and divides it into the number in the destination floating-point data register. Stores the result in the destination floating-point data register.

FDIV rounds the result to the precision selected in FPCR. FSDIV and FDDIV round the result to single- or double-precision, respectively, regardless of the rounding precision selected in FPCR.

Operation Table:	Destination	Source ¹					
		+ In Range		- Zero		+ Infinity	
	In Range	Divide		+inf ²	-inf ²	+0.0	-0.0
				-inf ²	+inf ²	-0.0	+0.0
	Zero	+0.0	-0.0	NAN ³		+0.0	-0.0
		-0.0	+0.0			-0.0	+0.0
	Infinity	+inf	-inf	+inf	-inf	NAN ³	
		-inf	+inf	-inf	+inf		

¹ If the source operand is a NAN, refer to [Section 1.7.1.4, “Not-A-Number.”](#)

² Sets the DZ bit in the FPSR exception byte.

³ Sets the OPERR bit in the FPSR exception byte.

FPSR[FPCC]: See [Section 7.2, “Conditional Testing.”](#)

FPSR [EXC]:	BSUN	INAN	IDE	OPERR	OVFL	UNFL	DZ	INEX
0		See Table 7-2		Set for 0 ÷ 0 or x ÷ x; cleared otherwise.		See Table 7-2	Set if source is 0 and destination is in range; cleared otherwise.	See Table 7-2

FPSR[AEXC]: See [Section 7.1, “Floating-Point Status Register \(FPSR\)”](#)

FDIV

Floating-Point Divide

FDIV

Instruction Format:

15	14	13	12	11	10	9	8	7	6	5	4	3	2	1	0
1	1	1	1	0	0	1	0	0	0	Source Effective Address					
				Mode				Register							
0	R/M	0	Source Specifier			Destination Register, FPx		Opmode							

Instruction fields:

- Effective Address field—Specifies the addressing mode for external operands. If R/M = 1, this field specifies the location of the source operand, <ea>y. Only the addressing modes listed in the following table can be used.

Addressing Mode	Mode	Register	Addressing Mode	Mode	Register
Dy ¹	000	reg. number:Dy	(xxx).W	—	—
Ay	—	—	(xxx).L	—	—
(Ay)	010	reg. number: Ay	# <data>	—	—
(Ay)+	011	reg. number: Ay			
-(Ay)	100	reg. number: Ay			
(d ₁₆ ,Ay)	101	reg. number: Ay	(d ₁₆ ,PC)	111	010
(d ₈ ,Ay,Xi)	—	—	(d ₈ ,PC,Xi)	—	—

¹ Only if format is byte, word, longword or single-precision.

If R/M = 0, this field is unused and must be all zeros.

- R/M field—Specifies the source operand address mode.
 - 1: The operation is <ea>y to register.
 - 0: The operation is register to register.
- Source specifier field—Specifies the source register or data format. If R/M = 1, specifies the source data format. See [Table 7-10](#). If R/M = 0, specifies the source floating-point data register, FPy.
- Destination register field—Specifies the destination floating-point register, FPx.
- Opmode field—Specifies the instruction and rounding precision.

Opmode	Instruction	Rounding Precision
0100000	FDIV	Rounding precision specified by FPCR
1100000	FSDIV	Single-precision rounding
1100100	FDDIV	Double-precision rounding

FINT

Floating-Point Integer

FINT

Operation: Integer Part of Source → FPx

Assembler Syntax: FINT.fmt <ea>y,FPx
FINT.D FPy,FPx
FINT.D FPx

Attributes: Format = byte, word, longword, single-precision, double-precision

Description: Converts the source operand to double-precision (if necessary), extracts the integer part, and converts it to a double-precision value. Stores the result in the destination floating-point data register. The integer part is extracted by rounding the double-precision number to an integer using the current rounding mode selected in the FPCR mode control byte. Thus, the integer part returned is the number to the left of the radix point when the exponent is zero after rounding. For example, the integer part of 137.57 is 137.0 for round-to-zero and round-to-negative infinity modes and 138.0 for round-to-nearest and round-to-positive infinity modes. Note that the result of this operation is a floating-point number.

Operation Table:	Destination	Source ¹						
		+ In Range	- +	Zero	- +	Infinity	-	
	Result	Integer		+0.0		-0.0	+inf	-inf

¹ If the source operand is a NAN, refer to [Section 1.7.1.4, “Not-A-Number.”](#)

FPSR[FPCC]: See [Section 7.2, “Conditional Testing.”](#)

FPSR [EXC]:	BSUN	INAN	IDE	OPERR	OVFL	UNFL	DZ	INEX	
	0	See Table 7-2			0	0	0	0	See Table 7-2

FPSR[AEXC]: See [Section 7.1, “Floating-Point Status Register \(FPSR\)”](#)

Instruction Format:	15	14	13	12	11	10	9	8	7	6	5	4	3	2	1	0
		1	1	1	1	0	0	1	0	0	0	Source Effective Address				
				Mode			Register									
	0	R/M	0	Source Specifier			Destination Register, FPx			0	0	0	0	0	0	1

FINT

Floating-Point Integer

FINT

Instruction fields:

- Source Effective Address field—Determines the addressing mode for external operands. If R/M = 1, this field specifies the location of the source operand <ea>y. Only the addressing modes the following table can be used.

Addressing Mode	Mode	Register	Addressing Mode	Mode	Register
Dy ¹	000	reg. number:Dy	(xxx).W	—	—
Ay	—	—	(xxx).L	—	—
(Ay)	010	reg. number: Ay	# <data>	—	—
(Ay)+	011	reg. number: Ay			
-(Ay)	100	reg. number: Ay			
(d ₁₆ ,Ay)	101	reg. number: Ay	(d ₁₆ ,PC)	111	010
(d ₈ ,Ay,Xi)	—	—	(d ₈ ,PC,Xi)	—	—

¹ Only if format is byte, word, longword or single-precision.

If R/M = 0, this field is unused and should be all zeros.

- R/M field—Specifies the source operand address mode.
 - 1: The operation is <ea>y to register.
 - 0: The operation is register to register.
- Source specifier field—Specifies the source register or data format.
 - If R/M = 1, specifies the source data format. See [Table 7-10](#).
 - If R/M = 0, specifies the source floating-point data register, FPy.
- Destination register field—Specifies the destination floating-point register, FPx.
 - If R/M = 0 and the source and destination fields are equal, the input operand is taken from the specified floating-point data register, and the result is written into the same register. If the single register syntax is used, Motorola assemblers set the source and destination fields to the same value.

FINTRZ

Floating-Point Integer Round-to-Zero

FINTRZ

Operation: Integer Part of Source → FPx

Assembler Syntax: FINTRZ.fmt <ea>y,FPx
 FINTRZ.D FPy,FPx
 FINTRZ.D FPx

Attributes: Format = byte, word, longword, single-precision, double-precision

Description: Converts the source operand to double-precision (if necessary) and extracts the integer part and converts it to a double-precision number. Stores the result in the destination floating-point data register. The integer part is extracted by rounding the double-precision number to an integer using the round-to-zero mode, regardless of the rounding mode selected in the FPCR mode control byte (making it useful for FORTRAN assignments). Thus, the integer part returned is the number that is to the left of the radix point when the exponent is zero. For example, the integer part of 137.57 is 137.0. Note the result of this operation is a floating-point number.

Operation Table:	Destination	Source ¹							
		+ In Range	-	+ Zero	-	+ Infinity	-		
	Result	Integer, Forced to Round to Zero		+0.0		-0.0	+inf		-inf

¹ If the source operand is a NAN, refer to [Section 1.7.1.4, “Not-A-Number.”](#)

FPSR[FPCC]: See [Section 7.2, “Conditional Testing.”](#)

FPSR [EXC]:	BSUN	INAN	IDE	OPERR	OVFL	UNFL	DZ	INEX	
	0	See Table 7-2			0	0	0	0	See Table 7-2

FPSR[AEXC]: See [Section 7.1, “Floating-Point Status Register \(FPSR\)”](#)

Instruction Format:	15	14	13	12	11	10	9	8	7	6	5	4	3	2	1	0
	1	1	1	1	0	0	1	0	0	0	Source Effective Address					
											Mode			Register		
0	R/M	0	Source Specifier			Destination Register, FPx			0	0	0	0	0	1	1	

FINTRZ Floating-Point Integer Round-to-Zero FINTRZ

Instruction fields:

- Effective Address field—Determines the addressing mode for external operands. If R/M = 1, this field specifies the location of the source operand, <ea>y. Only the addressing modes listed in the following table can be used.

Addressing Mode	Mode	Register	Addressing Mode	Mode	Register
Dy ¹	000	reg. number:Dy	(xxx).W	—	—
Ay	—	—	(xxx).L	—	—
(Ay)	010	reg. number: Ay	# <data>	—	—
(Ay)+	011	reg. number: Ay			
-(Ay)	100	reg. number: Ay			
(d ₁₆ ,Ay)	101	reg. number: Ay	(d ₁₆ ,PC)	111	010
(d ₈ ,Ay,Xi)	—	—	(d ₈ ,PC,Xi)	—	—

¹ Only if format is byte, word, longword or single-precision.

If R/M = 0, this field is unused and should be all zeros.

- R/M field—Specifies the source operand address mode.
 - 1: The operation is <ea>y to register.
 - 0: The operation is register to register.
- Source specifier field—Specifies the source register or data format.
 - If RM = 1, specifies the source data format. See [Table 7-10](#).
 - If R/M = 0, specifies the source floating-point data register, FPy.
- Destination register field—Specifies the destination floating-point register, FPx.
 - If R/M = 0 and the source and destination fields are equal, the input operand is taken from the specified floating-point data register and the result is written into the same register. If the single register syntax is used, Motorola assemblers set the source and destination fields to the same value.

FMOVE

Move Floating-Point Data Register

FMOVE

Operation: Source → Destination

Assembler Syntax: FMOVE.fmt <ea>y,FPx
FMOVE.fmt FPy,<ea>x
FMOVE.D FPy,FPx
FrMOVE.fmt <ea>y, FPx
FrMOVE.D FPy, FPx
where r is rounding precision, S or D

Attributes: Format = byte, word, longword, single-precision, double-precision

Description: Moves the contents of the source operand to the destination operand. Although the primary function of FMOVE is data movement, it is considered an arithmetic instruction because conversions from the source operand format to the destination operand format occur implicitly. Also, the source operand is rounded according to the selected rounding precision and mode.

Unlike MOVE, FMOVE does not support a memory-to-memory format. For such transfers, MOVE is much faster than FMOVE to transfer floating-point data. FMOVE supports memory-to-register, register-to-register, and register-to-memory operations (memory here can include an integer data register if the format is byte, word, longword, or single-precision). Memory- and register-to-register operations use a command word encoding different from that used by the register-to-memory operation; these two operation classes are described separately.

Memory- and register-to-register operations (<ea>y,FPx; FPy,FPx): Converts the source operand to a double-precision number (if necessary) and stores it in the destination floating-point data register, FPx. FMOVE rounds the result to the precision selected in FPCR. FSMOVE and FDMOVE round the result to single- and double-precision, regardless of the rounding selected in FPCR. Note that if the source format is longword or double precision, inexact results may be created when rounding to single precision. All other combinations of source formats and rounding precision produce an exact result.

FPSR[FPCC]: See [Section 7.2, “Conditional Testing.”](#)

FPSR [EXC]:	BSUN	INAN	IDE	OPERR	OVFL	UNFL	DZ	INEX
	0	See Table 7-2			0	0	0	See Table 7-2

FPSR[AEXC]: See [Section 7.1, “Floating-Point Status Register \(FPSR\)”](#)

FMOVE

Move Floating-Point Data Register

FMOVE

Instruction Format:
 $\langle ea \rangle y, FPx$
 FPy, FPx

15	14	13	12	11	10	9	8	7	6	5	4	3	2	1	0			
1	1	1	1	0	0	1	0	0	0	Source Effective Address								
				Source Specifier				Destination Register, FPx				Opmode						
0	R/M	0									Mode				Register			

Instruction fields:

- Effective address field—Determines the addressing mode for external operands. If R/M = 1, this field specifies the location of the source operand. Only the addressing modes listed in the following table can be used.

Addressing Mode	Mode	Register	Addressing Mode	Mode	Register
Dy ¹	000	reg. number:Dy	(xxx).W	—	—
Ay	—	—	(xxx).L	—	—
(Ay)	010	reg. number: Ay	# <data>	—	—
(Ay)+	011	reg. number: Ay			
-(Ay)	100	reg. number: Ay			
(d ₁₆ , Ay)	101	reg. number: Ay	(d ₁₆ , PC)	111	010
(d ₈ , Ay, Xi)	—	—	(d ₈ , PC, Xi)	—	—

¹ Only if format is byte, word, longword or single-precision.

If R/M = 0, this field is unused and must be all zeros.

- R/M field—Specifies the source operand address mode. If R/M = 0 the operation is register to register. If R/M = 1 the operation is $\langle ea \rangle y$ to register.
- Source specifier field—Specifies the source register or data format. If R/M = 0, specifies the source floating-point data register, FPy. If R/M = 1, specifies the source data format. See [Table 7-10](#).
- Destination register field—Specifies the destination floating-point register, FPx.
- Opmode field—Specifies the instruction and rounding precision.

Opmode	Instruction	Rounding Precision
0000000	FMOVE	Rounding precision specified by the FPCR
1000000	FSMOVE	Single-precision rounding
1000100	FDMOVE	Double-precision rounding

FMOVE

Move Floating-Point Data Register

FMOVE

Register-to-memory operation (FPy,<ea>x): Rounds the source operand to the specified destination format and stores it at the destination effective address, <ea>x.

FPSR[FPCC]: Not affected.

FPSR [EXC]: format = .B, .W, or .L	BSUN	INAN	IDE	OPERR	OVFL	UNFL	DZ	INEX
	0	See Table 7-2		Set if source operand is x or if destination size is exceeded after conversion and rounding; cleared otherwise.	0	0	0	See Table 7-2
format = .S or .D				0	See Table 7-2		0	

FPSR[AEXC]: See Section 7.1, “Floating-Point Status Register (FPSR)”

Instruction Format FPy,<ea>x:	15	14	13	12	11	10	9	8	7	6	5	4	3	2	1	0	
	1	1	1	1	0	0	1	0	0	0	Destination Effective Address						
					Destination Format				Source Register, FPy				Mode		Register		
0	1	1	Destination Format				Source Register, FPy				0	0	0	0	0	0	0

Instruction fields:

- Destination Effective Address field—Specifies the destination location, <ea>x. Only modes in the following table can be used.

Addressing Mode	Mode	Register	Addressing Mode	Mode	Register
Dx ¹	000	reg. number:Dx	(xxx).W	—	—
Ax	—	—	(xxx).L	—	—
(Ax)	010	reg. number:Ax	# <data>	—	—
(Ax)+	011	reg. number:Ax			
-(Ax)	100	reg. number:Ax			
(d ₁₆ ,Ax)	101	reg. number:Ax	(d ₁₆ ,PC)	—	—
(d ₈ ,Ay,Xi)	—	—	(d ₈ ,PC,Xi)	—	—

¹ Only if format is byte, word, longword or single-precision.

- Destination Format field—Specifies the data format of the destination operand. See Table 7-10.
- Source Register field—Specifies the source floating-point data register, FPy.

FMOVE from FPCR

Move from the Floating
Point Control Register

FMOVE from FPCR

Operation: FPCR → Destination

Assembler syntax: FMOVE.L FPCR,<ea>x

Attributes: Format = longword

Description: Moves the contents of the FPCR to an effective address. A 32-bit transfer is always performed, even though the FPCR does not have 32 implemented bits. Unimplemented bits of a control register are read as zeros. Exceptions are not taken upon execution of this instruction.

FPSR: Not affected

**Instruction
Format:**

15	14	13	12	11	10	9	8	7	6	5	4	3	2	1	0
1	1	1	1	0	0	1	0	0	0	Destination Effective Address					
										Mode		Register			
1	0	1	1	0	0	0	0	0	0	0	0	0	0	0	0

Instruction field:

- Effective Address field—Specifies the addressing mode, <ea>x, shown in the following table:

Addressing Mode	Mode	Register	Addressing Mode	Mode	Register
Dx	000	reg. number:Dx	(xxx).W	—	—
Ax	—	—	(xxx).L	—	—
(Ax)	010	reg. number:Ax	# <data>	—	—
(Ax)+	011	reg. number:Ax			
-(Ax)	100	reg. number:Ax			
(d ₁₆ ,Ax)	101	reg. number:Ax	(d ₁₆ ,PC)	—	—
(d ₈ ,Ax,Xi)	—	—	(d ₈ ,PC,Xi)	—	—

FMOVE from FPIAR

Move from the Floating
Point Instruction Address Register

FMOVE from FPIAR

Operation: FPIAR → Destination

Assembler syntax: FMOVE.L FPIAR,<ea>x

Attributes: Format = longword

Description: Moves the contents of the floating-point instruction address register to an effective address. Exceptions are not taken upon execution of this instruction.

FPSR: Not affected

Instruction Format:

15	14	13	12	11	10	9	8	7	6	5	4	3	2	1	0
1	1	1	1	0	0	1	0	0	0	Destination Effective Address					
										Mode		Register			
1	0	1	0	0	1	0	0	0	0	0	0	0	0	0	0

Instruction field:

- Effective Address field—Specifies the addressing mode, <ea>x, shown in the following table:

Addressing Mode	Mode	Register	Addressing Mode	Mode	Register
Dx	000	reg. number:Dx	(xxx).W	—	—
Ax	001	reg. number:Ax	(xxx).L	—	—
(Ax)	010	reg. number:Ax	# <data>	—	—
(Ax)+	011	reg. number:Ax			
-(Ax)	100	reg. number:Ax			
(d ₁₆ ,Ax)	101	reg. number:Ax	(d ₁₆ ,PC)	—	—
(d ₈ ,Ax,Xi)	—	—	(d ₈ ,PC,Xi)	—	—

FMOVE from FPSR

Move from the Floating
Point Status Register

FMOVE from FPSR

Operation: FPSR → Destination

Assembler syntax: FMOVE.L FPSR,<ea>x

Attributes: Format = longword

Description: Moves the contents of the FPSR to an effective address. A 32-bit transfer is always performed, even though the FPSR does not have 32 implemented bits. Unimplemented bits of a control register are read as zeros. Exceptions are not taken upon execution of this instruction.

FPSR: Not affected

**Instruction
Format:**

15	14	13	12	11	10	9	8	7	6	5	4	3	2	1	0
1	1	1	1	0	0	1	0	0	0	Destination Effective Address					
										Mode		Register			
1	0	1	0	1	0	0	0	0	0	0	0	0	0	0	0

Instruction field:

- Effective Address field—Specifies the addressing mode, <ea>x, shown in the following table:

Addressing Mode	Mode	Register	Addressing Mode	Mode	Register
Dx	000	reg. number:Dx	(xxx).W	—	—
Ax	—	—	(xxx).L	—	—
(Ax)	010	reg. number:Ax	# <data>	—	—
(Ax)+	011	reg. number:Ax			
-(Ax)	100	reg. number:Ax			
(d ₁₆ ,Ax)	101	reg. number:Ax	(d ₁₆ ,PC)	—	—
(d ₈ ,Ax,Xi)	—	—	(d ₈ ,PC,Xi)	—	—

FMOVE to FPCR

Move to the Floating Point Control Register

FMOVE to FPCR

Operation: Source → FPCR

Assembler syntax: FMOVE.L <ea>y,FPCR

Attributes: Format = longword

Description: Loads the FPCR from an effective address. A 32-bit transfer is always performed, even though the FPCR does not have 32 implemented bits. Unimplemented bits are ignored during writes (must be zero for compatibility with future devices). Exceptions are not taken upon execution of this instruction.

FPSR: Not affected.

Instruction

Format:

15	14	13	12	11	10	9	8	7	6	5	4	3	2	1	0
1	1	1	1	0	0	1	0	0	0	Source Effective Address					
										Mode		Register			
1	0	0	1	0	0	0	0	0	0	0	0	0	0	0	0

Instruction field:

- Effective Address field—Specifies the addressing mode, <ea>y, shown in the following table:

Addressing Mode	Mode	Register	Addressing Mode	Mode	Register
Dy	000	reg. number:Dy	(xxx).W	—	—
Ay	—	—	(xxx).L	—	—
(Ay)	010	reg. number:Ay	# <data>	—	—
(Ay)+	011	reg. number:Ay			
-(Ay)	100	reg. number:Ay			
(d ₁₆ ,Ay)	101	reg. number:Ay	(d ₁₆ ,PC)	111	010
(d ₈ ,Ay,Xi)	—	—	(d ₈ ,PC,Xi)	—	—

FMOVE to FPIAR

Move to the Floating Point Instruction Address Register

FMOVE to FPIAR

Operation: Source → FPIAR

Assembler syntax: FMOVE.L <ea>y,FPIAR

Attributes: Format = longword

Description: Loads the floating-point instruction address register from an effective address. Exceptions are not taken upon execution of this instruction.

FPSR: Not affected.

Instruction Format:

15	14	13	12	11	10	9	8	7	6	5	4	3	2	1	0
1	1	1	1	0	0	1	0	0	0	Source Effective Address					
										Mode			Register		
1	0	0	0	0	1	0	0	0	0	0	0	0	0	0	0

Instruction field:

- Effective Address field—Specifies the addressing mode, <ea>y, shown in the following table:

Addressing Mode	Mode	Register	Addressing Mode	Mode	Register
Dy	000	reg. number:Dy	(xxx).W	—	—
Ay	001	reg. number:Ay	(xxx).L	—	—
(Ay)	010	reg. number:Ay	# <data>	—	—
(Ay)+	011	reg. number:Ay			
-(Ay)	100	reg. number:Ay			
(d ₁₆ ,Ay)	101	reg. number:Ay	(d ₁₆ ,PC)	111	010
(d ₈ ,Ay,Xi)	—	—	(d ₈ ,PC,Xi)	—	—

FMOVE to FPSR

Move to the Floating Point Status Register

FMOVE to FPSR

Operation: Source → FPSR

Assembler syntax: FMOVE.L <ea>y,FPSR

Attributes: Format = longword

Description: Loads the FPSR from an effective address. A 32-bit transfer is always performed, even though the FPSR does not have 32 implemented bits. Unimplemented bits are ignored during writes (must be zero for compatibility with future devices). Exceptions are not taken upon execution of this instruction.

FPSR: All bits are modified to reflect the source operand value.

Instruction

Format:

15	14	13	12	11	10	9	8	7	6	5	4	3	2	1	0
1	1	1	1	0	0	1	0	0	0	Source Effective Address					
										Mode		Register			
1	0	0	0	1	0	0	0	0	0	0	0	0	0	0	0

Instruction field:

- Effective Address field—Specifies the addressing mode, <ea>y, shown in the following table:

Addressing Mode	Mode	Register	Addressing Mode	Mode	Register
Dy	000	reg. number:Dy	(xxx).W	—	—
Ay	—	—	(xxx).L	—	—
(Ay)	010	reg. number:Ay	# <data>	—	—
(Ay)+	011	reg. number:Ay			
-(Ay)	100	reg. number:Ay			
(d ₁₆ ,Ay)	101	reg. number:Ay	(d ₁₆ ,PC)	111	010
(d ₈ ,Ay,Xi)	—	—	(d ₈ ,PC,Xi)	—	—

FMOVEM

Move Multiple Floating-Point Data Registers

FMOVEM

Operation: Register List → Destination
Source → Register List

Assembler syntax: FMOVEM.D #list,<ea>x
FMOVEM.D <ea>y,#list

Attributes: Format = double-precision

Description: Moves one or more double-precision numbers to or from a list of floating-point data registers. No conversion or rounding is performed during this operation, and the FPSR is not affected by the instruction. Exceptions are not taken upon execution of this instruction. Any combination of the eight floating-point data registers can be transferred, with selected registers specified by a user-supplied mask. This mask is an 8-bit number, where each bit corresponds to one register; if a bit is set in the mask, that register is moved. Note that a null register list (all zeros) generates a line F exception.

FMOVEM allows two addressing modes: address register indirect and base register plus 16-bit displacement, where the base is an address register, or for loads only, the program counter. In all cases, the processor calculates the starting address and then increments by 8 bytes for each register moved. The transfer order is always FP0-FP7.

NOTE

FMOVEM offers the only way to move floating-point data between the FPU and memory without converting data or affecting condition code and exception status bits.

FPSR: Not affected.

Instruction Format:

15	14	13	12	11	10	9	8	7	6	5	4	3	2	1	0
1	1	1	1	0	0	1	0	0	0	Effective Address					
										Mode		Register			
1	1	dr	1	0	0	0	0	Register List							

FMOVEM Move Multiple Floating-Point Data Registers FMOVEM

Instruction fields:

- Effective address field—Specifies the addressing mode. For memory-to-register the allowed <ea>y modes are shown in the following table:

Addressing Mode	Mode	Register	Addressing Mode	Mode	Register
Dy	—	—	(xxx).W	—	—
Ay	—	—	(xxx).L	—	—
(Ay)	010	reg. number: Ay	# <data>	—	—
(Ay)+	—	—			
-(Ay)	—	—			
(d ₁₆ ,Ay)	101	reg. number: Ay	(d ₁₆ ,PC)	111	010
(d ₈ ,Ay,Xi)	—	—	(d ₈ ,PC,Xi)	—	—

- Effective address field—Specifies the addressing mode. For register-to-memory the allowed <ea>x modes are shown in the following table:

Addressing Mode	Mode	Register	Addressing Mode	Mode	Register
Dx	—	—	(xxx).W	—	—
Ax	—	—	(xxx).L	—	—
(Ax)	010	reg. number: Ax	# <data>	—	—
(Ax)+	—	—			
-(Ax)	—	—			
(d ₁₆ ,Ax)	101	reg. number: Ax	(d ₁₆ ,PC)	—	—
(d ₈ ,Ax,Xi)	—	—	(d ₈ ,PC,Xi)	—	—

- dr field—Specifies the direction of the transfer.
 - 0: Move the listed registers from memory to the FPU.
 - 1: Move the listed registers from the FPU to memory.
- Register list field—Contains the register select mask. If a register is to be moved, the corresponding mask bit is set as shown below; otherwise it is zero.

7	6	5	4	3	2	1	0
FP0	FP1	FP2	FP3	FP4	FP5	FP6	FP7

FMUL

Floating-Point Multiply

FMUL

Operation: Source * FPx → FPx

Assembler syntax: FMUL.fmt <ea>y,FPx
 FMUL.D FPy,FPx
 FrMUL.fmt <ea>y,FPx
 FrMUL.D FPy,FPx
 where r is rounding precision, S or D

Attributes: Format = byte, word, longword, single-precision, double-precision

Description: Converts source operand to double-precision (if necessary) and multiplies that number by the number in destination floating-point data register. Stores result in the destination floating-point data register.

FMUL rounds the result to the precision selected in FPCR. FSMUL and FDMUL round the result to single- or double-precision, respectively, regardless of the rounding precision selected in FPCR.

Operation Table:	Destination	Source ¹								
		+	In Range	-	+	Zero	-	+	Infinity	-
	In Range	+	Multiply	-	+0.0	-0.0	+0.0	-0.0	+inf	-inf
		-		-0.0	+0.0	-0.0	+0.0	-inf	+inf	
	Zero	+	+0.0	-0.0	+0.0	-0.0	+0.0	-0.0	NaN ²	
		-	-0.0	+0.0	-0.0	+0.0	-0.0	+0.0		
	Infinity	+	+inf	-inf	NaN ²		+inf	-inf	+inf	-inf
		-	-inf	+inf			-inf	+inf	-inf	+inf

¹ If the source operand is a NaN, refer to [Section 1.7.1.4, “Not-A-Number.”](#)

² Sets the OPERR bit in the FPSR exception byte.

FPSR[FPCC]: See [Section 7.2, “Conditional Testing.”](#)

FPSR [EXC]:	BSUN	INAN	IDE	OPERR	OVFL	UNFL	DZ	INEX
0		See Table 7-2		Set for 0 x x; cleared otherwise.	See Table 7-2		0	See Table 7-2

FPSR[AEXC]: See [Section 7.1, “Floating-Point Status Register \(FPSR\)”](#)

Instruction Format:	15	14	13	12	11	10	9	8	7	6	5	4	3	2	1	0
		1	1	1	1	0	0	1	0	0	0	Source Effective Address				
										Mode			Register			
	0	R/M	0	Source Specifier			Destination Register, FPx			Opmode						

FMUL

Floating-Point Multiply

FMUL

Instruction fields:

- Effective address field—Determines the addressing mode for external operands. If R/M = 1, this field specifies the location of the source operand. Only the addressing modes listed in the following table can be used.

Addressing Mode	Mode	Register	Addressing Mode	Mode	Register
Dy ¹	000	reg. number:Dy	(xxx).W	—	—
Ay	—	—	(xxx).L	—	—
(Ay)	010	reg. number: Ay	# <data>	—	—
(Ay)+	011	reg. number: Ay			
-(Ay)	100	reg. number: Ay			
(d ₁₆ , Ay)	101	reg. number: Ay	(d ₁₆ , PC)	111	010
(d ₈ , Ay, Xi)	—	—	(d ₈ , PC, Xi)	—	—

¹ Only if format is byte, word, longword or single-precision.

If R/M = 0, this field is unused and must be all zeros.

- R/M field—Specifies the source operand address mode.
 - 1: The operation is <ea>y to register.
 - 0: The operation is register to register.
- Source specifier field—Specifies the source register or data format. If R/M = 1, specifies the source data format. See [Table 7-10](#). If R/M = 0, specifies the source floating-point data register, FPy.
- Destination register field—Specifies the destination floating-point register, FPx.
- Opmode field—Specifies the instruction and rounding precision.

Opmode	Instruction	Rounding Precision
0100011	FMUL	Rounding precision specified by the FPCR
1100011	FSMUL	Single-precision rounding
1100111	FDMUL	Double-precision rounding

FNEG

Floating-Point Negate

FNEG

Operation: $-(\text{Source}) \rightarrow \text{FPx}$

Assembler syntax: FNEG.fmt <ea>y,FPx
 FNEG.D FPy,FPx
 FNEG.D FPx
 FrNEG.fmt <ea>y,FPx
 FrNEG.D FPy,FPx
 FrNEG.D FPx
 where r is rounding precision, S or D

Attributes: Format = byte, word, longword, single-precision, double-precision

Description: Converts the source operand to double-precision (if necessary) and inverts the sign of the mantissa. Stores the result in the destination floating-point data register, FPx.

FNEG rounds the result to the precision selected in the FPCR. FSNEG and FDNEG round the result to single- or double-precision, respectively, regardless of the rounding precision selected in the FPCR.

Operation Table:	Destination	Source ¹									
		+	In Range	-	+	Zero	-	+	Infinity	-	
	Result		Negate		-0.0		+0.0		-inf		+inf

¹ If the source operand is a NAN, refer to [Section 1.7.1.4, “Not-A-Number.”](#)

FPSR[FPCC]: See [Section 7.2, “Conditional Testing.”](#)

FPSR [EXC]:	BSUN	INAN	IDE	OPERR	OVFL	UNFL	DZ	INEX
	0	See Table 7-2		0	0	0	0	0

FPSR[AEXC]: See [Section 7.1, “Floating-Point Status Register \(FPSR\)”](#)

Instruction Format:	15	14	13	12	11	10	9	8	7	6	5	4	3	2	1	0
	1	1	1	1	0	0	1	0	0	0	Source Effective Address					
											Mode		Register			
0	R/M	0	Source Specifier			Destination Register, FPx			Opmode							

FNEG

Floating-Point Negate

FNEG

Instruction fields:

- Effective Address field—Determines the addressing mode for external operands. If R/M = 1, this field specifies the location of the source operand. Only modes in the following table can be used.

Addressing Mode	Mode	Register	Addressing Mode	Mode	Register
Dy ¹	000	reg. number:Dy	(xxx).W	—	—
Ay	—	—	(xxx).L	—	—
(Ay)	010	reg. number: Ay	# <data>	—	—
(Ay)+	011	reg. number: Ay			
-(Ay)	100	reg. number: Ay			
(d ₁₆ ,Ay)	101	reg. number: Ay	(d ₁₆ ,PC)	111	010
(d ₈ ,Ay,Xi)	—	—	(d ₈ ,PC,Xi)	—	—

¹ Only if format is byte, word, longword or single-precision.

If R/M = 0, this field is unused and must be all zeros.

- R/M field—Specifies the source operand address mode.
 - 1: The operation is <ea>y to register.
 - 0: The operation is register to register.
- Source specifier field—Specifies the source register or data format. If R/M = 1, specifies the source data format. See [Table 7-10](#). If R/M = 0, specifies the source floating-point data register, FPy.
- Destination register field—Specifies the destination floating-point register, FPx. If R/M = 0 and the source and destination fields are equal, the input operand is taken from the specified floating-point data register and the result is written into the same register. If the single register syntax is used, Motorola assemblers set the source and destination fields to the same value.
- Opmode field—Specifies the instruction and rounding precision.

Opmode	Instruction	Rounding Precision
0011010	FNEG	Rounding precision specified by the FPCR
1011010	FSNEG	Single-precision rounding
1011110	FDNEG	Double-precision rounding

FNOP

No Operation

FNOP

Operation: None

Assembler syntax: FNOP

Attributes: Unsized

Description: FNOP performs no explicit operation. It is used to synchronize the FPU with an integer unit or to force processing of pending exceptions. For most floating-point instructions, the integer unit can continue executing the next instruction once the FPU has any operands needed for an operation, thus supporting concurrent execution of integer and floating-point instructions. FNOP causes the integer unit to wait for all previous floating-point instructions to complete. It also forces any exceptions pending from the execution of a previous floating-point instruction to be processed as a pre-instruction exception. The opcode for FNOP is 0xF280 0000.

FPSR: Not affected.

Instruction Format:

15	14	13	12	11	10	9	8	7	6	5	4	3	2	1	0
1	1	1	1	0	0	1	0	1	0	0	0	0	0	0	0
0	0	0	0	0	0	0	0	0	0	0	0	0	0	0	0

NOTE

FNOP uses the same opcode as the FBcc.W <label> instruction, with cc = F (nontrapping false) and <label> = + 2 (which results in a displacement of 0).

FSQRT

Floating-Point Square Root

FSQRT

Operation: Square Root of Source → FPx

Assembler syntax: FSQRT.fmt <ea>y,FPx
 FSQRT.D FPy,FPx
 FSQRT.D FPx
 FrSQRT.fmt <ea>y,FPx
 FrSQRT.D FPy,FPx
 FrSQRT.D FPx
 where r is rounding precision, S or D

Attributes: Format = byte, word, longword, single-precision, double-precision

Description: Converts the source operand to double-precision (if necessary) and calculates the square root of that number. Stores the result in the destination floating-point data register, FPx. This function is not defined for negative operands.

FSQRT rounds the result to the precision selected in the FPCR. FSFSQRT and FDFSQRT round the result to single- or double-precision, respectively, regardless of the rounding precision selected in the FPCR.

Operation Table:	Destination	Source ¹									
		+	In Range	-	+	Zero	-	+	Infinity	-	
	Result	\sqrt{x}	NAN ²	+0.0	-0.0	+inf	NAN ²				

¹ If the source operand is a NAN, refer to [Section 1.7.1.4, “Not-A-Number.”](#)

² Sets the OPERR bit in the FPCR exception byte.

FPCR[FPCC]: See [Section 7.2, “Conditional Testing.”](#)

FPCR [EXC]:	BSUN	INAN	IDE	OPERR	OVFL	UNFL	DZ	INEX
0		See Table 7-2		Set if the source operand is not 0 and is negative; cleared otherwise.	0	0	0	See Table 7-2

FPCR[AEXC]: See [Section 7.1, “Floating-Point Status Register \(FPCR\)”](#)

Instruction Format:	15	14	13	12	11	10	9	8	7	6	5	4	3	2	1	0
	1	1	1	1	0	0	1	0	0	0	Source Effective Address					
											Mode			Register		
0	R/M	0	Source Specifier			Destination Register, FPx			Opmode							

FSQRT

Floating-Point Square Root

FSQRT

Instruction fields:

- Effective address field—Specifies the addressing mode for external operands. If R/M = 1, this field specifies the location of the source operand, <ea>y. Only modes in the following table can be used.

Addressing Mode	Mode	Register	Addressing Mode	Mode	Register
Dy ¹	000	reg. number:Dy	(xxx).W	—	—
Ay	—	—	(xxx).L	—	—
(Ay)	010	reg. number:Ay	# <data>	—	—
(Ay)+	011	reg. number:Ay			
-(Ay)	100	reg. number:Ay			
(d ₁₆ ,Ay)	101	reg. number:Ay	(d ₁₆ ,PC)	111	010
(d ₈ ,Ay,Xi)	—	—	(d ₈ ,PC,Xi)	—	—

¹ Only if format is byte, word, longword or single-precision.

If R/M = 0, this field is unused and must be all zeros.

- R/M field—Specifies the source operand address mode.
 - 1: The operation is <ea>y to register.
 - 0: The operation is register to register.
- Source specifier field—Specifies the source register or data format. If R/M = 1, specifies the source data format. See [Table 7-10](#). If R/M = 0, specifies the source floating-point data register, FPy.
- Destination register field—Specifies the destination floating-point register, FPx. If R/M = 0 and source and destination fields are equal, the input operand comes from the specified floating-point data register, and the result is written into the same register. If single register syntax is used, Motorola assemblers set the source and destination fields to the same value.
- Opmode field—Specifies the instruction and rounding precision.

Opmode	Instruction	Rounding Precision
0000100	FSQRT	Rounding precision specified by the FPCR
1000001	FSSQRT	Single-precision rounding
1000101	FDSQRT	Double-precision rounding

FSUB

Floating-Point Subtract

FSUB

Operation: FPx – Source → FPx

Assembler syntax: FSUB.fmt <ea>y,FPx
 FSUB.D FPy,FPx
 FrSUB.fmt <ea>y,FPx
 FrSUB.D FPy,FPx
 where r is rounding precision, S or D

Attributes: Format = byte, word, longword, single-precision, double-precision

Description: Converts the source operand to double-precision (if necessary) and subtracts it from the number in the destination floating-point data register. Stores the result in the destination floating-point data register.

Operation Table:	Destination	Source ¹									
		+	In Range	-	+	Zero	-	+	Infinity	-	
	In Range	+	Subtract	-	+	Subtract	-	+	-inf	-	+inf
	Zero	+	Subtract	-	+	0.0 ² -0.0	-	+	+0.0 0.0 ²	-	-inf +inf
	Infinity	+	+inf -inf	-	+	+inf -inf	-	+	NAN ³ -inf	-	+inf NAN ³

¹ If the source operand is a NAN, refer to [Section 1.7.1.4, “Not-A-Number.”](#)

² Returns +0.0 in rounding modes RN, RZ, and RP; returns -0.0 in RM.

³ Sets the OPERR bit in the FPSR exception byte.

FPSR[FPCC]: See [Section 7.2, “Conditional Testing.”](#)

FPSR [EXC]:	BSUN	INAN	IDE	OPERR	OVFL	UNFL	DZ	INEX
0		See Table 7-2		Set if source and destination are like-signed infinities; cleared otherwise.		See Table 7-2	0	See Table 7-2

FPSR[AEXC]: See [Section 7.1, “Floating-Point Status Register \(FPSR\).”](#)

Instruction Format:	15	14	13	12	11	10	9	8	7	6	5	4	3	2	1	0
		1	1	1	1	0	0	1	0	0	0	Source Effective Address				
											Mode		Register			
	0	R/M	0	Source Specifier			Destination Register, FPx			Opmode						

FSUB

Floating-Point Subtract

FSUB

Instruction fields:

- Effective address field—Determines the addressing mode for external operands. If R/M = 1, this field specifies the location of the source operand, <ea>y. Only the addressing modes listed in the following table can be used.

Addressing Mode	Mode	Register	Addressing Mode	Mode	Register
Dy ¹	000	reg. number:Dy	(xxx).W	—	—
Ay	—	—	(xxx).L	—	—
(Ay)	010	reg. number:Ay	# <data>	—	—
(Ay)+	011	reg. number:Ay			
-(Ay)	100	reg. number:Ay			
(d ₁₆ ,Ay)	101	reg. number:Ay	(d ₁₆ ,PC)	111	010
(d ₈ ,Ay,Xi)	—	—	(d ₈ ,PC,Xi)	—	—

¹ Only if format is byte, word, longword or single-precision.

If R/M = 0, this field is unused and must be all zeros.

- R/M field—Specifies the source operand address mode.
 - 1: The operation is <ea>y to register.
 - 0: The operation is register to register.
- Source Specifier field—Specifies the source register or data format. If R/M = 1, specifies the source data format. See [Table 7-10](#). If R/M = 0, specifies the source floating-point data register, FPy.
- Destination register field—Specifies the destination floating-point register, FPx.
- Opmode field—Specifies the instruction and rounding precision.

Opmode	Instruction	Rounding Precision
0101000	FSUB	Rounding precision specified by the FPCR
1101000	FSSUB	Single-precision rounding
1101100	FDSUB	Double-precision rounding

FTST

Test Floating-Point Operand

FTST

Operation: Source Operand Tested → FPCC

Assembler syntax: FTST.fmt <ea>y
FTST.D FPy

Attributes: Format = byte, word, longword, single-precision, double-precision

Description: Converts the source operand to double-precision (if necessary) and sets the condition code bits according to the data type of the result. Note that for denormalized operands, FPCC[Z] is set because denormalized numbers are normally treated as zero. When Z is set, INEX is set if the operand is a denormalized number (and IDE is disabled). INEX is cleared if the operand is exactly zero.

Operation Table:	Destination	Source ¹							
		+ In Range	-	+ Zero	-	+ Infinity	-		
Result	none		N	Z		NZ	I		NI

¹ If the source operand is a NAN, refer to [Section 1.7.1.4, “Not-A-Number.”](#)

Note that the operation table differs from other operation tables. A letter in a table entry indicates that FTST always sets the designated condition code bit. All unspecified condition code bits are cleared during the operation.

FPSR[FPCC]: See [Section 7.2, “Conditional Testing.”](#)

FPSR [EXC]:	BSUN	INAN	IDE	OPERR	OVFL	UNFL	DZ	INEX
0		See Table 7-2		0	0	0	0	Set if denormalized and IDE is disabled; cleared otherwise

FPSR[AEXC]: See [Section 7.1, “Floating-Point Status Register \(FPSR\)”](#)

Instruction Format:	15	14	13	12	11	10	9	8	7	6	5	4	3	2	1	0
	1	1	1	1	0	0	1	0	0	0	Source Effective Address					
											Mode			Register		
0	R/M	0	Source Specifier			Destination Register, FPx			0	1	1	1	0	1	0	

FTST

Test Floating-Point Operand

FTST

Instruction fields:

- Effective address field—Determines the addressing mode for external operands. If R/M = 1, this field specifies the source operand location, <ea>y. Only modes in the following table can be used.

Addressing Mode	Mode	Register	Addressing Mode	Mode	Register
Dy ¹	000	reg. number:Dy	(xxx).W	—	—
Ay	—	—	(xxx).L	—	—
(Ay)	010	reg. number: Ay	# <data>	—	—
(Ay)+	011	reg. number: Ay			
-(Ay)	100	reg. number: Ay			
(d ₁₆ , Ay)	101	reg. number: Ay	(d ₁₆ , PC)	111	010
(d ₈ , Ay, Xi)	—	—	(d ₈ , PC, Xi)	—	—

¹ Only if format is byte, word, longword or single-precision.

If R/M = 0, this field is unused and must be all zeros.

- R/M field—Specifies the source operand address mode.
 - 1: The operation is <ea>y to register.
 - 0: The operation is register to register.
- Source specifier field—Specifies the source register or data format.
 - If R/M = 1, specifies the source data format. See [Table 7-10](#).
 - If R/M = 0, specifies the source floating-point data register, FPx.
- Destination register field—FTST uses the command word format used by all FPU arithmetic instructions but ignores and does not overwrite the register specified by this field. This field should be cleared for compatibility with future devices; however, because this field is ignored for the FTST instruction, the FPU does not signal an exception if the field is not zero.



THIS PAGE INTENTIONALLY LEFT BLANK

Chapter 8

Supervisor (Privileged) Instructions

This section contains information about the supervisor (privileged) instructions for the ColdFire Family. Each instruction is described in detail with the instruction descriptions arranged in alphabetical order by instruction mnemonic. Supervisor instructions for optional core modules (for example, the floating-point unit) are also detailed in this section.

Not all instructions are supported by all ColdFire processors. See [Chapter 3, “Instruction Set Summary](#) for specific details on the instruction set definitions.

CPUSHL

Push and Possibly Invalidate Cache First appeared in ISA_A

CPUSHL

Operation: If Supervisor State
 Then if Data Valid and Modified
 Push Cache Line
 Then Invalidate Line if Programmed in CACR
 Else Privilege Violation Exception

Assembler Syntax: CPUSHL dc,(Ax) data cache
 CPUSHL ic,(Ax) instruction cache
 CPUSHL bc,(Ax) both caches or unified cache

Attributes: Unsized

Description: Pushes a specified cache line if modified and invalidates it if programmed to do so by CACR[DPI]. Care should be exercised when clearing lines from both caches if the sizes of the caches are different. For example, using a device with a 16K instruction cache and an 8K data cache, an address of 0x800 applied to both caches is referencing cache address 0x80 of the instruction cache, but address 0x00 of the data cache. Note that this instruction synchronizes the pipeline.

Condition Codes: Not affected

Instruction Format:	15	14	13	12	11	10	9	8	7	6	5	4	3	2	1	0
	1	1	1	1	0	1	0	0	Cache	1	0	1	Register, Ax			

Instruction Fields:

- Cache — Specifies the affected cache as follows:
 - 00 reserved
 - 01 data cache (dc)
 - 10 instruction cache (ic)
 - 11 both caches or unified cache (bc); also use this encoding for a device which has an instruction cache, but not a data cache
- Register, Ax — Specifies the address register defining the line within the cache to be pushed or invalidated. Ax should be programmed as follows:
 - Ax[4] is the lsb for the address field, which extends upward as required by the given cache size. The algorithm for the size of the address field is as follows:
 $\text{Range} = \text{Cache size in bytes} / (\text{Associativity} * 16)$
 Using a 16K, 4 way set-associative cache as an example:
 $\text{Range} = 16384 / (4 * 16) = 256 = 2^8$
 Thus, the address range for this cache would be Ax[11:4]
 - Ax[1:0] specify the cache way or level where the line is located.

FRESTORE

Restore Internal Floating-Point State

First appeared in ISA_A

FRESTORE

Operation: If in Supervisor State
Then FPU State Frame → Internal State
Else Privilege Violation Exception

Assembler syntax: FRESTORE <ea>y

Attributes: Unsized

Description: Aborts any floating-point operation and loads a new FPU internal state from the state frame at the effective address. The frame format is specified in the byte at <ea>y, and an internal exception vector is contained in the byte at <ea>y+1. If the frame format is invalid, FRESTORE aborts and a format exception is generated (vector 14). If the format is valid, the frame is loaded into the FPU, starting at the specified location and proceeding through higher addresses.

FRESTORE ignores the vector specified in the byte at <ea>y+1 because all vectors are generated from FPCR and FPSR exception bits. This vector is provided for the handler.

FRESTORE does not normally affect the FPU programming model except the NULL state frame. It is generally used with FMOVEM to fully restore the FPU context including floating-point data and system control registers. For complete restoration, FMOVEM first loads the data registers, then FRESTORE loads the internal state, FPCR, and FPSR. Table 8-1 lists supported state frames. If the frame format is not 0x00, 0x05, or 0xE5, the processor responds with a format error exception, vector 14, and the internal FPU state is unaffected.

Table 8-1. State Frames

State	Format	Description
NULL	0x00	FRESTORE of this state frame is like a hardware reset of the FPU. The programmer's model enters reset state, with NaNs in floating-point data registers and zeros in FPCR, FPSR, and FPIAR.
IDLE	0x05	A FRESTORE of the IDLE or EXCP state frame yields the same results. The FPU is restored to idle state, waiting for initiation of the next instruction, with no exceptions pending. However, if an FPSR[EXC] bit and corresponding FPCR enable bit are set, the FPU enters exception state. In this state, initiating a floating-point instruction other than FSAVE, FMOVEM, FMOVE of system registers, or another FRESTORE causes a pending exception. The programmer's model is unaffected by loading this type of state frame (except FPSR and FPCR are loaded from the state frame).
EXCP	0xE5	

FPSR: Cleared if NULL frame format; otherwise, loaded from state frame.

FPCR: Cleared if NULL frame format; otherwise, loaded from state frame.

FPIAR: Cleared if NULL frame format; otherwise unchanged.

FRESTORE

Restore Internal Floating-Point State

FRESTORE

Floating-point data registers: Set to NaNs if NULL frame format; otherwise, unaffected.

Instruction Format:	15	14	13	12	11	10	9	8	7	6	5	4	3	2	1	0
	1	1	1	1	0	0	1	1	0	1	Source Effective Address					
											Mode		Register			

Instruction field:

- Source Effective Address field—Specifies the addressing mode, <ea>y, for the state frame. Only modes in the following table can be used.

Addressing Mode	Mode	Register	Addressing Mode	Mode	Register
Dy	—	—	(xxx).W	—	—
Ay	—	—	(xxx).L	—	—
(Ay)	010	reg. number: Ay	# <data>	—	—
(Ay)+	—	—			
-(Ay)	—	—			
(d ₁₆ , Ay)	101	reg. number: Ay	(d ₁₆ , PC)	111	010
(d ₈ , Ay, Xi)	—	—	(d ₈ , PC, Xi)	—	—

FSAVE

Save Internal Floating-Point State

First appeared in ISA_A

FSAVE

Operation: If in Supervisor State
Then FPU Internal State → <ea>x
Else Privilege Violation Exception

Assembler syntax: FSAVE <ea>x

Attributes: Unsized

Description: After allowing completion of any floating-point operation in progress, FSAVE saves the FPU internal state in a frame at the effective address. After a save operation, FPCR is cleared and the FPU is in idle state until the next instruction executes. The first longword written to the state frame includes the format field data. Floating-point operations in progress when an FSAVE is encountered complete before FSAVE executes, which then creates an IDLE state frame if no exceptions occurred; otherwise, an EXCP state frame is created. State frames in [Table 8-2](#) apply.

Table 8-2. State Frames

State	Description
NULL	An FSAVE generating this state frame indicates the FPU state was not modified because the last processor reset or FRESTORE with a NULL state frame. This indicates that the programmer's model is in reset state, with NaNs in floating-point data registers and zeros in FPCR, FPSR, and FPIAR. Stores of the system registers, FSAVE, and FMOVE stores do not cause the FPU change from NULL to another state.
IDLE	An FSAVE that generates this state frame indicates the FPU finished in an idle condition and is without pending exceptions waiting for the initiation of the next instruction.
EXCP	An FSAVE generates this state frame if any FPSR[EXC] bits and corresponding FPCR exception enable bits are set. This state typically indicates the FPU encountered an exception while attempting to complete execution of a previous floating-point instruction.

FSAVE does not save FPU programming model registers. It can be used with FMOVE to perform a full context save of the FPU that includes floating-point data and system control registers. For a complete context save, first execute FSAVE to save the internal state, then execute the appropriate FMOVE to store the data registers. FPCR and FPSR are saved as part of the FSAVE state frame. Furthermore, FPCR is cleared at the end of the FSAVE, preventing further exceptions if the handler includes floating-point instructions.

FPSR: Not affected

FPCR: Cleared

Instruction Format:	15	14	13	12	11	10	9	8	7	6	5	4	3	2	1	0
	1	1	1	1	0	0	1	1	0	0	Destination Effective Address					
											Mode		Register			

Instruction field:

- Effective address field—Specifies the addressing mode, <ea>x for the state frame. Only modes in the following table can be used.

Addressing Mode	Mode	Register	Addressing Mode	Mode	Register
Dx	—	—	(xxx).W	—	—
Ax	—	—	(xxx).L	—	—
(Ax)	010	reg. number:Ax	# <data>	—	—
(Ax)+	—	—			
-(Ax)	—	—			
(d ₁₆ ,Ax)	101	reg. number:Ax	(d ₁₆ ,PC)	—	—
(d ₈ ,Ax,Xi)	—	—	(d ₈ ,PC,Xi)	—	—

HALT

Halt the CPU

First appeared in ISA_A

HALT

Operation: If Supervisor State
Then Halt the Processor Core
Else Privilege Violation Exception

Assembler Syntax: HALT

Attributes: Unsized

Description: The processor core is synchronized (meaning all previous instructions and bus cycles are completed) and then halts operation. The processor's halt status is signaled on the processor status output pins (PST=0xF). If a GO debug command is received, the processor resumes execution at the next instruction. Note that this instruction synchronizes the pipeline. The opcode for HALT is 0x4AC8.

Note that setting CSR[UHE] through the debug module allows HALT to be executed in user mode.

Condition Codes: Not affected

Instruction	15	14	13	12	11	10	9	8	7	6	5	4	3	2	1	0
Format:	0	1	0	0	1	0	1	0	1	1	0	0	1	0	0	0

INTOUCH

Instruction Fetch Touch

First appeared in ISA_B

INTOUCH

Operation: If Supervisor State
then Instruction Fetch Touch at (Ay)
else Privilege Violation Exception

Assembler Syntax: INTOUCH (Ay)

Attributes: Unsized

Description: Generates an instruction fetch reference at address (Ay). If the referenced address space is a cacheable region, this instruction can be used to prefetch a 16-byte packet into the processor's instruction cache. If the referenced instruction address is a non-cacheable space, the instruction effectively performs no operation. Note that this instruction synchronizes the pipeline.

The INTOUCH instruction can be used to prefetch, and with the later programming of CACR, lock specific memory lines in the processor's instruction cache. This function may be desirable in systems where deterministic real-time performance is critical.

Condition Codes: Not affected.

Instruction	15	14	13	12	11	10	9	8	7	6	5	4	3	2	1	0
Format:	1	1	1	1	0	1	0	0	0	0	1	0	1	Register, Ay		

Instruction Fields:

- Register field—Specifies the source address register, Ay.

MOVE from SR

Move from the Status Register

First appeared in ISA_A

MOVE from SR

Operation: If Supervisor State
Then SR → Destination
Else Privilege Violation Exception

Assembler Syntax: MOVE.W SR,Dx

Attributes: Size = word

Description: Moves the data in the status register to the destination location. The destination is word length. Unimplemented bits are read as zeros.

Condition Codes: Not affected

Instruction Format:	15	14	13	12	11	10	9	8	7	6	5	4	3	2	1	0
	0	1	0	0	0	0	0	0	1	1	0	0	0	Register, Dx		

Instruction Field:

- Register field—Specifies the destination data register, Dx.

MOVE from USP

Move from User Stack Pointer

First appeared in ISA_B

MOVE from USP

Operation: If Supervisor State
Then USP → Destination
Else Privilege Violation Exception

Assembler Syntax: MOVE.L USP,Ax

Attributes: Size = longword

Description: Moves the contents of the user stack pointer to the specified address register. If execution of this instruction is attempted on a processor implementing ISA_A, or on the MCF5407, an illegal instruction exception will be taken. For all processors, this instruction executes correctly if CACR[EUSP] is set.

Condition Codes: Not affected

Instruction	15	14	13	12	11	10	9	8	7	6	5	4	3	2	1	0
Format:	0	1	0	0	1	1	1	0	0	1	1	0	1	Register, Ax		

Instruction Field:

- Register field—Specifies the destination address register, Ax.

MOVE to SR

Move to the Status Register

First appeared in ISA_A

MOVE to SR

Operation: If Supervisor State
Then Source → SR
Else Privilege Violation Exception

Assembler Syntax: MOVE.W <ea>y,SR

Attributes: Size = word

Description: Moves the data in the source operand to the status register. The source operand is a word, and all implemented bits of the status register are affected. Note that this instruction synchronizes the pipeline.

Condition Codes:

X	N	Z	V	C
*	*	*	*	*

X Set to the value of bit 4 of the source operand
 N Set to the value of bit 3 of the source operand
 Z Set to the value of bit 2 of the source operand
 V Set to the value of bit 1 of the source operand
 C Set to the value of bit 0 of the source operand

Instruction Format:

15	14	13	12	11	10	9	8	7	6	5	4	3	2	1	0
0	1	0	0	0	1	1	0	1	1	Source Effective Address					
										Mode		Register			

Instruction Field:

- Effective Address field—Specifies the location of the source operand; use only those data addressing modes listed in the following table:

Addressing Mode	Mode	Register	Addressing Mode	Mode	Register
Dy	000	reg. number:Dy	(xxx).W	—	—
Ay	—	—	(xxx).L	—	—
(Ay)	—	—	#<data>	111	100
(Ay) +	—	—			
– (Ay)	—	—			
(d ₁₆ ,Ay)	—	—	(d ₁₆ ,PC)	—	—
(d ₈ ,Ay,Xi)	—	—	(d ₈ ,PC,Xi)	—	—

MOVE to USP

Move to User Stack Pointer

First appeared in ISA_B

MOVE to USP

Operation: If Supervisor State
Then Source → USP
Else Privilege Violation Exception

Assembler Syntax: MOVE.L Ay,USP

Attributes: Size = longword

Description: Moves the contents of an address register to the user stack pointer. If execution of this instruction is attempted on a processor implementing ISA_A, or on the MCF5407, an illegal instruction exception will be taken. For all processors, this instruction executes correctly if CACR[EUSP] is set.

Condition Codes: Not affected

Instruction Format:	15	14	13	12	11	10	9	8	7	6	5	4	3	2	1	0
	0	1	0	0	1	1	1	0	0	1	1	0	0	Register, Ay		

Instruction Field:

- Register field—Specifies the source address register, Ay.

MOVEC

Move Control Register

First appeared in ISA_A

MOVEC

Operation: If Supervisor State
Then $Ry \rightarrow Rc$
Else Privilege Violation Exception

Assembler Syntax: MOVEC.L Ry,Rc

Attributes: Size = longword

Description: Moves the contents of the general-purpose register to the specified control register. This transfer is always 32 bits even though the control register may be implemented with fewer bits. Note that the control registers are write only. The on-chip debug module can be used to read control registers. Note that this instruction synchronizes the pipeline.

Not all control registers are implemented in every ColdFire processor design. Refer to the user's manual for a specific device to find out which registers are implemented. Attempted access to undefined or unimplemented control register space produces undefined results.

Condition Codes: Not affected

Instruction Format:	15	14	13	12	11	10	9	8	7	6	5	4	3	2	1	0
	0	1	0	0	1	1	1	0	0	1	1	1	1	0	1	1
	A/D				Register, Ry				Control Register, Rc							

Instruction Fields:

- A/D field—Specifies the type of source register, Ry:
 - 0 data register
 - 1 address register
- Register Ry field—Specifies the source register, Ry.
- Control Register Rc field—Specifies the control register affected using the values shown in [Table 8-3](#).
-

Table 8-3. ColdFire CPU Space Assignments

Name	CPU Space Assignment	Register Name
Memory Management Control Registers		
CACR	0x002	Cache control register
ASID	0x003	Address space identifier register
ACR0	0x004	Access control registers 0
ACR1	0x005	Access control registers 1
ACR2	0x006	Access control registers 2
ACR3	0x007	Access control registers 3
MMUBAR	0x008	MMU base address register

Table 8-3. ColdFire CPU Space Assignments (Continued)

Name	CPU Space Assignment	Register Name
Processor Miscellaneous Registers		
VBR	0x801	Vector base register
PC	0x80F	Program counter
Local Memory and Module Control Registers		
ROMBAR0	0xC00	ROM base address register 0
ROMBAR1	0xC01	ROM base address register 1
RAMBAR0	0xC04	RAM base address register 0
RAMBAR1	0xC05	RAM base address register 1
MPCR	0xC0C	Multiprocessor control register ¹
EDRAMBAR	0xC0D	Embedded DRAM base address register ¹
SECMBAR	0xC0E	Secondary module base address register ¹
MBAR	0xC0F	Primary module base address register
Local Memory Address Permutation Control Registers ¹		
PCR1U0	0xD02	32 msbs of RAM 0 permutation control register 1
PCR1L0	0xD03	32 lsbs of RAM 0 permutation control register 1
PCR2U0	0xD04	32 msbs of RAM 0 permutation control register 2
PCR2L0	0xD05	32 lsbs of RAM 0 permutation control register 2
PCR3U0	0xD06	32 msbs of RAM 0 permutation control register 3
PCR3L0	0xD07	32 lsbs of RAM 0 permutation control register 3
PCR1U1	0xD0A	32 msbs of RAM 1 permutation control register 1
PCR1L1	0xD0B	32 lsbs of RAM 1 permutation control register 1
PCR2U1	0xD0C	32 msbs of RAM 1 permutation control register 2
PCR2L1	0xD0D	32 lsbs of RAM 1 permutation control register 2
PCR3U1	0xD0E	32 msbs of RAM 1 permutation control register 3
PCR3L1	0xD0F	32 lsbs of RAM 1 permutation control register 3

¹ Field definitions for these optional registers are implementation-specific.

RTE

Return from Exception

RTE

First appeared in ISA_A

Operation: If Supervisor State
Then $2 + (SP) \rightarrow SR$; $4 + (SP) \rightarrow PC$; $SP + 8 \rightarrow SP$
Adjust stack according to format
Else Privilege Violation Exception

Assembler Syntax: RTE

Attributes: Unsized

Description: Loads the processor state information stored in the exception stack frame located at the top of the stack into the processor. The instruction examines the stack format field in the format/offset word to determine how much information must be restored. Upon returning from exception, the processor is in user mode if $SR[S]=0$ when it is loaded from memory; otherwise, the processor remains in supervisor mode. Note that this instruction synchronizes the pipeline.

Condition Codes: Set according to the condition code bits in the status register value restored from the stack.

Instruction	15	14	13	12	11	10	9	8	7	6	5	4	3	2	1	0
Format:	0	1	0	0	1	1	1	0	0	1	1	1	0	0	1	1

STRLDSR

Store/Load Status Register

STRLDSR

First appeared in ISA_C

Operation: If Supervisor State
Then SP - 4 → SP; zero-filled SR → (SP); immediate data → SR
Else TRAP

Assembler Syntax: STRLDSR #<data>

Attributes: Size = word

Description: Pushes the contents of the Status Register onto the stack and then reloads the Status Register with the immediate data value. This instruction is intended for use as the first instruction of an interrupt service routine shared across multiple interrupt request levels. It allows the level of the just-taken interrupt request to be stored in memory (using the SR[IML] field), and then masks interrupts by loading the SR[IML] field with 0x7 (if desired). If execution is attempted with bit 13 of the immediate data cleared (attempting to place the processor in user mode), a privilege violation exception is generated. The opcode for STRLDSR is 0x40E7 46FC.

Condition	X	N	Z	V	C	X	Set to the value of bit 4 of the immediate operand
Codes:	*	*	*	*	*	N	Set to the value of bit 3 of the immediate operand
						Z	Set to the value of bit 2 of the immediate operand
						V	Set to the value of bit 1 of the immediate operand
						C	Set to the value of bit 0 of the immediate operand

Instruction	15	14	13	12	11	10	9	8	7	6	5	4	3	2	1	0
Format:	0	1	0	0	0	0	0	0	1	1	1	0	0	1	1	1
	0	1	0	0	0	1	1	0	1	1	1	1	1	1	0	0
	Immediate Data															

STOP

Load Status Register and Stop

STOP

First appeared in ISA_A

Operation: If Supervisor State
Then Immediate Data → SR; STOP
Else Privilege Violation Exception

Assembler Syntax: STOP #<data>

Attributes: Unsized

Description: Moves the immediate word operand into the status register (both user and supervisor portions), advances the program counter to point to the next instruction, and stops the fetching and executing of instructions. A trace, interrupt, or reset exception causes the processor to resume instruction execution. A trace exception occurs if instruction tracing is enabled (T0 = 1) when the STOP instruction begins execution, or if bit 15 of the immediate operand is a 1. If the bit of the immediate data corresponding to the S bit is cleared, execution of the instruction causes a privilege violation exception. If an interrupt request is asserted with a priority higher than the priority level set by the new status register value, an interrupt exception occurs; otherwise, the interrupt request is ignored. External reset always initiates reset exception processing. The STOP command places the processor in a low-power state. Note that this instruction synchronizes the pipeline. The opcode for STOP is 0x4E72, followed by the immediate data.

Condition Codes:	X	N	Z	V	C	X	Set to the value of bit 4 of the immediate data
	*	*	*	*	*	N	Set to the value of bit 3 of the immediate data
						Z	Set to the value of bit 2 of the immediate data
						V	Set to the value of bit 1 of the immediate data
						C	Set to the value of bit 0 of the immediate data

Instruction Format:	15	14	13	12	11	10	9	8	7	6	5	4	3	2	1	0
	0	1	0	0	1	1	1	0	0	1	1	1	0	0	1	0
	Immediate Data															

Instruction Field:

- Immediate Data field—Specifies the data to be loaded into the status register.

WDEBUG

Write Debug Control Register

WDEBUG

First appeared in ISA_A

Operation: If Supervisor State
 Then Write Control Register Command Executed in Debug Module
 Else Privilege Violation Exception

Assembler Syntax: WDEBUG.L <ea>y

Attributes: Size = longword

Description: Fetches two consecutive longwords from the memory location defined by the effective address. These operands are used by the ColdFire debug module to write one of the debug control registers (DRc). Note that this instruction synchronizes the pipeline. The memory location defined by the effective address must be longword aligned; otherwise undefined operation results. The debug command must be organized in memory as shown on the next page.

Condition Codes: Not affected

Instruction Format:

15	14	13	12	11	10	9	8	7	6	5	4	3	2	1	0
1	1	1	1	1	0	1	1	1	1	Source Effective Address					
										Mode		Register			
0	0	0	0	0	0	0	0	0	0	0	0	0	0	1	1

Instruction Field:

- Source Effective Address field—Specifies the address, <ea>y, for the operation; use only the addressing modes listed in the following table:

Addressing Mode	Mode	Register	Addressing Mode	Mode	Register
Dy	—	—	(xxx).W	—	—
Ay	—	—	(xxx).L	—	—
(Ay)	010	reg. number: Ay	#<data>	—	—
(Ay) +	—	—			
– (Ay)	—	—			
(d ₁₆ ,Ay)	101	reg. number: Ay	(d ₁₆ ,PC)	—	—
(d ₈ ,Ay,Xi)	—	—	(d ₈ ,PC,Xi)	—	—

WDEBUG

Write Debug Control Register

WDEBUG

Debug Command Organization in Memory:

15	14	13	12	11	10	9	8	7	6	5	4	3	2	1	0
0	0	1	0	1	1	0	0	1	0	0	DRc				
Data[31:16]															
Data[15:0]															
Unused															

where:

- Bits [15:4] of the first word define the WDREG command to the debug module.
- Bits [3:0] of the first word define the specific control register, DRc, to write. The table below contains DRc definitions. Note that some cores implement a subset of the debug registers. Refer to a specific device or core user's manual for more information.

DRc[4-0]	Register Name	DRc[4-0]	Register Name
0x00	Configuration/status register	0x10-0x1	Reserved
0x01-0x0	Reserved	0x14	PC breakpoint ASID register
0x04	PC breakpoint ASID control	0x15	Reserved
0x05	BDM address attribute register	0x16	Address attribute trigger register 1
0x06	Address attribute trigger register	0x17	Extended trigger definition register
0x07	Trigger definition register	0x18	Program counter breakpoint 1 register
0x08	Program counter breakpoint register	0x19	Reserved
0x09	Program counter breakpoint mask register	0x1A	Program counter breakpoint register 2
0x0A-0x0B	Reserved	0x1B	Program counter breakpoint register 3
0x0C	Address breakpoint high register	0x1C	Address high breakpoint register 1
0x0D	Address breakpoint low register	0x1D	Address low breakpoint register 1
0x0E	Data breakpoint register	0x1E	Data breakpoint register 1
0x0F	Data breakpoint mask register	0x1F	Data breakpoint mask register 1

- Data[31:0] is the 32-bit operand to be written.
- The fourth word is unused.



THIS PAGE INTENTIONALLY LEFT BLANK

Chapter 9

Instruction Format Summary

This chapter contains a numerical listing of the ColdFire family instructions in binary format. Wherever the binary encoding for an entire nibble of an instruction is predefined, the hex value for that nibble appears on the right side of the page, otherwise a dash (—) is used to show that it is variable.

9.1 Operation Code Map

Table 9-1 lists the encoding for bits 15–12 and the operation performed.

Table 9-1. Operation Code Map

Bits 15–12	Hex	Operation
0000	0	Bit Manipulation/Immediate
0001	1	Move Byte
0010	2	Move Longword
0011	3	Move Word
0100	4	Miscellaneous
0101	5	ADDQ/SUBQ/ScC/TPF
0110	6	Bcc/BSR/BRA
0111	7	MOVEQ/MVS/MVZ
1000	8	OR/DIV
1001	9	SUB/SUBX
1010	A	MAC/EMAC instructions/MOV3Q
1011	B	CMP/EOR
1100	C	AND/MUL
1101	D	ADD/ADDX
1110	E	Shift
1111	F	Floating-Point/Debug/Cache Instructions

ORI

0x008—

15	14	13	12	11	10	9	8	7	6	5	4	3	2	1	0
0	0	0	0	0	0	0	0	1	0	0	0	0	Register, Dx		
Upper Word of Immediate Data															
Lower Word of Immediate Data															

BITREV**0x00C-**

15	14	13	12	11	10	9	8	7	6	5	4	3	2	1	0
0	0	0	0	0	0	0	0	1	1	0	0	0	Register, Dx		
Upper Word of Immediate Data															
Lower Word of Immediate Data															

BTST**0x0—**

Bit number dynamic, specified in a register

15	14	13	12	11	10	9	8	7	6	5	4	3	2	1	0
0	0	0	0	Data Register, Dy		1	0	0	Destination Effective Address						
										Mode		Register			

BCHG**0x0—**

Bit number dynamic, specified in a register

15	14	13	12	11	10	9	8	7	6	5	4	3	2	1	0
0	0	0	0	Data Register, Dy		1	0	1	Destination Effective Address						
										Mode		Register			

BCLR**0x0—**

Bit number dynamic, specified in a register

15	14	13	12	11	10	9	8	7	6	5	4	3	2	1	0
0	0	0	0	Data Register, Dy		1	1	0	Destination Effective Address						
										Mode		Register			

BSET**0x0—**

Bit number dynamic, specified in a register

15	14	13	12	11	10	9	8	7	6	5	4	3	2	1	0
0	0	0	0	Data Register, Dy		1	1	1	Destination Effective Address						
										Mode		Register			

ANDI**0x028-**

15	14	13	12	11	10	9	8	7	6	5	4	3	2	1	0
0	0	0	0	0	0	1	0	1	0	0	0	0	Register, Dx		
Upper Word of Immediate Data															
Lower Word of Immediate Data															

BYTEREV**0x02C-**

15	14	13	12	11	10	9	8	7	6	5	4	3	2	1	0
0	0	0	0	0	0	1	0	1	1	0	0	0	Register, Dx		
Upper Word of Immediate Data															
Lower Word of Immediate Data															

SUBI**0x048-**

15	14	13	12	11	10	9	8	7	6	5	4	3	2	1	0
0	0	0	0	0	1	0	0	1	0	0	0	0	Register, Dx		
Upper Word of Immediate Data															
Lower Word of Immediate Data															

FF1**0x04C-**

15	14	13	12	11	10	9	8	7	6	5	4	3	2	1	0
0	0	0	0	0	1	0	0	1	1	0	0	0	Register, Dx		
Upper Word of Immediate Data															
Lower Word of Immediate Data															

ADDI**0x068-**

15	14	13	12	11	10	9	8	7	6	5	4	3	2	1	0
0	0	0	0	0	1	1	0	1	0	0	0	0	Register, Dx		
Upper Word of Immediate Data															
Lower Word of Immediate Data															

BTST**0x08— 00—**

Bit number static, specified as immediate data

15	14	13	12	11	10	9	8	7	6	5	4	3	2	1	0
0	0	0	0	1	0	0	0	0	0	Destination Effective Address					
										Mode		Register			
0	0	0	0	0	0	0	0	Bit Number							

BCHG**0x08— 00—**

Bit number static, specified as immediate data

15	14	13	12	11	10	9	8	7	6	5	4	3	2	1	0
0	0	0	0	1	0	0	0	0	1	Destination Effective Address					
										Mode		Register			
0	0	0	0	0	0	0	0	Bit Number							

BCLR**0x08— 00—**

Bit number static, specified as immediate data

15	14	13	12	11	10	9	8	7	6	5	4	3	2	1	0
0	0	0	0	1	0	0	0	1	0	Destination Effective Address					
								Mode		Register					
0	0	0	0	0	0	0	0	Bit Number							

BSET**0x08— 00—**

Bit number static, specified as immediate data

15	14	13	12	11	10	9	8	7	6	5	4	3	2	1	0
0	0	0	0	1	0	0	0	1	1	Destination Effective Address					
								Mode		Register					
0	0	0	0	0	0	0	0	Bit Number							

EORI**0x0A8—**

15	14	13	12	11	10	9	8	7	6	5	4	3	2	1	0
0	0	0	0	1	0	1	0	1	0	0	0	0	Register, Dx		
Upper Word of Immediate Data															
Lower Word of Immediate Data															

CMPI**0x0C—**

15	14	13	12	11	10	9	8	7	6	5	4	3	2	1	0
0	0	0	0	1	1	0	0	Size		0	0	0	Register, Dx		
Upper Word of Immediate Data															
Lower Word of Immediate Data															

MOVE**0x—**

15	14	13	12	11	10	9	8	7	6	5	4	3	2	1	0
0	0	Size		Destination Effective Address				Source Effective Address							
				Register		Mode		Mode		Register					

STLDSR**0x40E7—**

15	14	13	12	11	10	9	8	7	6	5	4	3	2	1	0
0	1	0	0	0	0	0	0	1	1	1	0	0	1	1	1
0	1	0	0	0	1	1	0	1	1	1	1	1	1	0	0
<Immediate Data>															

MOVEA**0x——**

15	14	13	12	11	10	9	8	7	6	5	4	3	2	1	0
0	0	Size		Destination Register, Ax		0	0	1	Source Effective Address						
								Mode		Register					

NEGX**0x408-**

15	14	13	12	11	10	9	8	7	6	5	4	3	2	1	0
0	1	0	0	0	0	0	0	1	0	0	0	0	Register, Dx		

MOVE from SR**0x40C-**

15	14	13	12	11	10	9	8	7	6	5	4	3	2	1	0
0	1	0	0	0	0	0	0	1	1	0	0	0	Register, Dx		

LEA**0x4——**

15	14	13	12	11	10	9	8	7	6	5	4	3	2	1	0
0	1	0	0	Register, Ax		1	1	1	Source Effective Address						
								Mode		Register					

CLR**0x42——**

15	14	13	12	11	10	9	8	7	6	5	4	3	2	1	0
0	1	0	0	0	0	1	0	Size		Destination Effective Address					
								Mode		Register					

MOVE from CCR**0x42C-**

15	14	13	12	11	10	9	8	7	6	5	4	3	2	1	0
0	1	0	0	0	0	1	0	1	1	0	0	0	Register, Dx		

NEG**0x448-**

15	14	13	12	11	10	9	8	7	6	5	4	3	2	1	0
0	1	0	0	0	1	0	0	1	0	0	0	0	Register, Dx		

MOVE to CCR**0x44——**

15	14	13	12	11	10	9	8	7	6	5	4	3	2	1	0
0	1	0	0	0	1	0	0	1	1	Source Effective Address					
								Mode		Register					

NOT**0x468-**

15	14	13	12	11	10	9	8	7	6	5	4	3	2	1	0
0	1	0	0	0	1	1	0	1	0	0	0	0	Register, Dx		

MOVE to SR**0x46—**

15	14	13	12	11	10	9	8	7	6	5	4	3	2	1	0
0	1	0	0	0	1	1	0	1	1	Source Effective Address					
										Mode		Register			

SWAP**0x484—**

15	14	13	12	11	10	9	8	7	6	5	4	3	2	1	0
0	1	0	0	1	0	0	0	0	1	0	0	0	Register, Dx		

PEA**0x48—**

15	14	13	12	11	10	9	8	7	6	5	4	3	2	1	0
0	1	0	0	1	0	0	0	0	1	Source Effective Address					
										Mode		Register			

EXT, EXTB**0x4—**

15	14	13	12	11	10	9	8	7	6	5	4	3	2	1	0
0	1	0	0	1	0	0	Opmode			0	0	0	Register, Dx		

MOVEM**0x4—**

15	14	13	12	11	10	9	8	7	6	5	4	3	2	1	0
0	1	0	0	1	dr	0	0	1	1	Effective Address					
										Mode		Register			
Register List Mask															

TST**0x4A—**

15	14	13	12	11	10	9	8	7	6	5	4	3	2	1	0
0	1	0	0	1	0	1	0	Size		Destination Effective Address					
										Mode		Register			

TAS**0x4A—**

15	14	13	12	11	10	9	8	7	6	5	4	3	2	1	0
0	1	0	0	1	0	1	0	1	1	Destination Effective Address					
										Mode		Register			

HALT**0x4AC8**

15	14	13	12	11	10	9	8	7	6	5	4	3	2	1	0
0	1	0	0	1	0	1	0	1	1	0	0	1	0	0	0

PULSE

0x4ACC

15	14	13	12	11	10	9	8	7	6	5	4	3	2	1	0
0	1	0	0	1	0	1	0	1	1	0	0	1	1	0	0

ILLEGAL

0x4AFC

15	14	13	12	11	10	9	8	7	6	5	4	3	2	1	0
0	1	0	0	1	0	1	0	1	1	1	1	1	1	0	0

MULU.L

0x4C— –000

15	14	13	12	11	10	9	8	7	6	5	4	3	2	1	0
0	1	0	0	1	1	0	0	0	0	Source Effective Address					
										Mode		Register			
0	Register, Dx			0	0	0	0	0	0	0	0	0	0	0	0

MULS.L

0x4C— –800

15	14	13	12	11	10	9	8	7	6	5	4	3	2	1	0
0	1	0	0	1	1	0	0	0	0	Source Effective Address					
										Mode		Register			
0	Register, Dx			1	0	0	0	0	0	0	0	0	0	0	0

DIVU.L

0x4C— –00–

15	14	13	12	11	10	9	8	7	6	5	4	3	2	1	0
0	1	0	0	1	1	0	0	0	1	Source Effective Address					
										Mode		Register			
0	Register, Dx			0	0	0	0	0	0	0	0	0	Register, Dx		

REMU.L

0x4C— –00–

15	14	13	12	11	10	9	8	7	6	5	4	3	2	1	0
0	1	0	0	1	1	0	0	0	1	Source Effective Address					
										Mode		Register			
0	Register, Dx			0	0	0	0	0	0	0	0	0	Register, Dw		

DIVS.L

0x4C— –80–

15	14	13	12	11	10	9	8	7	6	5	4	3	2	1	0
0	1	0	0	1	1	0	0	0	1	Source Effective Address					
										Mode		Register			
0	Register, Dx			1	0	0	0	0	0	0	0	0	Register, Dx		

REMS.L**0x4C— –80–**

15	14	13	12	11	10	9	8	7	6	5	4	3	2	1	0
0	1	0	0	1	1	0	0	0	1	Source Effective Address					
								Mode				Register			
0	Register, Dx			1	0	0	0	0	0	0	0	0	Register, Dw		

SATS**0x4C8–**

15	14	13	12	11	10	9	8	7	6	5	4	3	2	1	0
0	1	0	0	1	1	0	0	1	0	0	0	0	Register, Dx		

TRAP**0x4E4–**

15	14	13	12	11	10	9	8	7	6	5	4	3	2	1	0
0	1	0	0	1	1	1	0	0	1	0	0	Vector			

LINK**0x4E5–**

15	14	13	12	11	10	9	8	7	6	5	4	3	2	1	0
0	1	0	0	1	1	1	0	0	1	0	1	0	Register, Ay		
Word Displacement															

UNLK**0x4E5–**

15	14	13	12	11	10	9	8	7	6	5	4	3	2	1	0
0	1	0	0	1	1	1	0	0	1	0	1	1	Register, Ax		

MOVE to USP**0x4E6–**

15	14	13	12	11	10	9	8	7	6	5	4	3	2	1	0
0	1	0	0	1	1	1	0	0	1	1	0	0	Register, Ay		

MOVE from USP**0x4E6–**

15	14	13	12	11	10	9	8	7	6	5	4	3	2	1	0
0	1	0	0	1	1	1	0	0	1	1	0	1	Register, Ax		

NOP**0x4E71**

15	14	13	12	11	10	9	8	7	6	5	4	3	2	1	0
0	1	0	0	1	1	1	0	0	1	1	1	0	0	0	1

STOP**0x4E72**

15	14	13	12	11	10	9	8	7	6	5	4	3	2	1	0
0	1	0	0	1	1	1	0	0	1	1	1	0	0	1	0
Immediate Data															

RTE**0x4E73**

15	14	13	12	11	10	9	8	7	6	5	4	3	2	1	0
0	1	0	0	1	1	1	0	0	1	1	1	0	0	1	1

RTS**0x4E75**

15	14	13	12	11	10	9	8	7	6	5	4	3	2	1	0
0	1	0	0	1	1	1	0	0	1	1	1	0	1	0	1

MOVEC**0x4E7B**

15	14	13	12	11	10	9	8	7	6	5	4	3	2	1	0
0	1	0	0	1	1	1	0	0	1	1	1	1	0	1	1
D/A	Register, Ry			Control Register, Rc											

JSR**0x4E—**

15	14	13	12	11	10	9	8	7	6	5	4	3	2	1	0
0	1	0	0	1	1	1	0	1	0	Source Effective Address					
										Mode		Register			

JMP**0x4E—**

15	14	13	12	11	10	9	8	7	6	5	4	3	2	1	0
0	1	0	0	1	1	1	0	1	1	Source Effective Address					
										Mode		Register			

ADDQ**0x5—**

15	14	13	12	11	10	9	8	7	6	5	4	3	2	1	0
0	1	0	1	Data			0	1	0	Destination Effective Address					
										Mode		Register			

Scc**0x5-C-**

15	14	13	12	11	10	9	8	7	6	5	4	3	2	1	0	
0	1	0	1	Condition				1	1	0	0	0	Register, Dx			

SUBQ**0x5—**

15	14	13	12	11	10	9	8	7	6	5	4	3	2	1	0
0	1	0	1	Data			1	1	0	Destination Effective Address					
										Mode		Register			

TPF**0x51F—**

15	14	13	12	11	10	9	8	7	6	5	4	3	2	1	0
0	1	0	1	0	0	0	1	1	1	1	1	1	Opmode		
Optional Immediate Word															
Optional Immediate Word															

BRA**0x60—**

15	14	13	12	11	10	9	8	7	6	5	4	3	2	1	0
0	1	1	0	0	0	0	0	8-bit displacement							
16-bit displacement if 8-bit displacement = 0x00															
32-bit displacement if 8-bit displacement = 0xFF															

BSR**0x61—**

15	14	13	12	11	10	9	8	7	6	5	4	3	2	1	0
0	1	1	0	0	0	0	1	8-bit displacement							
16-bit displacement if 8-bit displacement = 0x00															
32-bit displacement if 8-bit displacement = 0xFF															

Bcc**0x6—**

15	14	13	12	11	10	9	8	7	6	5	4	3	2	1	0	
0	1	1	0	Condition				8-bit displacement								
16-bit displacement if 8-bit displacement = 0x00																
32-bit displacement if 8-bit displacement = 0xFF																

MOVEQ**0x7—**

15	14	13	12	11	10	9	8	7	6	5	4	3	2	1	0	
0	1	1	1	Register, Dx			0	Immediate Data								

MVS**0x7—**

15	14	13	12	11	10	9	8	7	6	5	4	3	2	1	0	
0	1	1	1	Register, Dx			1	0	Size	Source Effective Address						
								Mode				Register				

MVZ**0x7—**

15	14	13	12	11	10	9	8	7	6	5	4	3	2	1	0	
0	1	1	1	Register, Dx			1	1	Size	Source Effective Address						
								Mode				Register				

OR

0x8—

15	14	13	12	11	10	9	8	7	6	5	4	3	2	1	0
1	0	0	0	Register				Opmode				Effective Address			
								Mode				Register			

DIVU.W

0x8—

15	14	13	12	11	10	9	8	7	6	5	4	3	2	1	0
1	0	0	0	Register, Dx				0	1	1	Source Effective Address				
								Mode				Register			

DIVS.W

0x8—

15	14	13	12	11	10	9	8	7	6	5	4	3	2	1	0
1	0	0	0	Register, Dx				1	1	1	Source Effective Address				
								Mode				Register			

SUB

0x9—

15	14	13	12	11	10	9	8	7	6	5	4	3	2	1	0
1	0	0	1	Register				Opmode				Effective Address			
								Mode				Register			

SUBX

0x9—

15	14	13	12	11	10	9	8	7	6	5	4	3	2	1	0		
1	0	0	1	Register, Dx				1	1	0	0	0	0	Register, Dy			

SUBA

0x9—

15	14	13	12	11	10	9	8	7	6	5	4	3	2	1	0
1	0	0	1	Destination Register, Ax				1	1	1	Source Effective Address				
								Mode				Register			

MAC (MAC)

0xA—

15	14	13	12	11	10	9	8	7	6	5	4	3	2	1	0	
1	0	1	0	Register, Rx				0	0	Rx	0	0	Register, Ry			
—	—	—	—	sz	Scale Factor			0	U/Lx	U/Ly	—	0	—	—	0	0

MAC (EMAC)**0xA——**

15	14	13	12	11	10	9	8	7	6	5	4	3	2	1	0
1	0	1	0	Register, Rx			0	ACC lsb	Rx msb	0	0	Register, Ry			
—	—	—	—	sz	Scale Factor		0	U/Lx	U/Ly	—	ACC msb	—	—	0	0

MAC with load (MAC)**0xA——**

15	14	13	12	11	10	9	8	7	6	5	4	3	2	1	0
1	0	1	0	Register, Rw			0	1	Rw	Source Effective Address					
										Mode		Register			
Register, Rx				sz	Scale Factor		0	U/Lx	U/Ly	Mask	0	Register, Ry			

MAC with load (EMAC)**0xA——**

15	14	13	12	11	10	9	8	7	6	5	4	3	2	1	0
1	0	1	0	Register, Rw			0	ACC lsb	Rw	Source Effective Address					
										Mode		Register			
Register, Rx				sz	Scale Factor		0	U/Lx	U/Ly	Mask	ACC msb	Register, Ry			

MAAAC (EMAC_B)**0xA——**

15	14	13	12	11	10	9	8	7	6	5	4	3	2	1	0
1	0	1	0	Register, Rx			0	ACC lsb	Rx msb	0	0	Register, Ry			
—	—	—	—	sz	Scale Factor		0	U/Lx	U/Ly	—	ACC msb	ACCw	0	1	

MSAAC (EMAC_B)**0xA——**

15	14	13	12	11	10	9	8	7	6	5	4	3	2	1	0
1	0	1	0	Register, Rx			0	ACC lsb	Rx msb	0	0	Register, Ry			
—	—	—	—	sz	Scale Factor		0	U/Lx	U/Ly	—	ACC msb	ACCw	1	1	

MSAC (MAC)**0xA——**

15	14	13	12	11	10	9	8	7	6	5	4	3	2	1	0
1	0	1	0	Register, Rx			0	0	Rx	0	0	Register, Ry			
—	—	—	—	sz	Scale Factor		1	U/Lx	U/Ly	—	0	—	—	0	0

MSAC (EMAC)

0xA—

15	14	13	12	11	10	9	8	7	6	5	4	3	2	1	0
1	0	1	0	Register, Rx			0	ACC lsb	Rx msb	0	0	Register, Ry			
—	—	—	—	sz	Scale Factor		1	U/Lx	U/Ly	—	ACC msb	—	—	0	0

MSAC with load (MAC)

0xA—

15	14	13	12	11	10	9	8	7	6	5	4	3	2	1	0
1	0	1	0	Register, Rw			0	1	Rw	Source Effective Address					
										Mode		Register			
Register, Rx				sz	Scale Factor		1	U/Lx	U/Ly	Mask	0	Register, Ry			

MSAC with load (EMAC)

0xA—

15	14	13	12	11	10	9	8	7	6	5	4	3	2	1	0
1	0	1	0	Register, Rw			0	ACC lsb	Rw	Source Effective Address					
										Mode		Register			
Register, Rx				sz	Scale Factor		1	U/Lx	U/Ly	Mask	ACC msb	Register, Ry			

MSAAC (EMAC_B)

0xA—

15	14	13	12	11	10	9	8	7	6	5	4	3	2	1	0
1	0	1	0	Register, Rx			0	ACC lsb	Rx msb	0	0	Register, Ry			
—	—	—	—	sz	Scale Factor		1	U/Lx	U/Ly	—	ACC msb	ACCw	0	1	

MSSAC (EMAC_B) (WRONG VMA)

0xA—

15	14	13	12	11	10	9	8	7	6	5	4	3	2	1	0
1	0	1	0	Register, Rx			0	ACC lsb	Rx msb	0	0	Register, Ry			
—	—	—	—	sz	Scale Factor		1	U/Lx	U/Ly	—	ACC msb	ACCw	1	1	

MOVE to ACC (MAC)

0xA1—

15	14	13	12	11	10	9	8	7	6	5	4	3	2	1	0
1	0	1	0	0	0	0	1	0	0	Source Effective Address					
										Mode		Register			

MOVE to ACC (EMAC)**0xA—**

15	14	13	12	11	10	9	8	7	6	5	4	3	2	1	0
1	0	1	0	0	ACC	1	0	0	Source Effective Address						
										Mode		Register			

MOVE ACC to ACC (EMAC)**0xA-1-**

15	14	13	12	11	10	9	8	7	6	5	4	3	2	1	0
1	0	1	0	0	ACCx	1	0	0	0	0	1	0	0	ACCy	

MOVE from ACC (MAC)**0xA18-**

15	14	13	12	11	10	9	8	7	6	5	4	3	2	1	0
1	0	1	0	0	0	0	1	1	0	0	0	Register, Rx			

MOVE from ACC (EMAC)**0xA-8-**

15	14	13	12	11	10	9	8	7	6	5	4	3	2	1	0
1	0	1	0	0	ACC	1	1	0	0	0	Register, Rx				

MOVCLR (EMAC)**0xA-C-**

15	14	13	12	11	10	9	8	7	6	5	4	3	2	1	0
1	0	1	0	0	ACC	1	1	1	0	0	Register, Rx				

MOVE from MACSR**0xA98-**

15	14	13	12	11	10	9	8	7	6	5	4	3	2	1	0
1	0	1	0	1	0	0	1	1	0	0	0	Register, Rx			

MOVE to MACSR**0xA9—**

15	14	13	12	11	10	9	8	7	6	5	4	3	2	1	0
1	0	1	0	1	0	0	1	0	0	Source Effective Address					
										Mode		Register			

MOVE from MACSR to CCR**0xA9C0**

15	14	13	12	11	10	9	8	7	6	5	4	3	2	1	0
1	0	1	0	1	0	0	1	1	1	0	0	0	0	0	0

MOVE to ACCext01 (EMAC)**0xAB—**

15	14	13	12	11	10	9	8	7	6	5	4	3	2	1	0
1	0	1	0	1	0	1	1	0	0	Source Effective Address					
										Mode		Register			

MOVE from ACCext01 (EMAC)**0xAB8—**

15	14	13	12	11	10	9	8	7	6	5	4	3	2	1	0
1	0	1	0	1	0	1	1	1	0	0	0	Register, Rx			

MOVE to MASK**0xAD—**

15	14	13	12	11	10	9	8	7	6	5	4	3	2	1	0
1	0	1	0	1	1	0	1	0	0	Source Effective Address					
										Mode		Register			

MOVE from MASK**0xAD8—**

15	14	13	12	11	10	9	8	7	6	5	4	3	2	1	0
1	0	1	0	1	1	0	1	1	0	0	0	Register, Rx			

MOVE to ACCext23 (EMAC)**0xAF—**

15	14	13	12	11	10	9	8	7	6	5	4	3	2	1	0
1	0	1	0	1	1	1	1	0	0	Source Effective Address					
										Mode		Register			

MOVE from ACCext23 (EMAC)**0xAF8—**

15	14	13	12	11	10	9	8	7	6	5	4	3	2	1	0
1	0	1	0	1	1	1	1	1	0	0	0	Register, Rx			

MOV3Q**0xA—**

15	14	13	12	11	10	9	8	7	6	5	4	3	2	1	0
1	0	1	0	Immediate Data			1	0	1	Destination Effective Address					
										Mode		Register			

CMP**0xB—**

15	14	13	12	11	10	9	8	7	6	5	4	3	2	1	0
1	0	1	1	Register, Dx			Opcode			Source Effective Address					
										Mode		Register			

CMPA**0xB—**

15	14	13	12	11	10	9	8	7	6	5	4	3	2	1	0
1	0	1	1	Destination Register, Ax			Opcode			Source Effective Address					
										Mode		Register			

EOR**0xB—**

15	14	13	12	11	10	9	8	7	6	5	4	3	2	1	0	
1	0	1	1	Register, Dy				1	1	0	Destination Effective Address					
										Mode		Register				

AND**0xC—**

15	14	13	12	11	10	9	8	7	6	5	4	3	2	1	0	
1	1	0	0	Data Register				Opmode				Effective Address				
										Mode		Register				

MULU.W**0xC—**

15	14	13	12	11	10	9	8	7	6	5	4	3	2	1	0	
1	1	0	0	Register, Dx				0	1	1	Source Effective Address					
										Mode		Register				

MULS.W**0xC—**

15	14	13	12	11	10	9	8	7	6	5	4	3	2	1	0	
1	1	0	0	Register, Dx				1	1	1	Source Effective Address					
										Mode		Register				

ADD**0xD—**

15	14	13	12	11	10	9	8	7	6	5	4	3	2	1	0	
1	1	0	1	Register				Opmode				Effective Address				
										Mode		Register				

ADDX**0xD-8-**

15	14	13	12	11	10	9	8	7	6	5	4	3	2	1	0	
1	1	0	1	Register, Dx				1	1	0	0	0	0	Register, Dy		

ADDA**0xD—**

15	14	13	12	11	10	9	8	7	6	5	4	3	2	1	0	
1	1	0	1	Destination Register, Ax				1	1	1	Source Effective Address					
										Mode		Register				

ASL, ASR**0xE—**

15	14	13	12	11	10	9	8	7	6	5	4	3	2	1	0	
1	1	1	0	Count or Register, Dy				dr	1	0	i/r	0	0	Register, Dx		

LSL, LSR**0xE—**

15	14	13	12	11	10	9	8	7	6	5	4	3	2	1	0	
1	1	1	0	Count or Register, Dy				dr	1	0	i/r	0	1	Register, Dx		

FMOVE**0xF2—**

Memory- and register-to-register operation (<ea>y,FPx; FPy,FPx)

15	14	13	12	11	10	9	8	7	6	5	4	3	2	1	0	
1	1	1	1	0	0	1	0	0	0	Source Effective Address				Register		
Mode		Register														
0	R/M	0	Source Specifier			Destination Register, FPx			Opmode (0000000, 1000000, or 1000100)							

FMOVE**0xF2— —0**

Register-to-memory operation (FPy,<ea>x)

15	14	13	12	11	10	9	8	7	6	5	4	3	2	1	0	
1	1	1	1	0	0	1	0	0	0	Destination Effective Address				Register		
Mode		Register														
0	1	1	Destination Format			Source Register, FPy			0	0	0	0	0	0	0	

FINT**0xF2— —1**

15	14	13	12	11	10	9	8	7	6	5	4	3	2	1	0	
1	1	1	1	0	0	1	0	0	0	Source Effective Address				Register		
Mode		Register														
0	R/M	0	Source Specifier			Destination Register, FPx			0	0	0	0	0	0	1	

FINTRZ**0xF2— —3**

15	14	13	12	11	10	9	8	7	6	5	4	3	2	1	0	
1	1	1	1	0	0	1	0	0	0	Source Effective Address				Register		
Mode		Register														
0	R/M	0	Source Specifier			Destination Register, FPx			0	0	0	0	0	1	1	

FSQRT**0xF2—**

15	14	13	12	11	10	9	8	7	6	5	4	3	2	1	0	
1	1	1	1	0	0	1	0	0	0	Source Effective Address				Register		
Mode		Register														
0	R/M	0	Source Specifier			Destination Register, FPx			Opmode (0000100, 1000001, or 1000101)							

FABS**0xF2—**

15	14	13	12	11	10	9	8	7	6	5	4	3	2	1	0	
1	1	1	1	0	0	1	0	0	0	Source Effective Address						
				Mode				Register								
0	R/M	0	Source Specifier				Destination Register, FPx				Opmode (0011000, 1011000, or 1011100)					

FNEG**0xF2—**

15	14	13	12	11	10	9	8	7	6	5	4	3	2	1	0	
1	1	1	1	0	0	1	0	0	0	Source Effective Address						
				Mode				Register								
0	R/M	0	Source Specifier				Destination Register, FPx				Opmode (0011010, 1011010, or 1011110)					

FDIV**0xF2—**

15	14	13	12	11	10	9	8	7	6	5	4	3	2	1	0	
1	1	1	1	0	0	1	0	0	0	Source Effective Address						
				Mode				Register								
0	R/M	0	Source Specifier				Destination Register, FPx				Opmode (0100000, 1100000, or 1100100)					

FADD**0xF2—**

15	14	13	12	11	10	9	8	7	6	5	4	3	2	1	0	
1	1	1	1	0	0	1	0	0	0	Source Effective Address						
				Mode				Register								
0	R/M	0	Source Specifier				Destination Register, FPx				Opmode (0100010, 1100010, or 1100110)					

FMUL**0xF2—**

15	14	13	12	11	10	9	8	7	6	5	4	3	2	1	0	
1	1	1	1	0	0	1	0	0	0	Source Effective Address						
				Mode				Register								
0	R/M	0	Source Specifier				Destination Register, FPx				Opmode (0100011, 1100011, or 1100111)					

FSUB**0xF2—**

15	14	13	12	11	10	9	8	7	6	5	4	3	2	1	0
1	1	1	1	0	0	1	0	0	0	Source Effective Address					
										Mode		Register			
0	R/M	0	Source Specifier			Destination Register, FPx			Opmode (0101000, 1101000, or 1101100)						

FCMP**0xF2— —8**

15	14	13	12	11	10	9	8	7	6	5	4	3	2	1	0
1	1	1	1	0	0	1	0	0	0	Source Effective Address					
										Mode		Register			
0	R/M	0	Source Specifier			Destination Register, FPx			0	1	1	1	0	0	0

FTST**0xF2— —A**

15	14	13	12	11	10	9	8	7	6	5	4	3	2	1	0
1	1	1	1	0	0	1	0	0	0	Source Effective Address					
										Mode		Register			
0	R/M	0	Source Specifier			Destination Register, FPx			0	1	1	1	0	1	0

FBcc**0xF2—**

15	14	13	12	11	10	9	8	7	6	5	4	3	2	1	0
1	1	1	1	0	0	1	0	1	Size	Conditional Predicate					
16-bit displacement or most significant word of 32-bit displacement															
Least significant word of 32-bit displacement (if needed)															

FMOVE to FPIAR**0xF2— 8400**

15	14	13	12	11	10	9	8	7	6	5	4	3	2	1	0
1	1	1	1	0	0	1	0	0	0	Source Effective Address					
										Mode		Register			
1	0	0	0	0	1	0	0	0	0	0	0	0	0	0	0

FMOVE to FPSR**0xF2— 8800**

15	14	13	12	11	10	9	8	7	6	5	4	3	2	1	0
1	1	1	1	0	0	1	0	0	0	Source Effective Address					
										Mode		Register			
1	0	0	0	1	0	0	0	0	0	0	0	0	0	0	0

FMOVE to FPCR**0xF2— 9000**

15	14	13	12	11	10	9	8	7	6	5	4	3	2	1	0
1	1	1	1	0	0	1	0	0	0	Source Effective Address					
										Mode		Register			
1	0	0	1	0	0	0	0	0	0	0	0	0	0	0	0

FMOVE from FPIAR**0xF2— A400**

15	14	13	12	11	10	9	8	7	6	5	4	3	2	1	0
1	1	1	1	0	0	1	0	0	0	Destination Effective Address					
										Mode		Register			
1	0	1	0	0	1	0	0	0	0	0	0	0	0	0	0

FMOVE from FPSR**0xF2— A800**

15	14	13	12	11	10	9	8	7	6	5	4	3	2	1	0
1	1	1	1	0	0	1	0	0	0	Destination Effective Address					
										Mode		Register			
1	0	1	0	1	0	0	0	0	0	0	0	0	0	0	0

FMOVE from FPCR**0xF2— B000**

15	14	13	12	11	10	9	8	7	6	5	4	3	2	1	0
1	1	1	1	0	0	1	0	0	0	Destination Effective Address					
										Mode		Register			
1	0	1	1	0	0	0	0	0	0	0	0	0	0	0	0

FMOVEM**0xF2— -0—**

15	14	13	12	11	10	9	8	7	6	5	4	3	2	1	0
1	1	1	1	0	0	1	0	0	0	Effective Address					
										Mode		Register			
1	1	dr	1	0	0	0	0	Register List							

FNOP**0xF280 0000**

15	14	13	12	11	10	9	8	7	6	5	4	3	2	1	0
1	1	1	1	0	0	1	0	1	0	0	0	0	0	0	0
0	0	0	0	0	0	0	0	0	0	0	0	0	0	0	0

FSAVE

0xF3—

15	14	13	12	11	10	9	8	7	6	5	4	3	2	1	0
1	1	1	1	0	0	1	1	0	0	Destination Effective Address					
										Mode		Register			

FRESTORE

0xF3—

15	14	13	12	11	10	9	8	7	6	5	4	3	2	1	0
1	1	1	1	0	0	1	1	0	1	Source Effective Address					
										Mode		Register			

INTOUCH

0xF42—

15	14	13	12	11	10	9	8	7	6	5	4	3	2	1	0
1	1	1	1	0	1	0	0	0	0	1	0	1	Register, Ax		

CPUSHL

0xF4—

15	14	13	12	11	10	9	8	7	6	5	4	3	2	1	0
1	1	1	1	0	1	0	0	Cache		1	0	1	Register, Ax		

WDDATA

0xFB—

15	14	13	12	11	10	9	8	7	6	5	4	3	2	1	0
1	1	1	1	1	0	1	1	Size		Source Effective Address					
										Mode		Register			

WDEBUG

0xFB— 0003

15	14	13	12	11	10	9	8	7	6	5	4	3	2	1	0
1	1	1	1	1	0	1	1	1	1	Source Effective Address					
										Mode		Register			
0	0	0	0	0	0	0	0	0	0	0	0	0	0	1	1



THIS PAGE INTENTIONALLY LEFT BLANK

Chapter 10

PST/DDATA Encodings

This chapter specifies the ColdFire processor and debug module’s generation of the processor status (PST) and debug data (DDATA) output on an instruction basis. In general, the PST/DDATA output for an instruction is defined as follows:

PST = 0x1, {PST = {0x8,0x9,0xB}, DDATA= operand}

where the {...} definition is optional operand information defined by the setting of the CSR.

The CSR provides capabilities to display operands based on reference type (read, write, or both). A PST value {0x8, 0x9, or 0xB} identifies the size and presence of valid data to follow on the DDATA output {1, 2, or 4 bytes}. Additionally, for certain change-of-flow branch instructions, CSR[BTB] provides the capability to display the target instruction address on the DDATA output {2, 3, or 4 bytes} using a PST value of {0x9, 0xA, or 0xB}.

For V2 and V3 devices, PST and DDATA are separate ports; and real-time trace information is displayed on both ports concurrently. Starting with V4, the PST and DDATA outputs are combined into a single port. Real-time trace information appears as a sequence of 4-bit data values with no alignment restrictions; that is, the processor status (PST) values and operands (DDATA) may appear on either nibble of PSTDDATA[7:0]. The upper nibble (PSTDDATA[7:4]) is the most significant and yields values first. Note that the combined PSTDDATA output still displays processor status and debug data in a manner that is compatible with the displays generated with the separate PST and DDATA outputs. For further information, refer to the debug section of a device or core user’s manual.

The V5 processor provides enhanced PST/DDATA functionality, specifically in the form of PST compression across multiple machine cycles and an optional operand address trace capability. Refer to the debug section of the device or core’s reference manual for more information.

Note that not all instructions are implemented by all ColdFire processors. See [Chapter 3, “Instruction Set Summary](#) for specific details on the instruction set definitions.

10.1 User Instruction Set

[Table 10-1](#) shows the PST/DDATA specification for user-mode instructions. Rn represents any {Dn, An} register. The ‘y’ suffix denotes the source and ‘x’ denotes the destination operand. For a given instruction, the optional operand data is displayed only for those effective addresses referencing memory. The ‘DD’ nomenclature refers to the DDATA outputs.

Table 10-1. PST/DDATA Specification for User-Mode Instructions

Instruction	Operand Syntax	PST/DDATA
add.l	<ea>y,Dx	PST = 0x1, {PST = 0xB, DD = source operand}
add.l	Dy,<ea>x	PST = 0x1, {PST = 0xB, DD = source}, {PST = 0xB, DD = destination}
adda.l	<ea>y,Ax	PST = 0x1, {PST = 0xB, DD = source operand}
addi.l	#<data>,Dx	PST = 0x1
addq.l	#<data>,<ea>x	PST = 0x1, {PST = 0xB, DD = source}, {PST = 0xB, DD = destination}
addx.l	Dy,Dx	PST = 0x1
and.l	<ea>y,Dx	PST = 0x1, {PST = 0xB, DD = source operand}

Table 10-1. PST/DDATA Specification for User-Mode Instructions (Continued)

Instruction	Operand Syntax	PST/DDATA
and.l	Dy,<ea>x	PST = 0x1, {PST = 0xB, DD = source}, {PST = 0xB, DD = destination}
andi.l	#<data>,Dx	PST = 0x1
asl.l	{Dy,#<data>},Dx	PST = 0x1
asr.l	{Dy,#<data>},Dx	PST = 0x1
bcc.{b,w,l}		if taken, then PST = 0x5, else PST = 0x1
bchg.{b,l}	#<data>,<ea>x	PST = 0x1, {PST = 0x8, DD = source}, {PST = 0x8, DD = destination}
bchg.{b,l}	Dy,<ea>x	PST = 0x1, {PST = 0x8, DD = source}, {PST = 0x8, DD = destination}
bclr.{b,l}	#<data>,<ea>x	PST = 0x1, {PST = 0x8, DD = source}, {PST = 0x8, DD = destination}
bclr.{b,l}	Dy,<ea>x	PST = 0x1, {PST = 0x8, DD = source}, {PST = 0x8, DD = destination}
bitrev	Dx	PST = 0x1
bra.{b,w,l}		PST = 0x5
bset.{b,l}	#<data>,<ea>x	PST = 0x1, {PST = 0x8, DD = source}, {PST = 0x8, DD = destination}
bset.{b,l}	Dy,<ea>x	PST = 0x1, {PST = 0x8, DD = source}, {PST = 0x8, DD = destination}
bsr.{b,w,l}		PST = 0x5, {PST = 0xB, DD = destination operand}
btst.{b,l}	#<data>,<ea>x	PST = 0x1, {PST = 0x8, DD = source operand}
btst.{b,l}	Dy,<ea>x	PST = 0x1, {PST = 0x8, DD = source operand}
byterev	Dx	PST = 0x1
clr.b	<ea>x	PST = 0x1, {PST = 0x8, DD = destination operand}
clr.l	<ea>x	PST = 0x1, {PST = 0xB, DD = destination operand}
clr.w	<ea>x	PST = 0x1, {PST = 0x9, DD = destination operand}
cmp.b	<ea>y,Dx	PST = 0x1, {0x8, source operand}
cmp.l	<ea>y,Dx	PST = 0x1, {PST = 0xB, DD = source operand}
cmp.w	<ea>y,Dx	PST = 0x1, {0x9, source operand}
cmpa.l	<ea>y,Ax	PST = 0x1, {PST = 0xB, DD = source operand}
cmpa.w	<ea>y,Ax	PST = 0x1, {0x9, source operand}
cmpi.b	#<data>,Dx	PST = 0x1
cmpi.l	#<data>,Dx	PST = 0x1
cmpi.w	#<data>,Dx	PST = 0x1
divs.l	<ea>y,Dx	PST = 0x1, {PST = 0xB, DD = source operand}
divs.w	<ea>y,Dx	PST = 0x1, {PST = 0x9, DD = source operand}
divu.l	<ea>y,Dx	PST = 0x1, {PST = 0xB, DD = source operand}
divu.w	<ea>y,Dx	PST = 0x1, {PST = 0x9, DD = source operand}
eor.l	Dy,<ea>x	PST = 0x1, {PST = 0xB, DD = source}, {PST = 0xB, DD = destination}

Table 10-1. PST/DDATA Specification for User-Mode Instructions (Continued)

Instruction	Operand Syntax	PST/DDATA
eori.l	#<data>,Dx	PST = 0x1
ext.l	Dx	PST = 0x1
ext.w	Dx	PST = 0x1
extb.l	Dx	PST = 0x1
ff1	Dx	PST = 0x1
illegal		PST = 0x1 ¹
jmp	<ea>y	PST = 0x5, {PST = {0x9,0xA,0xB}, DD = target address} ²
jsr	<ea>y	PST = 0x5, {PST = {0x9,0xA,0xB}, DD = target address}, {PST = 0xB, DD = destination operand} ²
lea.l	<ea>y,Ax	PST = 0x1
link.w	Ay,#<displacement>	PST = 0x1, {PST = 0xB, DD = destination operand}
lsl.l	{Dy,#<data>},Dx	PST = 0x1
lsr.l	{Dy,#<data>},Dx	PST = 0x1
mov3q.l	#<data>,<ea>x	PST = 0x1, {0xB, destination operand}
move.b	<ea>y,<ea>x	PST = 0x1, {PST = 0x8, DD = source}, {PST = 0x8, DD = destination}
move.l	<ea>y,<ea>x	PST = 0x1, {PST = 0xB, DD = source}, {PST = 0xB, DD = destination}
move.w	<ea>y,<ea>x	PST = 0x1, {PST = 0x9, DD = source}, {PST = 0x9, DD = destination}
move.w	CCR,Dx	PST = 0x1
move.w	{Dy,#<data>},CCR	PST = 0x1
movea.l	<ea>y,Ax	PST = 0x1, {PST = 0xB, DD = source}
movea.w	<ea>y,Ax	PST = 0x1, {PST = 0x9, DD = source}
movem.l	#list,<ea>x	PST = 0x1, {PST = 0xB, DD = destination},... ³
movem.l	<ea>y,#list	PST = 0x1, {PST = 0xB, DD = source},... ³
moveq.l	#<data>,Dx	PST = 0x1
muls.l	<ea>y,Dx	PST = 0x1, {PST = 0xB, DD = source operand}
muls.w	<ea>y,Dx	PST = 0x1, {PST = 0x9, DD = source operand}
mulu.l	<ea>y,Dx	PST = 0x1, {PST = 0xB, DD = source operand}
mulu.w	<ea>y,Dx	PST = 0x1, {PST = 0x9, DD = source operand}
mvs.b	<ea>y,Dx	PST = 0x1, {0x8, source operand}
mvs.w	<ea>y,Dx	PST = 0x1, {0x9, source operand}
mvz.b	<ea>y,Dx	PST = 0x1, {0x8, source operand}
mvz.w	<ea>y,Dx	PST = 0x1, {0x9, source operand}
neg.l	Dx	PST = 0x1

Table 10-1. PST/DDATA Specification for User-Mode Instructions (Continued)

Instruction	Operand Syntax	PST/DDATA
negx.l	Dx	PST = 0x1
nop		PST = 0x1
not.l	Dx	PST = 0x1
or.l	<ea>y,Dx	PST = 0x1, {PST = 0xB, DD = source operand}
or.l	Dy,<ea>x	PST = 0x1, {PST = 0xB, DD = source}, {PST = 0xB, DD = destination}
ori.l	#<data>,Dx	PST = 0x1
pea.l	<ea>y	PST = 0x1, {PST = 0xB, DD = destination operand}
pulse		PST = 0x4
rems.l	<ea>y,Dw:Dx	PST = 0x1, {PST = 0xB, DD = source operand}
remu.l	<ea>y,Dw:Dx	PST = 0x1, {PST = 0xB, DD = source operand}
rts		PST = 0x1, PST = 0x5, {{0x9,0xA,0xB}, target address} PST = 0x1, {PST = 0xB, DD = source operand}, PST = 0x5, {PST = {0x9,0xA,0xB}, DD = target address}
sats.l	Dx	PST = 0x1
scc.b	Dx	PST = 0x1
sub.l	<ea>y,Dx	PST = 0x1, {PST = 0xB, DD = source operand}
sub.l	Dy,<ea>x	PST = 0x1, {PST = 0xB, DD = source}, {PST = 0xB, DD = destination}
suba.l	<ea>y,Ax	PST = 0x1, {PST = 0xB, DD = source operand}
subi.l	#<data>,Dx	PST = 0x1
subq.l	#<data>,<ea>x	PST = 0x1, {PST = 0xB, DD = source}, {PST = 0xB, DD = destination}
subx.l	Dy,Dx	PST = 0x1
swap.w	Dx	PST = 0x1
tas.b	<ea>x	PST = 0x1, {0x8, source}, {0x8, destination}
tpf		PST = 0x1
tpf.l	#<data>	PST = 0x1
tpf.w	#<data>	PST = 0x1
trap	#<data>	PST = 0x1 ¹
tst.b	<ea>x	PST = 0x1, {PST = 0x8, DD = source operand}
tst.l	<ea>y	PST = 0x1, {PST = 0xB, DD = source operand}
tst.w	<ea>y	PST = 0x1, {PST = 0x9, DD = source operand}
unlk	Ax	PST = 0x1, {PST = 0xB, DD = destination operand}
wddata.b	<ea>y	PST = 0x4, {PST = 0x8, DD = source operand}

Table 10-1. PST/DDATA Specification for User-Mode Instructions (Continued)

Instruction	Operand Syntax	PST/DDATA
wddata.l	<ea>y	PST = 0x4, {PST = 0xB, DD = source operand}
wddata.w	<ea>y	PST = 0x4, {PST = 0x9, DD = source operand}

¹ During normal exception processing, the PST output is driven to a 0xC indicating the exception processing state. The exception stack write operands, as well as the vector read and target address of the exception handler may also be displayed.

Exception ProcessingPST = 0xC,{PST = 0xB,DD = destination},//stack frame

{PST = 0xB,DD = destination},// stack frame

{PST = 0xB,DD = source},// vector read

PST = 0x5,{PST = [0x9AB],DD = target}// handlerPC

The PST/DDATA specification for the reset exception is shown below:

Exception ProcessingPST = 0xC,

PST = 0x5,{PST = [0x9AB],DD = target}/ handlerPC

The initial references at address 0 and 4 are never captured nor displayed since these accesses are treated as instruction fetches.

For all types of exception processing, the PST = 0xC value is driven at all times, unless the PST output is needed for one of the optional marker values or for the taken branch indicator (0x5).

² For JMP and JSR instructions, the optional target instruction address is displayed only for those effective address fields defining variant addressing modes. This includes the following <ea>x values: (An), (d16,An), (d8,An,Xi), (d8,PC,Xi).

³ For Move Multiple instructions (MOVEM), the processor automatically generates line-sized transfers if the operand address reaches a 0-modulo-16 boundary and there are four or more registers to be transferred. For these line-sized transfers, the operand data is never captured nor displayed, regardless of the CSR value. The automatic line-sized burst transfers are provided to maximize performance during these sequential memory access operations.

Table 10-2 shows the PST specification for multiply-accumulate instructions.

Table 10-2. PST/DDATA Values for User-Mode Multiply-Accumulate Instructions

Instruction	Operand Syntax	PST/DDATA
m*ac.l ¹	Ry,Rx,ACCx{,ACCw}	PST = 0x1
m*ac.l ¹	Ry,Rx,<ea>y,Rw,ACCx	PST = 0x1, {PST = 0xB, DD = source operand}
m*ac.w ¹	Ry,Rx,ACCx{,ACCw}	PST = 0x1
m*ac.w ¹	Ry,Rx,<ea>y,Rw,ACCx	PST = 0x1, {PST = 0xB, DD = source operand}
move.l	{Ry,#<data>},ACCext01	PST = 0x1
move.l	{Ry,#<data>},ACCext23	PST = 0x1
move.l	{Ry,#<data>},ACCx	PST = 0x1
move.l	{Ry,#<data>},MACSR	PST = 0x1
move.l	{Ry,#<data>},MASK	PST = 0x1
move.l	ACCext01,Rx	PST = 0x1
move.l	ACCext23,Rx	PST = 0x1
move.l	ACCy,ACCx	PST = 0x1

Table 10-2. PST/DDATA Values for User-Mode Multiply-Accumulate Instructions (Continued)

Instruction	Operand Syntax	PST/DDATA
move.l	ACCy,Rx	PST = 0x1
move.l	MACSR,CCR	PST = 0x1
move.l	MACSR,Rx	PST = 0x1
move.l	MASK,Rx	PST = 0x1

¹ m*ac refers to mac, msac, maaac, masac, msaac, mssac instructions

Table 10-3 shows the PST/DDATA specification for floating-point instructions; note that <ea>y includes FPy, Dy, Ay, and <mem>y addressing modes. The optional operand capture and display applies only to the <mem>y addressing modes. Note also that the PST/DDATA values are the same for a given instruction, regardless of explicit rounding precision.

Table 10-3. PST/DDATA Values for User-Mode Floating-Point Instructions

Instruction	Operand Syntax	PST/DDATA
fabs.sz	<ea>y,FPx	PST = 0x1, [89B], source}
fadd.sz	<ea>y,FPx	PST = 0x1, [89B], source}
fbcc.{w,l}	<label>	if taken, then PST = 5, else PST = 0x1
fcmp.sz	<ea>y,FPx	PST = 0x1, [89B], source}
fdiv.sz	<ea>y,FPx	PST = 0x1, [89B], source}
fint.sz	<ea>y,FPx	PST = 0x1, [89B], source}
fintrz.sz	<ea>y,FPx	PST = 0x1, [89B], source}
fmove.sz	<ea>y,FPx	PST = 0x1, [89B], source}
fmove.sz	FPy,<ea>x	PST = 0x1, [89B], destination}
fmove.l	<ea>y,FP*R ¹	PST = 0x1, B, source}
fmove.l	FP*R,<ea>x ¹	PST = 0x1, B, destination}
fmovem	<ea>y,#list	PST = 0x1
fmovem	#list,<ea>x	PST = 0x1
fmul.sz	<ea>y,FPx	PST = 0x1, [89B], source}
fneg.sz	<ea>y,FPx	PST = 0x1, [89B], source}
fnop		PST = 0x1
fsqrt.sz	<ea>y,FPx	PST = 0x1, [89B], source}
fsub.sz	<ea>y,FPx	PST = 0x1, [89B], source}
ftst.sz	<ea>y	PST = 0x1, [89B], source}

¹ The FP*R notation refers to the floating-point control registers: FPCR, FPSR, and FPIAR.

Depending on the size of any external memory operand specified by the f<op>.fmt field, the data marker is defined as shown in [Table 10-4](#)

Table 10-4. Data Markers and FPU Operand Format Specifiers

Format Specifier	Data Marker
.b	8
.w	9
.l	B
.s	B
.d	Never captured

10.2 Supervisor Instruction Set

The supervisor instruction set has complete access to the user mode instructions plus the opcodes shown below. The PST/DDATA specification for these opcodes is shown in [Table 10-5](#).

Table 10-5. PST/DDATA Specifications for Supervisor-Mode Instructions

Instruction	Operand Syntax	PST/DDATA
cpushl	dc,(Ax) ic,(Ax) bc,(Ax)	PST = 0x1
frestore	<ea>y	PST = 0x1
fsave	<ea>x	PST = 0x1
halt		PST = 0x1, PST = 0xF
intouch	(Ay)	PST = 0x1
move.l	Ay,USP	PST = 0x1
move.l	USP,Ax	PST = 0x1
move.w	SR,Dx	PST = 0x1
move.w	{Dy,#<data>},SR	PST = 0x1, {PST = 0x3}
movec.l	Ry,Rc	PST = 0x1, {8, ASID}
rte		PST = 0x7, {PST = 0xB, DD = source operand}, {PST = 3} { PST = 0xB, DD =source operand}, {DD}, PST = 0x5, {[PST = 0x9AB], DD = target address}
stldsr	#<data>	PST = 0x1, {PST = 0xB, DD = destination}
stop	#<data>	PST = 0x1, PST = 0xE
wdebug.l	<ea>y	PST = 0x1, {PST = 0xB, DD = source, PST = 0xB, DD = source}



The move-to-SR and RTE instructions include an optional PST = 0x3 value, indicating an entry into user mode. Additionally, if the execution of a RTE instruction returns the processor to emulator mode, a multiple-cycle status of 0xD is signaled.

Similar to the exception processing mode, the stopped state (PST = 0xE) and the halted state (PST = 0xF) display this status throughout the entire time the ColdFire processor is in the given mode.

Chapter 11

Exception Processing

This chapter describes exception processing for the ColdFire family.

11.1 Overview

Exception processing for ColdFire processors is streamlined for performance. Differences from previous M68000 Family processors include the following:

- A simplified exception vector table
- Reduced relocation capabilities using the vector base register
- A single exception stack frame format
- Use of a single, self-aligning stack pointer (for ISA_A implementations only)

Beginning with the eV4 core, support for an optional virtual memory management unit is provided. For devices containing an MMU, the exception processing is slightly modified. Differences from previous ColdFire Family processors are related to the instruction restart model for translation (TLB miss) and access faults. This functionality extends the original ColdFire access error fault vector and exception stack frames.

Earlier ColdFire processors (V2 and V3) use an instruction restart exception model but require additional software support to recover from certain access errors.

Exception processing can be defined as the time from the detection of the fault condition until the fetch of the first handler instruction has been initiated. It consists of the following four major steps:

1. The processor makes an internal copy of the status register (SR) and then enters supervisor mode by setting SR[S] and disabling trace mode by clearing SR[T]. The occurrence of an interrupt exception also clears SR[M] and sets the interrupt priority mask, SR[I] to the level of the current interrupt request.
2. The processor determines the exception vector number. For all faults except interrupts, the processor bases this calculation on exception type. For interrupts, the processor performs an interrupt acknowledge (IACK) bus cycle to obtain the vector number from peripheral. The IACK cycle is mapped to a special acknowledge address space with the interrupt level encoded in the address.
3. The processor saves the current context by creating an exception stack frame on the system stack. Processors implementing ISA_A support a single stack pointer in the A7 address register; therefore, there is no notion of separate supervisor and user stack pointers. As a result, the exception stack frame is created at a 0-modulo-4 address on top of the current system stack. For processors implementing all other ISA revisions and supporting 2 stack pointers, the exception stack frame is created at a 0-modulo-4 address on top of the system stack pointed to by the Supervisor Stack Pointer (SSP). All ColdFire processors use a simplified fixed-length stack frame, shown in [Figure 11-1](#), for all exceptions. In addition, processor cores supporting an MMU use the same fixed-length stack frame with additional fault status (FS) encodings to support the MMU. In some exception types, the program counter (PC) in the exception stack frame contains the address of the faulting instruction (fault); in others, the PC contains the next instruction to be executed (next).

If the exception is caused by an FPU instruction, the PC contains the address of either the next floating-point instruction (nextFP) if the exception is pre-instruction, or the faulting instruction (fault) if the exception is post-instruction.

4. The processor acquires the address of the first instruction of the exception handler. The instruction address is obtained by fetching a value from the exception table at the address in the vector base register. The index into the table is calculated as $4 \times \text{vector_number}$. When the index value is generated, the vector table contents determine the address of the first instruction of the desired handler. After the fetch of the first opcode of the handler is initiated, exception processing terminates and normal instruction processing continues in the handler.

The vector base register described in [Section 1.5.3, “Vector Base Register \(VBR\)”](#) holds the base address of the exception vector table in memory. The displacement of an exception vector is added to the value in this register to access the vector table. VBR[19–0] are not implemented and are assumed to be zero, forcing the vector table to be aligned on a 0-modulo-1-Mbyte boundary.

ColdFire processors support a 1024-byte vector table as shown in [Table 11-1](#). The table contains 256 exception vectors, the first 64 of which are defined by Motorola. The rest are user-defined interrupt vectors.

Table 11-1. Exception Vector Assignments

Vector Numbers	Vector Offset (Hex)	Stacked Program Counter ¹	Assignment
0	000	—	Initial stack pointer (SSP for cores with dual stack pointers)
1	004	—	Initial program counter
2	008	Fault	Access error
3	00C	Fault	Address error
4	010	Fault	Illegal instruction
5 ²	014	Fault	Divide by zero
6–7	018–01C	—	Reserved
8	020	Fault	Privilege violation
9	024	Next	Trace
10	028	Fault	Unimplemented line-a opcode
11	02C	Fault	Unimplemented line-f opcode
12 ³	030	Next	Non-PC breakpoint debug interrupt
13 ³	034	Next	PC breakpoint debug interrupt
14	038	Fault	Format error
15	03C	Next	Uninitialized interrupt
16–23	040–05C	—	Reserved
24	060	Next	Spurious interrupt
25–31 ⁴	064–07C	Next	Level 1–7 autovectored interrupts
32–47	080–0BC	Next	Trap #0–15 instructions

Table 11-1. Exception Vector Assignments (Continued)

Vector Numbers	Vector Offset (Hex)	Stacked Program Counter ¹	Assignment
48 ⁵	0C0	Fault	Floating-point branch on unordered condition
49 ⁵	0C4	NextFP or Fault	Floating-point inexact result
50 ⁵	0C8	NextFP	Floating-point divide-by-zero
51 ⁵	0CC	NextFP or Fault	Floating-point underflow
52 ⁵	0D0	NextFP or Fault	Floating-point operand error
53 ⁵	0D4	NextFP or Fault	Floating-point overflow
54 ⁵	0D8	NextFP or Fault	Floating-point input not-a-number (NaN)
55 ⁵	0DC	NextFP or Fault	Floating-point input denormalized number
56–60	0E0–0F0	—	Reserved
61 ⁶	0F4	Fault	Unsupported instruction
62–63	0F8–0FC	—	Reserved
64–255	100–3FC	Next	User-defined interrupts

¹ 'Fault' refers to the PC of the faulting instruction. 'Next' refers to the PC of the instruction immediately after the faulting instruction. 'NextFP' refers to the PC of the next floating-point instruction.

² If the divide unit is not present (5202, 5204, 5206), vector 5 is reserved.

³ On V2 and V3, all debug interrupts use vector 12; vector 13 is reserved.

⁴ Support for autovectored interrupts is dependent on the interrupt controller implementation. Consult the specific device reference manual for additional details.

⁵ If the FPU is not present, vectors 48 - 55 are reserved.

⁶ Some devices do not support this exception; refer to [Table 11-3](#).

ColdFire processors inhibit sampling for interrupts during the first instruction of all exception handlers. This allows any handler to effectively disable interrupts, if necessary, by raising the interrupt mask level in the SR.

11.1.1 Supervisor/User Stack Pointers (A7 and OTHER_A7)

Some ColdFire cores support two unique stack pointer (A7) registers: the supervisor stack pointer (SSP) and the user stack pointer (USP). This support provides the required isolation between operating modes. Note that only the SSP is used during creation of the exception stack frame.

The hardware implementation of these two program-visible 32-bit registers does not uniquely identify one as the SSP and the other as the USP. Rather, the hardware uses one 32-bit register as the currently-active A7 and the other as OTHER_A7. Thus, the register contents are a function of the processor operating mode:

```

if SR[S] = 1
    then
        A7 = Supervisor Stack Pointer
        other_A7 = User Stack Pointer
else
    A7 = User Stack Pointer
    other_A7 = Supervisor Stack Pointer

```

The BDM programming model supports reads and writes to A7 and OTHER_A7 directly. It is the responsibility of the external development system to determine the mapping of A7 and OTHER_A7 to the two program-visible definitions (SSP and USP), based on the setting of SR[S]. This functionality is enabled by setting by the dual stack pointer enable bit CACR[DSPE]. If this bit is cleared, only the stack pointer, A7 (defined for previous ColdFire versions), is available. DSPE is zero at reset.

If DSPE is set, the appropriate stack pointer register (SSP or USP) is accessed as a function of the processor's operating mode. To support dual stack pointers, the following two privileged MC680x0 instructions to load/store the USP are added to the ColdFire instruction set architecture as part of ISA_B:

```
mov.l Ay,USP # move to USP: opcode = 0x4E6(0xxx)
```

```
mov.l USP,Ax # move from USP: opcode = 0x4E6(1xxx)
```

The address register number is encoded in the low-order three bits of the opcode.

11.1.2 Exception Stack Frame Definition

The first longword of the exception stack frame, [Figure 11-1](#), holds the 16-bit format/vector word (F/V) and 16-bit status register. The second holds the 32-bit program counter address.

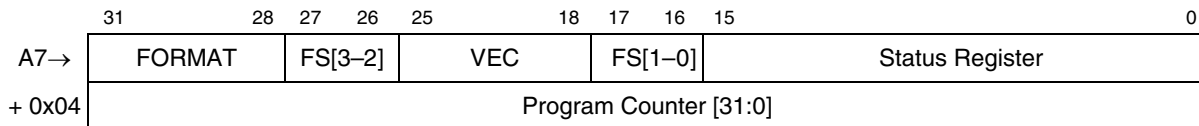

Figure 11-1. Exception Stack Frame

[Table 11-2](#) describes F/V fields. FS encodings added to support the MMU are noted.

Table 11-2. Format/Vector Word

Bits	Field	Description															
31-28	FORMAT	Format field. Written with a value of {4,5,6,7} by the processor indicating a 2-longword frame format. FORMAT records any longword stack pointer misalignment when the exception occurred. <table border="1" style="border-collapse: collapse; width: 100%; margin-top: 5px;"> <thead> <tr> <th style="text-align: center;">A7 at Time of Exception, Bits[1:0]</th> <th style="text-align: center;">A7 at First Instruction of Handler</th> <th style="text-align: center;">FORMAT</th> </tr> </thead> <tbody> <tr> <td style="text-align: center;">00</td> <td style="text-align: center;">Original A7—8</td> <td style="text-align: center;">0100</td> </tr> <tr> <td style="text-align: center;">01</td> <td style="text-align: center;">Original A7—9</td> <td style="text-align: center;">0101</td> </tr> <tr> <td style="text-align: center;">10</td> <td style="text-align: center;">Original A7—10</td> <td style="text-align: center;">0110</td> </tr> <tr> <td style="text-align: center;">11</td> <td style="text-align: center;">Original A7—11</td> <td style="text-align: center;">0111</td> </tr> </tbody> </table>	A7 at Time of Exception, Bits[1:0]	A7 at First Instruction of Handler	FORMAT	00	Original A7—8	0100	01	Original A7—9	0101	10	Original A7—10	0110	11	Original A7—11	0111
A7 at Time of Exception, Bits[1:0]	A7 at First Instruction of Handler	FORMAT															
00	Original A7—8	0100															
01	Original A7—9	0101															
10	Original A7—10	0110															
11	Original A7—11	0111															

Table 11-2. Format/Vector Word (Continued)

Bits	Field	Description
27–26	FS[3–2]	Fault status. Defined for access and address errors and for interrupted debug service routines. 0000 Not an access or address error nor an interrupted debug service routine 0001 Reserved 0010 Interrupt during a debug service routine for faults other than access errors. (V4 and beyond, if MMU) ¹ 0011 Reserved 0100 Error (for example, protection fault) on instruction fetch 0101 TLB miss on opword of instruction fetch (V4 and beyond, if MMU) 0110 TLB miss on extension word of instruction fetch (V4 and beyond, if MMU) 0111 IFP access error while executing in emulator mode (V4 and beyond, if MMU) 1000 Error on data write 1001 Error on attempted write to write-protected space 1010 TLB miss on data write (V4 and beyond, if MMU) 1011 Reserved 1100 Error on data read 1101 Attempted read, read-modify-write of protected space(V4 and beyond, if MMU) 1110 TLB miss on data read, or read-modify-write (V4 and beyond, if MMU) 1111 OEP access error while executing in emulator mode (V4 and beyond, if MMU)
25–18	VEC	Vector number. Defines the exception type. It is calculated by the processor for internal faults and is supplied by the peripheral for interrupts. See Table 11-1 .
17–16	FS[1–0]	See bits 27–26.

¹ This generally refers to taking an I/O interrupt while in a debug service routine but also applies to other fault types. If an access error occurs during a debug service routine, FS is set to 0111 if it is due to an instruction fetch or to 1111 for a data access. This applies only to access errors with the MMU present. If an access error occurs without an MMU, FS is set to 0010.

11.1.3 Processor Exceptions

[Table 11-3](#) describes ColdFire core exceptions. Note that if a ColdFire processor encounters any fault while processing another fault, it immediately halts execution with a catastrophic fault-on-fault condition. A reset is required to force the processor to exit this halted state.

11.1.4 Floating-Point Arithmetic Exceptions

This section describes floating-point arithmetic exceptions; [Table 11-3](#) lists these exceptions in order of priority:

Table 11-3. Exception Priorities

Priority	Exception
1	Branch/set on unordered (BSUN)
2	Input Not-a-Number (INAN)
3	Input denormalized number (IDE)
4	Operand error (OPERR)
5	Overflow (OVFL)
6	Underflow (UNFL)

Table 11-3. Exception Priorities (Continued)

Priority	Exception
7	Divide-by-zero (DZ)
8	Inexact (INEX)

Most floating-point exceptions are taken when the next floating-point arithmetic instruction is encountered (this is called a pre-instruction exception). Exceptions set during a floating-point store to memory or to an integer register are taken immediately (post-instruction exception).

Note that FMOVE is considered an arithmetic instruction because the result is rounded. Only FMOVE with any destination other than a floating-point register (sometimes called FMOVE OUT) can generate post-instruction exceptions. Post-instruction exceptions never write the destination. After a post-instruction exception, processing continues with the next instruction.

A floating-point arithmetic exception becomes pending when the result of a floating-point instruction sets an FPSR[EXC] bit and the corresponding FPCR[ENABLE] bit is set. A user write to the FPSR or FPCR that causes the setting of an exception bit in FPSR[EXC] along with its corresponding exception enabled in FPCR, leaves the FPU in an exception-pending state. The corresponding exception is taken at the start of the next arithmetic instruction as a pre-instruction exception.

Executing a single instruction can generate multiple exceptions. When multiple exceptions occur with exceptions enabled for more than one exception class, the highest priority exception is reported and taken. It is up to the exception handler to check for multiple exceptions. The following multiple exceptions are possible:

- Operand error (OPERR) and inexact result (INEX)
- Overflow (OVFL) and inexact result (INEX)
- Underflow (UNFL) and inexact result (INEX)
- Divide-by-zero (DZ) and inexact result (INEX)
- Input denormalized number (IDE) and inexact result (INEX)
- Input not-a-number (INAN) and input denormalized number (IDE)

In general, all exceptions behave similarly. If the exception is disabled when the exception condition exists, no exception is taken, a default result is written to the destination (except for BSUN exception, which has no destination), and execution proceeds normally.

If an enabled exception occurs, the same default result above is written for pre-instruction exceptions but no result is written for post-instruction exceptions.

An exception handler is expected to execute FSAVE as its first floating-point instruction. This also clears FPCR, which keeps exceptions from occurring during the handler. Because the destination is overwritten for floating-point register destinations, the original floating-point destination register value is available for the handler on the FSAVE state frame. The address of the instruction that caused the exception is available in the FPIAR. When the handler is done, it should clear the appropriate FPSR exception bit on the FSAVE state frame, then execute FRESTORE. If the exception status bit is not cleared on the state frame, the same exception occurs again.

Alternatively, instead of executing FSAVE, an exception handler could simply clear appropriate FPSR exception bits, optionally alter FPCR, and then return from the exception. Note that exceptions are never taken on FMOVE to or from the status and control registers and FMOVEM to or from the floating-point data registers.

At the completion of the exception handler, the RTE instruction must be executed to return to normal instruction flow.

11.1.5 Branch/Set on Unordered (BSUN)

A BSUN results from performing an IEEE nonaware conditional test associated with the FBcc instruction when an unordered condition is present. Any pending floating-point exception is first handled by a pre-instruction exception, after which the conditional instruction restarts. The conditional predicate is evaluated and checked for a BSUN exception before executing the conditional instruction. A BSUN exception occurs if the conditional predicate is an IEEE non-aware branch and FPCC[NAN] is set. When this condition is detected, FPSR[BSUN] is set. [Table 11-4](#) shows the results when the exception is enabled or disabled.

Table 11-4. BSUN Exception Enabled/Disabled Results

Condition	BSUN	Description
Exception disabled	0	The floating-point condition is evaluated as if it were the equivalent IEEE-aware conditional predicate. No exceptions are taken.
Exception Enabled	1	The processor takes a floating-point pre-instruction exception. The BSUN exception is unique in that the exception is taken before the conditional predicate is evaluated. If the user BSUN exception handler fails to update the PC to the instruction after the excepting instruction when returning, the exception executes again. Any of the following actions prevent taking the exception again: <ul style="list-style-type: none"> • Clearing FPSR[NAN] • Disabling FPCR[BSUN] • Incrementing the stored PC in the stack bypasses the conditional instruction. This applies to situations where fall-through is desired. Note that to accurately calculate the PC increment requires knowledge of the size of the bypassed conditional instruction.

11.1.6 Input Not-A-Number (INAN)

The INAN exception is a mechanism for handling a user-defined, non-IEEE data type. If either input operand is a NAN, FPSR[INAN] is set. By enabling this exception, the user can override the default action taken for NAN operands. Because FMOVEM, FMOVE FPCR, and FSAVE instructions do not modify status bits, they cannot generate exceptions. Therefore, these instructions are useful for manipulating INANs. See [Table 11-5](#).

Table 11-5. INAN Exception Enabled/Disabled Results

Condition	INAN	Description
Exception disabled	0	If the destination data format is single- or double-precision, a NAN is generated with a mantissa of all ones and a sign of zero transferred to the destination. If the destination data format is B, W, or L, a constant of all ones is written to the destination.
Exception enabled	1	The result written to the destination is the same as the exception disabled case, unless the exception occurs on a FMOVE OUT, in which case the destination is unaffected.

11.1.7 Input Denormalized Number (IDE)

The input denorm bit, FPCR[IDE], provides software support for denormalized operands. When the IDE exception is disabled, the operand is treated as zero, FPSR[INEX] is set, and the operation proceeds. When the IDE exception is enabled and an operand is denormalized, an IDE exception is taken but FPSR[INEX] is not set to allow the handler to set it appropriately. See [Table 11-6](#).

Note that the FPU never generates denormalized numbers. If necessary, software can create them in the underflow exception handler.

Table 11-6. IDE Exception Enabled/Disabled Results

Condition	IDE	Description
Exception disabled	0	Any denormalized operand is treated as zero, FPSR[INEX] is set, and the operation proceeds.
Exception enabled	1	The result written to the destination is the same as the exception disabled case unless the exception occurs on a FMOVE OUT, in which case the destination is unaffected. FPSR[INEX] is not set to allow the handler to set it appropriately.

11.1.8 Operand Error (OPERR)

The operand error exception encompasses problems arising in a variety of operations, including errors too infrequent or trivial to merit a specific exceptional condition. Basically, an operand error occurs when an operation has no mathematical interpretation for the given operands. [Table 11-7](#) lists possible operand errors. When one occurs, FPSR[OPERR] is set.

Table 11-7. Possible Operand Errors

Instruction	Condition Causing Operand Error
FADD	$[(+\infty) + (-\infty)]$ or $[(-\infty) + (+\infty)]$
FDIV	$(0 \div 0)$ or $(\infty \div \infty)$
FMOVE OUT (to B, W, or L)	Integer overflow, source is NAN or $\pm\infty$
FMUL	One operand is 0 and the other is $\pm\infty$
FSQRT	Source is < 0 or $-\infty$
FSUB	$[(+\infty) - (+\infty)]$ or $[(-\infty) - (-\infty)]$

[Table 11-8](#) describes results when the exception is enabled and disabled.

Table 11-8. OPERR Exception Enabled/Disabled Results

Condition	OPERR	Description
Exception disabled	0	When the destination is a floating-point data register, the result is a double-precision NAN, with its mantissa set to all ones and the sign set to zero (positive). For a FMOVE OUT instruction with the format S or D, an OPERR exception is impossible. With the format B, W, or L, an OPERR exception is possible only on a conversion to integer overflow, or if the source is either an infinity or a NAN. On integer overflow and infinity source cases, the largest positive or negative integer that can fit in the specified destination size (B, W, or L) is stored. In the NAN source case, a constant of all ones is written to the destination.
Exception enabled	1	The result written to the destination is the same as for the exception disabled case unless the exception occurred on a FMOVE OUT, in which case the destination is unaffected. If desired, the user OPERR handler can overwrite the default result.

11.1.9 Overflow (OVFL)

An overflow exception is detected for arithmetic operations in which the destination is a floating-point data register or memory when the intermediate result's exponent is greater than or equal to the maximum exponent value of the selected rounding precision. Overflow occurs only when the destination is S- or D-precision format; overflows for other formats are handled as operand errors. At the end of any operation that could potentially overflow, the intermediate result is checked for underflow, rounded, and then checked for overflow before it is stored to the destination. If overflow occurs, FPSR[OVFL,INEX] are set.

Even if the intermediate result is small enough to be represented as a double-precision number, an overflow can occur if the magnitude of the intermediate result exceeds the range of the selected rounding precision format. See [Table 11-9](#).

Table 11-9. OVFL Exception Enabled/Disabled Results

Condition	OVFL	Description
Exception disabled	0	The values stored in the destination based on the rounding mode defined in FPCR[MODE]. RN Infinity, with the sign of the intermediate result. RZ Largest magnitude number, with the sign of the intermediate result. RM For positive overflow, largest positive normalized number For negative overflow, $-\infty$. RP For positive overflow, $+\infty$ For negative overflow, largest negative normalized number.
Exception enabled	1	The result written to the destination is the same as for the exception disabled case unless the exception occurred on a FMOVE OUT, in which case the destination is unaffected. If desired, the user OVFL handler can overwrite the default result.

11.1.10 Underflow (UNFL)

An underflow exception occurs when the intermediate result of an arithmetic instruction is too small to be represented as a normalized number in a floating-point register or memory using the selected rounding precision, that is, when the intermediate result exponent is less than or equal to the minimum exponent value of the selected rounding precision. Underflow can only occur when the destination format is single or double precision. When the destination is byte, word, or longword, the conversion underflows to zero without causing an underflow or an operand error. At the end of any operation that could underflow, the intermediate result is checked for underflow, rounded, and checked for overflow before it is stored in the destination. FPSR[UNFL] is set if underflow occurs. If the underflow exception is disabled, FPSR[INEX] is also set.

Even if the intermediate result is large enough to be represented as a double-precision number, an underflow can occur if the magnitude of the intermediate result is too small to be represented in the selected rounding precision. [Table 11-10](#) shows results when the exception is enabled or disabled.

Table 11-10. UNFL Exception Enabled/Disabled Results

Condition	UNFL	Description
Exception disabled	0	The stored result is defined below. The UNFL exception also sets FPSR[INEX] if the UNFL exception is disabled. RN Zero, with the sign of the intermediate result RZ Zero, with the sign of the intermediate result RM For positive underflow, + 0 For negative underflow, smallest negative normalized number RP For positive underflow, smallest positive normalized number For negative underflow, - 0
Exception enabled	1	The result written to the destination is the same as for the exception disabled case, unless the exception occurs on a FMOVE OUT, in which case the destination is unaffected. If desired, the user UNFL handler can overwrite the default result. The UNFL exception does not set FPSR[INEX] if the UNFL exception is enabled so the exception handler can set FPSR[INEX] based on results it generates.

11.1.11 Divide-by-Zero (DZ)

Attempting to use a zero divisor for a divide instruction causes a divide-by-zero exception. When a divide-by-zero is detected, FPSR[DZ] is set. [Table 11-11](#) shows results when the exception is enabled or disabled.

Table 11-11. DZ Exception Enabled/Disabled Results

Condition	DZ	Description
Exception disabled	0	The destination floating-point data register is written with infinity with the sign set to the exclusive OR of the signs of the input operands.
Exception enabled	1	The destination floating-point data register is written as in the exception is disabled case.

11.1.12 Inexact Result (INEX)

An INEX exception condition exists when the infinitely precise mantissa of a floating-point intermediate result has more significant bits than can be represented exactly in the selected rounding precision or in the destination format. If this condition occurs, FPSR[INEX] is set and the infinitely precise result is rounded according to [Table 11-12](#).

Table 11-12. Inexact Rounding Mode Values

Mode	Result
RN	The representable value nearest the infinitely precise intermediate value is the result. If the two nearest representable values are equally near, the one whose lsb is 0 (even) is the result. This is sometimes called round-to-nearest-even.
RZ	The result is the value closest to and no greater in magnitude than the infinitely precise intermediate result. This is sometimes called chop-mode, because the effect is to clear bits to the right of the rounding point.
RM	The result is the value closest to and no greater than the infinitely precise intermediate result (possibly -x).
RP	The result is the value closest to and no less than the infinitely precise intermediate result (possibly +x).

FPSR[INEX] is also set for any of the following conditions:

- If an input operand is a denormalized number and the IDE exception is disabled
- An overflowed result
- An underflowed result with the underflow exception disabled

Table 11-13 shows results when the exception is enabled or disabled.

Table 11-13. INEX Exception Enabled/Disabled Results

Condition	INEX	Description
Exception disabled	0	The result is rounded and then written to the destination.
Exception enabled	1	The result written to the destination is the same as for the exception disabled case, unless the exception occurred on a FMOVE OUT, in which case the destination is unaffected. If desired, the user INEX handler can overwrite the default result.

11.1.13 MMU Changes to the Exception Processing Model

When an MMU is present in a ColdFire device, all memory references require support for precise, recoverable faults. This section details the changes in the ColdFire exception processing model due to the presence of an MMU.

The ColdFire instruction restart mechanism ensures that a faulted instruction restarts from the beginning of execution; that is, no internal state information is saved when an exception occurs and none is restored when the handler ends. Given the PC address defined in the exception stack frame, the processor reestablishes program execution by transferring control to the given location as part of the RTE (return from exception) instruction.

The instruction restart recovery model requires program-visible register changes made during execution to be undone if that instruction subsequently faults.

For V4 and beyond cores, the Operand Execution Pipeline (OEP) structure naturally supports this concept for most instructions; program-visible registers are updated only in the final OEP stage when fault collection is complete. If any type of exception occurs, pending register updates are discarded.

Most single-cycle instructions already support precise faults and instruction restart. Some complex instructions do not. Consider the following memory-to-memory move:

```
mov.l    (Ay)+, (Ax)+      # copy 4 bytes from source to destination
```

This instruction takes 1 cycle to read the source operand (Ay) and 1 to write the data into (Ax). Both the source and destination address pointers are updated as part of execution. [Table 11-14](#) lists the operations performed in execute stage (EX).

Table 11-14. OEP EX Cycle Operations

EX Cycle	Operations
1	Read source operand from memory @ (Ay), update Ay, new Ay = old Ay + 4
2	Write operand into destination memory @ (Ax), update Ax, new Ax = old Ax + 4, update CCR

A fault detected with the destination memory write is reported during the second cycle. At this point, operations performed in the first cycle are complete, so if the destination write takes any type of access error, Ay is updated. After the access error handler executes and the faulting instruction restarts, the processor's operation is incorrect because the source address register has an incorrect (post-incremented) value.

To recover the original state of the programming model for all instructions, V4 and beyond cores add the needed hardware to support full register recovery. This hardware allows program-visible registers to be restored to their original state for multi-cycle instructions so that the instruction restart mechanism is supported. Memory-to-memory moves and move multiple loads are representative of the complex instructions needing the special recovery support.

Appendix A

S-Record Output Format

The S-record format for output modules is for encoding programs or data files in a printable format for transportation between computer systems. The transportation process can be visually monitored, and the S-records can be easily edited.

A.1 S-Record Content

Visually, S-records are essentially character strings made of several fields that identify the record type, record length, memory address, code/data, and checksum. Each byte of binary data encodes as a two-character hexadecimal number: the first character represents the high-order four bits, and the second character represents the low-order four bits of the byte. [Figure A-1](#) illustrates the five fields that comprise an S-record. [Table A-1](#) lists the composition of each S-record field.

Type	Record Length	Address	Code/Data	Checksum
------	---------------	---------	-----------	----------

Figure A-1. Five Fields of an S-Record

Table A-1. Field Composition of an S-Record

Field	Printable Characters	Contents
Type	2	S-record type—S0, S1, etc.
Record Length	2	The count of the character pairs in the record, excluding the type and record length.
Address	4, 6, or 8	The 2-, 3-, or 4-byte address at which the data field is to be loaded into memory.
Code/Data	0–2n	From 0 to n bytes of executable code, memory loadable data, or descriptive information. Some programs may limit the number of bytes to as few as 28 (56 printable characters in the S-record).
Checksum	2	The least significant byte of the one's complement of the sum of the values represented by the pairs of characters making up the record length, address, and the code/data fields.

When downloading S-records, each must be terminated with a CR. Additionally, an S-record may have an initial field that fits other data such as line numbers generated by some time-sharing systems. The record length (byte count) and checksum fields ensure transmission accuracy.

A.2 S-Record Types

There are eight types of S-records to accommodate the encoding, transportation, and decoding functions. The various Motorola record transportation control programs (e.g. upload, download, etc.), cross assemblers, linkers, and other file creating or debugging programs, only utilize S-records serving the program's purpose. For more information on support of specific S-records, refer to the user's manual for that program.

An S-record format module may contain S-records of the following types:

- S0 The header record for each block of S-records. The code/data field may contain any descriptive information identifying the following block of S-records. The header record can be used to designate module name, version number, revision number, and description information. The address field is normally zeros.
- S1 A record containing code/data and the 2-byte address at which the code/data is to reside.
- S2 A record containing code/data and the 3-byte address at which the code/data is to reside.
- S3 A record containing code/data and the 4-byte address at which the code/data is to reside.
- S5 A record containing the number of S1, S2, and S3 records transmitted in a particular block. This count appears in the address field. There is no code/data field.
- S7 A termination record for a block of S3 records. The address field may optionally contain the 4-byte address of the instruction to which control is to be passed. There is no code/data field.
- S8 A termination record for a block of S2 records. The address field may optionally contain the 3-byte address of the instruction to which control is to be passed. There is no code/data field.
- S9 A termination record for a block of S1 records. The address field may optionally contain the 2-byte address of the instruction to which control is to be passed. If this address is not specified, the first entry point specification encountered in the object module input will be used. There is no code/data field.

Each block of S-records uses only one termination record. S7 and S8 records are only active when control passes to a 3- or 4-byte address; otherwise, an S9 is used for termination. Normally, there is only one header record, although it is possible for multiple header records to occur.

A.3 S-Record Creation

Dump utilities, debuggers, or cross assemblers and linkers produce S-record format programs. Programs are available for downloading or uploading a file in S-record format from a host system to a microprocessor-based system.

A typical S-record format module is printed or displayed as follows:

```
S00600004844521B
S1130000285F245F2212226A000424290008237C2A
S11300100002000800082629001853812341001813
S113002041E900084E42234300182342000824A952
S107003000144ED492
S9030000FC
```

The module has an S0 record, four S1 records, and an S9 record. The following character pairs comprise the S-record format module.

S0 Record:

S0 S-record type S0, indicating that it is a header record
 06 Hexadecimal 06 (decimal 6), indicating that six character pairs (or ASCII bytes) follow
 0000 A 4-character, 2-byte address field; zeros in this example
 48 ASCII H
 44 ASCII D
 52 ASCII R
 1B The checksum

First S1 Record:

S1 S-record type S1, indicating that it is a code/data record to be loaded/verified at a 2-byte address
 13 Hexadecimal 13 (decimal 19), indicating that 19 character pairs, representing 19 bytes of binary data, follow
 0000 A 4-character, 2-byte address field (hexadecimal address 0000) indicating where the data that follows is to be loaded.

The next 16 character pairs of the first S1 record are the ASCII bytes of the actual program code/data. In this assembly language example, the program hexadecimal opcodes are sequentially written in the code/data fields of the S1 records.

Opcode	Instruction
285F	MOVE.L (A7) +, A4
245F	MOVE.L (A7) +, A2
2212	MOVE.L (A2), D1
226A0004	MOVE.L 4(A2), A1
24290008	MOVE.L FUNCTION(A1), D2
237C	MOVE.L #FORCEFUNC, FUNCTION(A1)

The rest of this code continues in the remaining S1 record's code/data fields and stores in memory location 0010, etc.

2A The checksum of the first S1 record.

The second and third S1 records also contain hexadecimal 13 (decimal 19) character pairs and end with checksums 13 and 52, respectively. The fourth S1 record contains 07 character pairs and has a checksum of 92.

S9 Record:

S9 S-record type S9, indicating that it is a termination record
 03 Hexadecimal 03, indicating that three character pairs (3 bytes) follow

0000 Address field, zeros
 FC Checksum of the S9 record

Each printable character in an S-record encodes in hexadecimal (ASCII in this example) representation of the binary bits that transmit. Figure A-2 illustrates the sending of the first S1 record. Table A-2 lists the ASCII code for S-records.

Type	Record Length		Address				Code/Data								Checksum															
S	1	3	0	0	0	0	2	8	5	F	**	**	2	A																
5	3	3	1	3	1	3	3	3	0	3	0	3	0	3	0	3	2	3	8	3	5	4	6	**	**	3	2	4	1	
01	00	00	00	00	00	00	00	00	00	00	00	00	00	00	00	00	00	00	10	00	01	01	01	01	**	**	00	00	01	00
01	11	11	01	11	01	11	11	11	00	11	00	11	00	11	00	11	10	11	00	11	01	00	10	**	**	11	10	00	01	

Figure A-2. Transmission of an S1 Record

Table A-2. ASCII Code

Least Significant Digit	Most Significant Digit							
	0	1	2	3	4	5	6	7
0	NUL	DLE	SP	0	@	P	'	p
1	SOH	DC1	!	1	A	Q	a	q
2	STX	DC2	"	2	B	R	b	r
3	ETX	DC3	#	3	C	S	c	s
4	EOT	DC4	\$	4	D	T	d	t
5	ENQ	NAK	%	5	E	U	e	u
6	ACK	SYN	&	6	F	V	f	v
7	BEL	ETB	'	7	G	W	g	w
8	BS	CAN	(8	H	X	h	x
9	HT	EM)	9	I	Y	i	y
A	LF	SUB	*	:	J	Z	j	z
B	VT	ESC	+	;	K	[k	{
C	FF	FS	,	<	L	\	l	
D	CR	GS	-	=	M]	m	}
E	SO	RS	.	>	N	^	n	~
F	SI	US	/	?	O	_	o	DEL

Index

A

- Access control registers (ACR0–ACR3) 1-14
- Accumulator
 - EMAC 1-9
 - extensions (ACCext01, ACCext23) 1-10
- Address register
 - direct mode 2-3
 - general (A0–A7) 1-2
 - indirect mode
 - displacement 2-5
 - postincrement 2-4
 - predecrement 2-4
 - regular 2-3
 - scaled index and 8-bit displacement 2-6
- Address space identifier (ASID) 1-13

B

- Bit manipulation instructions 3-10
- Branch/set on unordered (BSUN) 11-7

C

- Cache
 - control register (CACR) 1-13
 - maintenance instructions 3-12
- Condition code register (CCR) 1-2
- Conditional testing 7-3

D

- Data formats
 - and type summary 1-17
 - multiply accumulate 1-19
- Data movement instructions 3-4
- Data register
 - direct mode 2-3
 - general (D0–D7) 1-2
- Data, immediate 2-9
- Divide-by-zero (DZ) 11-10

E

- EMAC
 - accumulators 1-9
 - user instructions 6-1–6-32
 - user programming model 1-8
- Exception processing model V4 changes 11-11

- Exception stack frame definition 11-4
- Exceptions
 - floating-point arithmetic 11-5
 - processor 11-5

F

- Floating-point
 - arithmetic exceptions 11-5
 - arithmetic instructions 3-8
 - control register (FPCR) 1-4
 - data formats 1-16
 - data registers (FP0–FP7) 1-4
 - data types
 - denormalized numbers 1-17
 - not-a-number 1-17
 - zeros 1-16
 - instruction
 - address register (FPIAR) 1-6
 - descriptions 7-11–7-45
 - status register (FPSR) 1-5, 7-1
- Formats
 - floating-point data 1-16
 - integer data 1-15
- FPU
 - programming model
 - differences 7-7
- FPU user programming model 1-3

I

- Inexact result (INEX) 11-10
- Infinities 1-16
- Input
 - denormalized number 11-8
 - not-a-number (INAN) 11-7
- Instructions
 - bit manipulation 3-10
 - cache maintenance 3-12
 - data movement 3-4
 - floating-point arithmetic 3-8
 - format 2-1
 - integer arithmetic 3-6
 - logical 3-9
 - program control 3-5
 - results, exceptions 7-6
 - set 3-19

- additions 3-12
- shift 3-9
- summary 3-1
- system control 3-11
- Integer arithmetic instructions 3-6
- Integer data formats
 - general 1-15
 - in memory 1-20
 - in registers 1-19
- Integer unit user programming model 1-2
- Integer user instructions 4-1–4-87

L
Logical instructions 3-9

M

MAC

- accumulator (ACC) 1-7
- mask register (MASK)
 - EMAC 1-10
 - MAC 1-7
- status register (MACSR)
 - EMAC 1-8
 - MAC 1-7
- user instructions 5-1–5-16
- user programming model 1-6

MC680x0 differences 7-7

Memory integer data formats 1-20

MMU base address register (MMUBAR) 1-14

Modes

- address register
 - indirect
 - postincrement 2-4
 - regular 2-6
 - indirect with displacement 2-5
- addressing
 - absolute long 2-9
 - absolute short 2-8
- direct
 - address register 2-3
 - data register 2-3
- effective addressing 2-2, 2-10
- indirect
 - address register 2-3
 - predecrement address register 2-4
 - program counter 2-6, 2-7

Module base address register (MBAR) 1-15

Multiply accumulate data formats 1-19

N

Normalized numbers 1-16

O

- Operand error (OPERR) 11-8
- Operation code map 9-1
- Organization of data in registers 1-19
- Overflow (OVFL) 11-9

P

Processor

- cross-reference 3-19–??
- exceptions 11-5

Program control instructions 3-5

Program counter (PC)

- general 1-2
- indirect
 - displacement 2-6
 - scaled index and 8-bit displacement 2-7

Programming model

- EMAC user 1-8
- FPU user 1-3
- integer unit user 1-2
- MAC user 1-6
- supervisor 1-11

R

RAM base address registers
(RAMBAR0/RAMBAR1) 1-14

Registers

- ABLR/ABHR 8-19
- access control (ACR0–ACR3) 1-14
- address (A0–A7) 1-2
- cache control (CACR) 1-13
- condition code (CCR) 1-2
- data (D0–D7) 1-2
- data organization 1-19
- DBR/DBMR 8-19
- floating-point
 - control (FPCR) 1-4
 - data (FP0–FP7) 1-4
 - instruction address (FPIAR) 1-6
 - status 7-1
 - status (FPSR) 1-5
- integer data formats 1-19
- MAC mask (MASK)
 - EMAC 1-10
 - MAC 1-7
- MAC status (MACSR)
 - EMAC 1-8
 - MAC 1-7
- MMU base address (MMUBAR) 1-14
- module base address (MBAR) 1-15
- RAM base (RAMBAR0/RAMBAR1) 1-14
- ROM base address (ROMBAR0/ROMBAR1) 1-14

status (SR) 1-12
vector base (VBR) 1-13, 11-2
ROM base address registers
(ROMBAR0/ROMBAR1) 1-14

S

Shift instructions 3-9
S-record
 content 1-1
 creation 1-2
 types 1-1
Stack 2-10
Stack pointers supervisor/user 1-13, 11-3
Status register (SR) 1-12
Supervisor
 instruction descriptions 8-1–8-19
 instruction set 10-7
 programming model 1-11
Supervisor/user stack pointers 1-13, 11-3
System control instructions 3-11

U

Underflow (UNFL) 11-9
User instruction set 10-1–10-7

V

Vector base register 1-13, 11-2



Introduction	1
Addressing Capabilities	2
Instruction Set Summary	3
Integer User Instructions	4
MAC User Instructions	5
EMAC User Instructions	6
FPU User Instructions	7
Supervisor Instructions	8
Instruction Format Summary	9
PST/DDATA Encodings	10
Exception Processing	11
S-Record Output Format	A
Index	IND

1	Introduction
2	Addressing Capabilities
3	Instruction Set Summary
4	Integer User Instructions
5	MAC User Instructions
6	EMAC User Instructions
7	FPU User Instructions
8	Supervisor Instructions
9	Instruction Format Summary
10	PST/DDATA Encodings
11	Exception Processing
A	S-Record Output Format
IND	Index